



This is a digital copy of a book that was preserved for generations on library shelves before it was carefully scanned by Google as part of a project to make the world's books discoverable online.

It has survived long enough for the copyright to expire and the book to enter the public domain. A public domain book is one that was never subject to copyright or whose legal copyright term has expired. Whether a book is in the public domain may vary country to country. Public domain books are our gateways to the past, representing a wealth of history, culture and knowledge that's often difficult to discover.

Marks, notations and other marginalia present in the original volume will appear in this file - a reminder of this book's long journey from the publisher to a library and finally to you.

### **Usage guidelines**

Google is proud to partner with libraries to digitize public domain materials and make them widely accessible. Public domain books belong to the public and we are merely their custodians. Nevertheless, this work is expensive, so in order to keep providing this resource, we have taken steps to prevent abuse by commercial parties, including placing technical restrictions on automated querying.

We also ask that you:

- + *Make non-commercial use of the files* We designed Google Book Search for use by individuals, and we request that you use these files for personal, non-commercial purposes.
- + *Refrain from automated querying* Do not send automated queries of any sort to Google's system: If you are conducting research on machine translation, optical character recognition or other areas where access to a large amount of text is helpful, please contact us. We encourage the use of public domain materials for these purposes and may be able to help.
- + *Maintain attribution* The Google "watermark" you see on each file is essential for informing people about this project and helping them find additional materials through Google Book Search. Please do not remove it.
- + *Keep it legal* Whatever your use, remember that you are responsible for ensuring that what you are doing is legal. Do not assume that just because we believe a book is in the public domain for users in the United States, that the work is also in the public domain for users in other countries. Whether a book is still in copyright varies from country to country, and we can't offer guidance on whether any specific use of any specific book is allowed. Please do not assume that a book's appearance in Google Book Search means it can be used in any manner anywhere in the world. Copyright infringement liability can be quite severe.

### **About Google Book Search**

Google's mission is to organize the world's information and to make it universally accessible and useful. Google Book Search helps readers discover the world's books while helping authors and publishers reach new audiences. You can search through the full text of this book on the web at <http://books.google.com/>

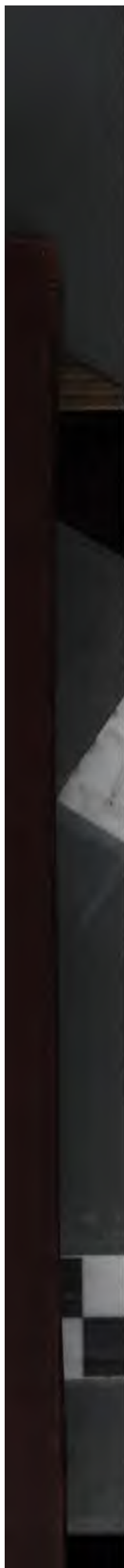











Clarendon Press Series

GEODESY

CLARKE

OX B

*Surveying*

~~589~~



London  
HENRY FROWDE



OXFORD UNIVERSITY PRESS WAREHOUSE  
AMEN CORNER, E.C.

Clarendon Press Series

# GEODESY

BY

COLONEL *Clarke* A. R. CLARKE, C.B.

ROYAL ENGINEERS; F.R.S; HON. F.C.P.S.

CORRESPONDING MEMBER OF THE IMPERIAL ACADEMY OF SCIENCES  
OF ST. PETERSBURG

NEW YORK  
PUBLIC  
LIBRARY

Oxford

CLARENDON PRESS

DLXXX 123  
1898

- 14618 -



ROY WOOD  
JUN 1893  
YARBU

## PREFACE

THE Essay entitled 'Figure of the Earth,' by Sir G. B. Airy, in the *Encyclopedia Metropolitana*, is the only adequate treatise on Geodetic Surveys which has been published in the English language, and though now scarce, it will ever remain valuable both on account of the historic research it contains, and the simple and lucid exposition of the mechanical theory there given. Since the date of its publication however have appeared many important volumes,—scientific, descriptive, official,—such as Bessel's *Gradmessung in Ostpreussen*; Colonel Everest's *Account (1847) of his Great Arc*; Struve's two splendid volumes descriptive of the trigonometrical chain connecting the Black Sea with the North Cape; the *Account of the Triangulation of the British Isles*; the *Publications of the International Geodetic Association*; recent volumes of the *Mémorial du Dépôt Général de la Guerre*; the *Yearly Reports of the United States Coast and Geodetic Survey*; the current volumes by General Ibañez, descriptive of the Spanish Triangulation, so remarkable for precision; and last, though not least, the five volumes recently published by General Walker, containing the details of Indian Geodesy.

The subject has thus of late years become a very large one, and although the present work does not go much into details, it is hoped it will to some extent fill a blank in our scientific literature. The Astronomical aspect of the science is but lightly touched on—for in this matter books are not wanting—we have for instance the works of Brünnow and Chauvenet, the last of which contains almost everything that can be required.

The once generally accepted ratio 298 : 299 of the earth's axes may be said to have disappeared finally on the publication (in 1858) of the investigation of the Figure of the Earth in the Account of the Triangulation of the British Isles, when it was replaced by 293 : 294. At the same time that this ratio is, in the present volume, still further altered in the same direction, the formerly received value of the ratio as deduced from pendulum observations is now altered from something like 288 : 289 up to the same figures as now represent meridian measurements, namely, about 292 : 293.

Thus, the disagreeable hiatus long supposed to exist between the result of actual meridian measurements and that deduced by Clairaut's Theorem from the actually observed variations of gravity on the surface of the earth, has now disappeared—thanks to the energetic labours of General Walker and his efficient staff of Officers.

A. R. CLARKE.

# CONTENTS.

## CHAPTER I.

### Geodetical Operations.

PAGE

Early Geodetic observers, Snellius, Picard, Cassini, Godin, Bouguer, and de la Condamine.—Maupertuis' Swedish measurements.—Labours of Bouguer and de la Condamine in Peru.—The Toise of Peru.—Connection of France and England by triangulation.—Ramsden's theodolite.—Measure of base line on Hounslow Heath.—The repeating circle.—The French Meridian Chain by Delambre and Mechain.—Borda's Rods.—Determination of the length of the legal metre.—Bessel's degree-measure in East Prussia.—Colonel Everest's Indian Arc.—Attraction of the range of mountains situated at the middle point of the arc.—Indian chain of triangulation continued by General Walker.—British triangulation.—Struve's Russian Arc of  $25^{\circ} 20'$ .—Sir Thomas Maclear's revision of Lacaille's Arc at the Cape of Good Hope . . . . . 1

## CHAPTER II.

### Spherical Trigonometry.

Fundamental equations of plane and spherical trigonometry.—Corresponding variations of sides and angles.—Right-angled triangles.—Legendre's Theorem, and its errors.—Spherical co-ordinates.—Expansion of  $(1 + 2n \cos \theta + n^2)^{-s}$  . . . . . 37

## CHAPTER III.

### Least Squares.

Method of least squares.—Law of facility of errors.—Mean and probable errors.—Solution of systems of equations, when the number of equations is greater than the number of unknown quantities.—Probable errors of the results.—Numerical examples.—Treatment of conditioned observations.—Probable error of a function of the corrected angles of a triangle . . . . . 52

## CHAPTER IV.

**Theory of the Figure of the Earth.**

PAGE

The potentials of confocal ellipsoids at an external point are as their masses.—Expressions for the potential of a nearly spherical ellipsoid at an internal and at an external point.—Potential of a spheroid formed of homogeneous spheroidal shells, whose density and ellipticity vary with their distance from the centre.—Jacobi's theorem on the equilibrium of a rotating fluid ellipsoid.—Equilibrium of a homogeneous rotating fluid spheroid.—Clairaut's differential equation connecting  $\rho$  and  $e$ .—Clairaut's Theorem.—Law of ellipticity of the strata resulting from Laplace's law of density.—Comparison of resulting ellipticity of surface with facts.—Irregularities of the earth's surface.—Disturbance of sea-level caused by irregular masses and mountain chains.—Theories of Sir G. B. Airy and Archdeacon Pratt as to the attraction of mountains.—Effect of altitude on an observed latitude . . . . . 66

## CHAPTER V.

**Distances, Azimuths, and Triangles on a Spheroid.**

Principal radii of curvature on a spheroid.—Mutual azimuths and zenith distances of two points on a spheroid.—Elements of a spheroidal triangle.—Of the various curves that may be taken as the sides of a spheroidal triangle.—The curve of alignment.—Curvature of surface.—Theory of spheroidal triangles.—Errors resulting from treating them as spherical . . . . . 102

## CHAPTER VI.

**Geodetic Lines.**

Characteristic of a Geodetic line.—Bessel's auxiliary spherical triangle.—Path of the Geodetic line between two points referred to a plane curve joining those points.—Azimuths of the Geodetic at its extremities.—Length of the Geodetic.—Numerical examples.—Geodetic joining Bordeaux and Nicolaëff.—Geodetic distance of Strasburg and Dunkirk . . . . . 124

## CHAPTER VII.

**Measurement of Base-Lines.**

Standards of length of different countries.—Thermometers and their errors.—Flexure.—Coefficients of expansion.—Personal errors in observing.—Values of various Geodetic standards, expressed in terms of the

	PAGE
Standard Yard of England.—Length of the Metre.—Struve's base apparatus.—Bessel's.—Colby's compensation apparatus.—The United States base-apparatus.—Apparatus of M. Porro.—Base of Madridejos.—Verification of the base by triangulation . . . . .	146

CHAPTER VIII.

**Instruments and Observing.**

Ramsden's theodolites.—Twenty-four inch theodolites of Troughton and Simms.—Theodolites used in India, in Russia, and in Spain.—Mode of observing.—Scaffoldings.—Airy's zenith sector.—The zenith telescope.—Portable transit-instrument; flexure; reduction of observations.—Transit in the vertical of Polaris.—Transit in the prime vertical.—Observations for latitude.—For azimuth.—Determination of differences of longitude by the American method.—Personal equation.—Transatlantic longitudes.—Indian longitudes.—Longitude of Algiers . . . . . 174

CHAPTER IX.

**Calculation of Triangulation.**

Calculation of a polygon formed by several triangles with a common vertex.—Numerical example, with probable errors of results.—Calculation of a chain of triangles, with one or two bases.—Probable error of an observed angle.—Geometrical equations of condition of a network of triangles.—Bessel's method of reduction by least squares.—Adaptation of this method to the British triangulation.—Probable errors of results.—Bases.—Numerical example of calculation of a small network.—Junction of triangulations of England and France.—Junction of triangulations of Spain and Algiers.—Method of treatment of crossing or closing chains as in the Indian Survey . . . . . 217

CHAPTER X.

**Calculation of Latitudes and Longitudes.**

Having given the latitude of *A*, the azimuth there of *B*, with the distance *AB*, to determine the latitude and longitude of *B* and the direction of the meridian there.—Numerical examples.—Distance of parallels of *A* and *B*.—Differentiation of such results with reference to the elements of the spheroid supposed variable.—Length of the parallel of  $52^\circ$  between the meridians of Valencia in Ireland and Mount Kemmel, in Belgium, on an indeterminate spheroid . . . . . 267



## CHAPTER XI.

**Heights of Stations.**

PAGE

Terrestrial refraction.—Coefficient of refraction.—Value obtained from observations in this country.—Difference of height obtained from observed zenith distances.—Reduction of involved observations by least squares.—Distance of the sea horizon.—Condition of the mutual visibility of two stations . . . . . 280

## CHAPTER XII.

**Connection of Geodetic and Astronomical Operations.**

Effect of irregularities of the earth's surface on an observed latitude, an observed longitude, and an observed azimuth.—The effect of the same on the observed angles of triangles.—Determination of an ellipsoid which satisfies most nearly the astronomical observations made in a triangulation.—Ellipsoid representing the surface of Great Britain and Ireland, and the residual errors.—Apparent errors to be expected from the form of the ground around an astronomical station.—Attraction caused by mountain ranges and table-lands.—Effect of mountain attraction on the operations of spirit-levelling.—Mean density of the earth . . . . . 287

## CHAPTER XIII.

**Figure of the Earth.**

Determination of the figure of the earth by Airy.—By Bessel.—By Clarke.—Determination of an ellipsoidal figure, and position of the axes.—Influence of the different arcs in the determinations of the semi-axes of the spheroid most nearly representing the earth.—Introduction of the Indian longitudes into the problem.—Final equations for the determination of the spheroid.—Values of the semi-axes and residual corrections to latitudes.—Comparison of the figures of the individual arcs with that of the spheroid.—Length of a degree of latitude and of longitude.—True length of the ideal metre . . . . . 302

## CHAPTER XIV.

**Pendulums.**

Of the earlier pendulum observers, Picard, Richer, Bouguer.—Bouguer's reduction of his observations.—His formula for mountain attraction as influencing the movement of the pendulum.—Maupertuis' observations in

CONTENTS.

xi

	PAGE
Finland.—Borda's apparatus.—Kater's reversible or convertible pendulum for determining the absolute length of the seconds pendulum.—His invariable pendulum.—Observation of coincidences.—Reduction of results to an infinitely small arc of vibration.—Bessel's investigations.—Repsold's form of pendulums.—Observations of Sabine and Foster.—Russian pendulum observations.—Indian series by Basevi and Heaviside, with two invariable pendulums.—Corrections for height of station, and the attraction of the underlying strata.—Summary of observed vibration numbers.—Determination of the ellipticity. . . . .	323
NOTES AND ADDITIONS . . . . .	351

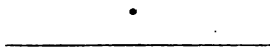



## CHAPTER I.

### OBSERVATIONS.

#### ADDITIONAL EXAMPLES

- Exp 7. In 1734, from the summit of Ben Nevis, the depression of the sea horizon was found to be  $1^{\circ} 4' 48''$ . The height of the hill is 4406 feet. Find the radius of the earth.
- Exp 8. A person standing on a cliff 100 feet high, observes the horizon at a distance of 10 miles. Find the radius of the earth.
- Exp 9. A person standing on a cliff 100 feet high, observes the horizon at a distance of 10 miles. Find the radius of the earth.
- Exp 10. A person standing on a cliff 100 feet high, observes the horizon at a distance of 10 miles. Find the radius of the earth.
- Exp 11. A person standing on a cliff 100 feet high, observes the horizon at a distance of 10 miles. Find the radius of the earth.

measure, namely, the depression of the horizon. This is an experiment that was made at Mount Edgecombe more than two centuries ago, and may have possibly been tried in other places. The depression of the sea horizon at the top of Ben Nevis is  $1^{\circ} 4' 48''$ ; this is the mean of eight observations taken with special precautions for the very purpose of this experimental calculation; the height of the hill is 4406 feet. Now let  $x$  be the radius of the earth,  $h$  the height of the hill, the tangent drawn from the observer's eye to the horizon subtends at the centre of the earth an angle equal to the depression; the length of the tangent is  $x \tan \delta$ , or with sufficient accuracy equal to  $h(2x+h)$ , or with sufficient accuracy for our purpose to  $2xh$ , hence  $x = 2h \cot^2 \delta$ . This is practically true, as the path of the horizon to the eye of the ob-

modern times by men of none have ever tended by the philosophers of al. That the surface of itself by simply observ- of a cliff near the sea, the horizon, and then the foot of the cliff the Assuming the earth to a more precise nature a value of the radius red is the dip or angle mbined with one linear cliff, will suffice for a

- ... 24, for  $\dots z_1 + \epsilon_1 = 0$  read  $\dots z_4 + \epsilon_4 = 0$ .
- „ 225, in the figure, for  $k$  read  $k_0$ .
- „ 238, 4th entry in last column, for  $-0.19$  read  $-1.19$ .
- „ 239, line 11 (from bottom), for 'corrections' read 'errors of observation.'

## CHAPTER I.

### GEODETICAL OPERATIONS.

OF the many discoveries made in modern times by men of science—astronomers and travellers—none have ever tended to shake the doctrine held and taught by the philosophers of ancient times that the earth is spherical. That the surface of the sea is convex anyone may assure himself by simply observing, say with a telescope from the top of a cliff near the sea, the appearance of a ship on or near the horizon, and then repeating a few moments after at the foot of the cliff the same observation on the same ship. Assuming the earth to be a sphere, a single observation of a more precise nature taken at the top of the cliff would give a value of the radius of the sphere. The observation required is the dip or angle of depression of the horizon: this, combined with one linear measure, namely, the height of the cliff, will suffice for a rough approximation. This is an experiment that was made at Mount Edgecombe more than two centuries ago, and may have possibly been tried in other places. The depression of the sea horizon at the top of Ben Nevis is  $1^{\circ} 4' 48''$ ; this is the mean of eight observations taken with special precautions for the very purpose of this experimental calculation; the height of the hill is 4406 feet. Now let  $x$  be the radius of the earth,  $h$  the height of the hill, the tangent drawn from the observer's eye to the horizon subtends at the centre of the earth an angle equal to the depression; call this angle  $\delta$ , then the length of the tangent is  $x \tan \delta$ . The square of this is equal to  $h(2x+h)$ , or with sufficient accuracy for our purpose to  $2xh$ , hence  $x = 2h \cot^2 \delta$ . But this formula is not practically true, as the path of the ray of light passing from the horizon to the eye of the observer is not a straight line,

but a curved one. But the laws of terrestrial refraction have been carefully studied, and we know that the value just written down for  $x$  should be multiplied by a certain constant: that is to say, the true equation is  $x = 1.6866 h \cot^2 \delta$ . This numerical co-efficient, obtained from a vast number of observations, is to be considered as representing a phenomenon of variable and uncertain amount. On substituting the values of  $h$  and  $\delta$  we obtain for the radius expressed in miles  $x = 3960$ . Now this is really very near the truth; but, except for the precaution of having made the observations at the proper hour of the day, the error might have been a hundred miles: in fact the method, though it serves for getting the size of the earth in round numbers, is totally inadequate for scientific purposes.

Amongst the early attempts to determine the radius of the earth, that of Snellius in Holland is remarkable as being the first in which the principle of measurement by triangulation was adopted. The account of this degree measure was published at Leyden in 1617. Half a century later, in France, Picard conceived the happy idea of adapting a telescope with cross wires in its focus to his angle measuring instruments. Armed with this greatly improved means of working, he executed a triangulation extending from Malvoisine, near Paris, to Amiens. From this arc, whose amplitude, determined with a sector of 10 feet radius, was  $1^\circ 22' 55''$ , he deduced for the length of a degree 57060 toises. The accuracy of this result however was subsequently found to be due to a compensation of errors.

One of the most important results of this measurement of Picard's was that it enabled Sir Isaac Newton to establish finally his doctrine of gravitation as published in the *Principia* (1687). In this work Newton proved that the earth must be an oblate spheroid, and, moreover, that gravity must be less at the equator than at the poles. Of this last proposition actual evidence had been obtained (1672) by the French astronomer, Richer, in the Island of Cayenne in South America, where he had been sent to make astronomical observations and to determine the length of the seconds' pendulum. Having observed that his clock there lost more than two

minutes a day as compared with its rate at Paris, he fitted up a simple pendulum to vibrate seconds, and kept it under observation for ten months. On his return to Paris he found the length of this seconds' pendulum to be less than that of the seconds' pendulum of Paris by  $1\frac{1}{2}$  line. This very important fact was fully confirmed shortly after by observations made at other places by Dr. Halley, MM. Varin and Des Hayes, and others.

Picard's triangulation was extended, between 1684 and 1718, by J. and D. Cassini, who carried it southwards as far as Collioure, and northwards to Dunkirk, measuring a base at either end. From the northern portion of the arc, which had an amplitude of  $2^{\circ} 12'$ , they obtained 56960 toises as the length of a degree, while the southern portion,  $6^{\circ} 19'$  in extent, gave 57097 toises. The immediate inference drawn by Cassini from this measure was that the earth is a prolate spheroid. A subsequent measurement by Cassini de Thuri, and Lacaille, of this same arc, proved the foregoing results to have been erroneous, and that the degrees in fact increase, not decrease, in going northwards (*Méridienne vérifiée en 1744*). Nevertheless the statement, on so great an authority as that of Cassini, that the earth is a prolate, not an oblate, spheroid, as maintained by Newton, Huygens, and others, found at the time many adherents, and on the question of the figure of the earth the scientific world was divided into hostile camps. The French, however, still maintained the lead in geodetical science, and the Academy of Sciences resolved to submit the matter to a crucial test by the measurement of an arc at the equator and another at the polar circle.

Accordingly, in May, 1735, the French Academicians, MM. Godin, Bouguer, and de la Condamine, proceeded to Peru, where, assisted by two Spanish officers, after several years of laborious exertions, they succeeded in measuring an arc of  $3^{\circ} 7'$ , intersected by the equator. The second party consisted of Maupertuis, Clairaut, Camus, Le Monnier, the Abbé Outhier, and Celsius, Professor of Astronomy at Upsal: these were to measure an arc of the meridian in Lapland.

It is not our intention to write a history of the geodetical operations which have been carried out at various times and



places; we shall, however, give a somewhat detailed account of the measurement in Lapland, partly because it was the one which first proved the earth to be an oblate spheroid, and also because it will at the same time serve the purpose of presenting a general outline of the method of conducting a geodetic survey.

The party of Maupertuis landed at the town of Tornea, which is at the mouth of the river of the same name at the northern extremity of the gulf of Bothnia, in the beginning of July, 1736. Having explored the river and found that its course was nearly North and South, and that there were high mountains on every side, they determined to establish their stations on these heights. The points selected are shown in the accompanying diagram, together with the course of the river Tornea. Taking the church of the town of Tornea as the southern extremity of the arc, the points were selected in the order—Niwa, *N*; Avasaxa, *A*; Horrila-kero, *H*; Kakama, *K*; Cuitaperi, *C*; Pullingi, *P*; Kittis, *Q*; Niemi, *N*; the north end of the base *B*; and the south end of the base *B*. The signals they constructed on the hill tops—which had first to be cleared of timber—were hollow cones composed of many large trees stripped of their bark and thus

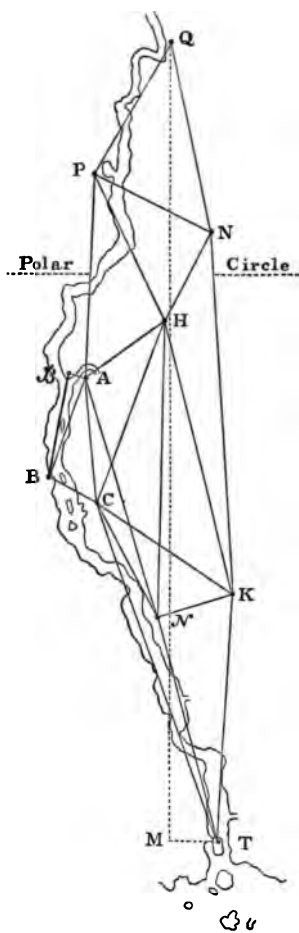

Fig. 1.

posed of many large trees stripped of their bark and thus

left white so as to be visible at ten or twelve leagues' distance. They took the precaution to cut marks upon the rocks, or drive stakes into the ground, so as to indicate precisely the centres of their stations, which could thus be recovered in case of any accident to the signal. Accurate descriptions of the stations are given in Outhier's work, entitled, *Journal d'un Voyage au Nord en 1736-37*. The arrangement of the stations in this triangulation, a heptagon in outline, having the base line at the middle of its length, is certainly very good, and they regarded it on its completion with pardonable satisfaction, remarking that it looked as if the placing of the mountains had been at their disposal. The angles were measured with a quadrant of two feet radius fitted with a micrometer. With respect to the accuracy of this instrument it is stated that they verified it a great many times round the horizon and always found that it gave the sum of the angles very nearly equal to  $360^\circ$ . In making the actual observations for the angles of the triangles they took care to place the instrument so that its centre corresponded with the centre of the station. Each observer made his own observation of the angles and wrote them down apart, they then took the means of these observations for each angle: the actual readings are not given, but the mean is. The three angles of every triangle were always observed, and, by way of check, several supernumerary angles—sums or differences of the necessary angles at any station—were also observed.

The measurement of the angles was completed in sixty-three days, and on September the 9th they arrived at Kittis and commenced to prepare the station for astronomical work. Two observatories were built; in one was a small transit instrument, having a telescope fifteen inches in length, placed precisely over the centre of the station, and a clock made by Graham. The second observatory, close by, contained the zenith sector, also made by Graham; the zenith sector was thus not over the centre of the trigonometrical station, but measurements were taken whereby the observations could be reduced to the trigonometrical station. The clock was regulated every day by corresponding altitudes of the sun. The astronomical observations to be made included a determination of absolute

azimuth, and this was effected by observing with the small telescope the times of transit of the sun over the vertical of Niemi in the south-east in the forenoon and over the vertical of Pullingi in the south-west in the afternoon. These observations were made on eight days, between September 30th and October 8th. The reduction of such observations requires the solution of a spherical triangle whose angular points correspond to the zenith, the pole, and the place of the sun; then are given the colatitude, the sun's north polar distance, and the hour angle of the sun—that is, the angle at the pole and the two adjacent sides are given, and from these is to be calculated the angle at the zenith, which is the required azimuth of the sun at the noted time of observation.

The zenith sector consisted of a brass telescope nine feet in length, forming the radius of an arc of  $5^{\circ} 30'$ , divided into spaces of  $7' 30''$ . The telescope, the centre to which the plumbline was hung, and the divided limb were all in one piece; the whole being suspended by two cylindrical pivots, which allowed it to swing like a pendulum in the plane of the meridian. One of these pivots ending in a very small cylinder at the exact centre of the divided limb and in its plane formed the suspension axis of the plumbline. The divided limb had a sliding contact with a fixed arc below, and this arc carried a micrometer against the pivot of which the limb of the sector was kept pressed by the tension of a thread. This micrometer screw, by communicating to the telescope and limb a slow movement in the plane of the meridian, served to subdivide the spaces of  $7' 30''$ . The instrument was not used to determine absolute zenith distances, but differences of zenith distance only. The observations of  $\delta$  Draconis, which passed close to the zenith, were commenced at Kittis on the 4th of October and concluded on the 10th. Leaving Kittis on the 23rd, they arrived at Tornea on the 28th, and commenced the observations of  $\delta$  Draconis on the 1st of November, finishing on the 5th. The observations of the star at both stations were made by daylight without artificially illuminating the wires of the telescope. The difference of the zenith distances, corrected for aberration,

precession, and nutation, gave the amplitude of the arc 57' 26".93.

It remained now to measure the base line, and this had been purposely deferred till the winter. The extremities of the base had been selected so that the line lay upon the surface of the river Tornea, which, when frozen, presented a favourable surface for measurement. They had brought with them from France a standard toise (known afterwards as the *Toise of the North*), which had been adjusted—together with a second toise, namely, that taken to Peru for the equatorial arc—to the true length at the temperature of 14° Reaumur. By means of this they constructed, in a room heated artificially to the temperature just mentioned, five wooden toises, the extremities of each rod being terminated in an iron stud, which they filed down until the precise length of the toise was attained. Having driven two stout nails into the walls of their rooms at a distance a trifle less than five toises apart, the five toises, placed upon trestles, were ranged in horizontal line in mutual contact between these nails, which were then filed away until the five toises just fitted the space between them. Thus the distance between the prepared surfaces of the nails became a five toise standard. By means of this standard they constructed for the actual measurement eight rods of fir, each five toises (about 32 feet) long, and terminated in metal studs for contact. Many experiments were made to determine the expansions of the rods by change of temperature, but the result arrived at was that the amount was inappreciable.

The measuring of the base was commenced on December 21st, a very remarkable day, as Maupertuis observes, for commencing such an enterprise. At that season the sun but just showed himself above the horizon towards noon; but the long twilight, the whiteness of the snow, and the meteors that continually blazed in the sky furnished light enough for four or five hours' work every day. Dividing themselves into two parties, each party took four rods, and two independent measurements of the line were thus made. This occupied seven days: each party measured every day the same number of toises, and the final difference between the two measurements

was four inches, on a distance of 8.9 miles. It is not stated how the rods were supported or levelled—probably they were merely laid in contact on the surface of the snow.

It was now an easy matter to get the length of the terrestrial arc. Calculating the triangles as plane triangles they obtained the distance between the astronomical observatories at Kittis and Tornea, and also the distance of Tornea from the meridian of Kittis. The length of this last enabled them to reduce the direct distance to the distance of the parallels of their terminal stations. The calculation of the distance was checked in various ways by the use of the supernumerary angles. The distance of parallels adopted was 55023.5 toises, which gave them, in connection with the observed amplitude, the length of one degree at the polar circle.

The absolute latitude of Tornea, as obtained from observations, made with two different quadrants on Polaris, was  $65^{\circ} 50' 50''$ , a result which did not however pretend to much precision.

The value they had obtained for the degree being much in excess of that at Paris showed decisively that the earth was an oblate and not a prolate spheroid. So great however was the difference of the two degrees that they resolved to submit the whole process to a most rigorous examination. It was concluded that the base line could not possibly be in error, considering the two independent measures: nor could the angles of the triangles, each of which had been observed so often and by so many persons, be conceived to be in error. They determined however to re-observe the astronomical amplitude, using another star, and also to observe the absolute azimuth at Tornea.

The maker of the zenith sector, Graham, had pointed out that the arc of  $5^{\circ} 30'$  was too small by  $3''.75$ : this they determined to verify for themselves during the winter at Tornea. The sector being placed in a horizontal position, two marks were fixed on the ice, forming with the centre of the sector a right-angled triangle. The distances, very carefully measured, were such that the angle of the triangle at the centre of the instrument was precisely  $5^{\circ} 29' 50''.0$ . The angle as observed with the instrument (and here there is a curious misprint in

Maupertuis's book) was  $5^{\circ} 29' 52''.7$ : this was a satisfactory check on Graham's  $3''.75$ . The  $15'$  spaces were all subsequently measured with the micrometer, and also those two particular spaces of one degree each on which the amplitudes depend were compared. The star selected for the second determination of the amplitude was  $\alpha$  Draconis—which passed only one quarter of a degree south of Tornea. The observations at Tornea were made on March 17th, 18th, 19th, and at Kittis on the 4th, 5th, 6th of April. The resulting amplitude was  $57' 30''.42$ .

The azimuth at Tornea was obtained on May 24th by an observation of the horizontal angle between the setting sun, at a known moment of time, and the signal at Niwa. Again the following morning—the sun was at that time of the year only about four hours between setting and rising—the angle was observed, at a given moment, between the rising sun and the signal of Kakama. Thus, by an easy calculation, the azimuths of these two stations were obtained. The result differed about  $34''$  from the azimuth as calculated from the observations that had been made at Kittis.

This difference in the azimuth would not make any material difference in the calculated length of the arc; and of the difference of  $3''.49$  between the two determinations of amplitudes, one second was due to the difference of the two degrees of the sector used respectively with  $\alpha$  and with  $\delta$  Draconis. Thus, the whole operations were concluded with the result that the length of the degree of the meridian which cuts the polar circle is  $57437.9$  toises.

Notwithstanding the appearance of a considerable amount of accuracy in Maupertuis's arc-measurement, yet there is a notable discordance between his terrestrial and astronomical work, as if either his arc were 200 toises too long, or his amplitude twelve seconds or so too small. In order to clear up this point, an expedition was organized and despatched from Stockholm in 1801, and the arc was remeasured and extended in that and the two following years by Svanberg. The account of this measurement was published in the work entitled *Exposition des Opérations faites en Laponie, &c.* par J. Svanberg, Stockholm, 1805. Svanberg succeeded fairly, though

not perfectly, in refinding the stations of Maupertuis, and verifies his terrestrial measurement: but taking for his own terminal points two new stations not in Maupertuis's arc, the amplitude obtained by the latter was not verified. The length of the degree which Svanberg obtained was about 220 toises less than that of Maupertuis.

The valley in which Quito is situated is formed by the double chain of mountains into which the grand Cordillera of the Andes is there divided, and which extends in a nearly south direction to Cuenca, a distance of some three degrees. This was the ground selected by MM. Godin, Bouguer, and de la Condamine as the theatre of their operations. These mountains, which, from their excessive altitude, were a source of endless fatigue and labour, offered however considerable facilities for the selection of trigonometrical stations—which, taken alternately on the one side of the valley and on the other, regulated the lengths of the sides and enabled the observers to form unexceptionally well-shaped triangles.

The chain of triangles was terminated at either end by a measured base line.

The northern base near Quito had a length of 7.6 miles: the altitude of the northern end was 7850 feet above the level

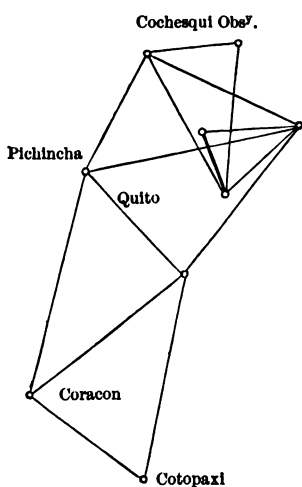

Fig. 2.

of the sea. This indeed is the lowest point in the work, seven of the signals being at elevations exceeding 14,000 feet. The accompanying diagram shows the northern triangles of the arc, extending as far south as Cotopaxi. The southern base was about 1000 feet above the northern, and had a length of 6.4 miles: it occupied ten days (August, 1739) in the measurement, while the northern, on rougher ground, took five-and-twenty (October, 1736). The measuring

rods used in the base measurement were twenty feet in length terminated at either end in copper plates for contact. Each measurement was executed in duplicate: the whole party being divided into two companies, which measured the line in opposite directions. The rods were always laid horizontally, change of level being effected by a plummet suspended by a hair or fine thread of aloe. The rods were compared daily during the measurement with a toise marked on an iron bar and which was kept duly shaded in a tent. This working standard, so to call it, had been laid off from the standard toise which they had brought from Paris. De la Condamine thus refers to his standard, which, known as the *Toise of Peru*, subsequently became the legal standard of France: 'Nous avons emporté avec nous en 1735 une règle de fer poli de dix-sept lignes de largeur sur quatre lignes et demie d'épaisseur. M. Godin aidé d'un artiste habile avoit mis toute son attention à ajuster la longueur de cette règle sur celle de la toise *étalon*, qui a été fixée en 1668 au pied de l'escalier du grand Châtelet de Paris. Je prevois que cet ancien étalon, fait assez grossièrement, et d'ailleurs exposé aux chocs, aux injures de l'air, à la rouille, au contact de toutes les mesures qui y sont présentées, et à la malignité de tout mal-intentionné, ne seroit guère propre à vérifier dans la suite la toise qui alloit servir à la mesure de la terre, et devenir l'original auquel les autres devoient être comparées. Il me parut donc très nécessaire, en emportant une toise bien vérifiée d'en laisser à Paris une autre de même matière et de même forme à laquelle on pût avoir recours s'il arrivoit quelqu'accident à la nôtre pendant un si long voyage. Je me chargeai d'office du soin d'en faire faire une toute pareille. Cette seconde toise fut construite par le même ouvrier, et avec les mêmes précautions que la première. Les deux toises furent comparées ensemble dans une de nos assemblées, et l'une des deux resta en dépôt à l'Académie: c'est la même qui a été depuis portée en Laponie par M. de Maupertuis, et qui a été employée à toutes les opérations des Académiciens envoyés au cercle Polaire.' Both the bases were measured at a mean temperature very nearly 13° Reaumur: 'C'est précisément celui que le thermomètre de M. de Reaumur marquoit à Paris en 1735, lorsque notre toise



de fer fut étalonée sur celle du Châtelet par M. Godin.' (*Mesure des trois premiers Degrés du Méridien par M. de la Condamine*, Paris, 1751, pp. 75, 85.) The difference between the two measures of the base in either case is said not to have exceeded three inches.

The quadrants, of from two to three feet radius, with which the angles of the triangles were observed were very faulty, and much time was spent in determining their errors of division and eccentricity. M. de la Condamine obtained a system of corrections for every degree of his instrument, and in only four of the thirty-three triangles as observed by him does the error of the sum of the observed angles amount to  $10''$ ; that is, after being corrected for instrumental errors. All the three angles of every triangle were observed, and each angle by more than one observer.

The azimuthal direction of the chain of triangles was determined from some twenty observations of the sun at various stations along the chain.

The determination of the latitudes cost them some years of labour. Their sectors of twelve and eight feet radius were found very defective, and they were virtually reconstructed on the spot. A vast number of observations were rejected, and the amplitude was finally adopted from simultaneous observations of  $\epsilon$  Orionis made by De la Condamine at Tarqui (the southern terminus) and Bouguer at Cotchesqui; the observations, extending from November 29th 1742, to January 15th 1743. By the simultaneous arrangement of the observations any unknown changes of place in the star were eliminated in the result.

The zenith sector was used in a different manner from that of Maupertuis. In his case the plumb-line indicated the direction of the telescope, or the star, at the one station and at the other; there was no attempt to ascertain the absolute zenith distance. In the observations in Peru the zenith sector was reversed in azimuth several times at each station, whereby the unknown reading of the zenith point was eliminated, and the double zenith distance of the star measured. The amplitude of the arc, as derived from  $\epsilon$  Orionis, they found to be  $3^{\circ} 7' 1'' \cdot 0$ . This was checked by

observations on  $\alpha$  Aquarii and  $\theta$  Aquilæ, which however they did not use,

From this and the length of the arc, namely, 176945 toises (at the level of their lowest point, and taking the mean of the two lengths calculated by Bouguer and De la Condamine), the length of the degree was ascertained to be 56753 toises.

Bouguer published his history of the expedition in a work entitled, *La figure de la Terre*, par M. Bouguer, Paris, 1749. The calculations of this arc were revised by Von Zach (*Mon. Corresp.* xxvi. p. 52), who finds the amplitude to be  $3^{\circ} 7' 3''.79$  and the terrestrial arc 176874 toises, reduced to the level of the sea. Delambre, by a revision of the reduction of the observations made with the zenith sector, obtained for the latitudes of Tarqui  $3^{\circ} 4' 31''.9$  S and of Cotchesqui  $0^{\circ} 2' 31''.22$  N, making the amplitude  $3^{\circ} 7' 3''.12$ .

In 1783, in consequence of a representation from Cassini de Thuri to the Royal Society of London on the advantages that would accrue to science from the geodetic connection of Paris and Greenwich, General Roy was with the King's approval appointed by the Royal Society to conduct the operations on the part of England,—Count Cassini, Mechain, and Legendre being appointed on the French side. The details of this triangulation, as far as concerns the English observers, are fully given in the *Account of the Trigonometrical Survey of England and Wales*, Vol. I. The French observations are recorded in the work entitled, *Exposé des Opérations faites en France en 1787 pour la jonction des Observatoires de Paris et Greenwich*: par MM. Cassini, Mechain, et Legendre.

A vast increase of precision was now introduced into geodesy. On the part of the French, the repeating circle was for the first time used; and in England Ramsden's theodolite of three feet diameter was constructed and used for measuring the angles of the triangles and the azimuth by observations of the Pole Star. The lower part of this instrument consists of the feet or levelling screws, the long steel vertical axis, and the micrometer microscopes—originally three in number—whereby the graduated circle is read, these being all rigidly connected. The next part above consists of the horizontal circle, the hollow vertical axis fitting on to the steel axis

before mentioned, and the transverse arms for carrying the telescope, all strongly united. The circle has a diameter of thirty-six inches, it is divided by dots into spaces of 15', which by the microscopes are divided into single seconds. The vertical axis is about two feet in height above the circle. The telescope has a focal length of thirty-six inches and a transverse axis of two feet in length, terminated in cylindrical pivots, about which, when supported above the axis of the theodolite, it is free to move in a vertical plane.

A second instrument almost identical in size and construction was shortly afterwards added. Both of them have done much service on the Ordnance Survey, having been used at most of the principal stations. Notwithstanding all the travelling and usage they have been subjected to for so many years, they are both now, with perhaps the exception of some very trifling repairs, as good as when they came from Ramsden's workshop. Fortunately no accident has ever happened to either of them, which is remarkable when we consider how many mountains they have ascended.

The measurement of a base on Hounslow Heath was the first step in the trigonometrical survey of Great Britain. The ground was selected from the extraordinary evenness of its surface and its great extent without any local obstructions to the measurement.

The bases which had been measured previously to that time in other countries had generally been effected with deal rods. Accordingly, three such rods, twenty feet each in length and of the finest material, were obtained; they were terminated each in bell-metal tips, by the contact of which the measure was to be made; but it does not appear that they were oiled or varnished. In the course of the work it became obvious that the rods were affected to such an extent by the variations of humidity in the atmosphere that the measurement was considered a failure. The base was then measured with glass tubes of twenty feet in length, of which the expansions were determined by actual experiment. The temperature of each tube was obtained during the measurement from the readings of two thermometers in contact with it.

The length obtained from the glass tubes was 27404.0 feet

when reduced to the level of the sea and to the temperature of 62° Faht.

With respect to the reduction of the base to the level of the sea, what is meant is this: when we speak of the earth being a sphere or a spheroid we do not mean thereby that the external visible surface of the earth is such. What is intended is that the surface of the sea, produced in imagination so as to percolate the continents, is a regular surface of revolution. As trigonometrical operations are necessarily conducted on the irregular surface of the ground, it is usual to reduce the observations or measurements to what would have been obtained at corresponding points on the surface of the sea. If  $S$  be any actual trigonometrical station,  $s$  its projection on the surface of the sea, so that the line  $Ss = h$  is a normal to the water surface at  $s$ , then  $s$  is the point dealt with in all the calculations of triangulation.

In this light a base line should be measured along the level of the sea as  $ab$ , but practically the section of a base line will be always some uneven line as  $AB$ . Generally, it will be measured in a succession of small horizontal portions as indicated in the diagram: we may suppose each horizontal portion to be a measuring rod. If  $l$  be the length of a rod and  $r$  the radius of the earth, then the length of the projection of  $l$  on  $ab$  by lines drawn to the centre of the earth is clearly

$$\frac{l r}{r + h} = l - l \frac{h}{r};$$

summing this from one end of the base to the other, we see that if  $i$  be the number of measuring rods in the base and  $il = L$ , then the length of the base as reduced to the level of the sea  $ab$  is

$$\mathfrak{L} = L - \frac{L}{r} \cdot \frac{\Sigma(h)}{i}.$$

For the reduction of the base it is necessary then that the



Fig. 3.

height of every portion of the base be known, in order to get the mean height of the line.

To return to the measurement of the base at Hounslow. It was considered that the length obtained by the glass tubes ought to be verified, and it was decided to remeasure the line with a steel chain. For this purpose two chains of a hundred feet long were prepared by Ramsden. Each chain consisted of forty links, half an inch square in section, the handles were of brass, perfectly flat on the under side; a transverse line on each handle indicated the length of the chain. One chain was used for measuring; the other was reserved as a standard.

At every hundred feet of the base was driven a post carrying on its upper surface a graduated slider, moveable in the direction of the base by a slow-motion screw; this post served to indicate, by a division on the scale or slider, the end of one chain and the initial point of the next. The chain, stretched by a weight of twenty-eight pounds, was laid out in a succession of five deal coffers carried on trestles, so that the handles of the chain rested upon two of the posts, or on the divided scales attached thereto. The final result exceeded by only some two inches that obtained from the glass tubes.

The instrument introduced in these operations by the French for the measurement, not only of terrestrial angles, but for astronomical work, was one constructed on a principle pointed out by *Tobias Mayer*, professor in the University of Gottingen, in *Commentarii Societatis Regiae Scientiarum, Gotting.* 1752. The repeating circle, used then and for many years after to the exclusion of every other kind of instrument for geodetical purposes in France, soon attained an immense reputation, and was adopted in nearly every country of continental Europe, where precise results were desired. It was, however, never used in England. The aim of the principle of repetition was to eliminate errors of division, a class of errors which was certainly large at that time. But, as the art of dividing circles attained gradually to higher perfection, so the value of the repeating circle diminished. Besides it was found by pretty general experience that the instrument was liable to constant error, of which the origin was not explained satisfactorily.

The repeating circle has a tripod stand, with the usual levelling foot-screws, and a long vertical axis, at the base of which is a small azimuthal circle, which, however, is only a subordinate part of the instrument. At its upper extremity this vertical axis of rotation carries—on a kind of fork—a short horizontal axis, to which are united on opposite sides of it the repeating circle and its counterpoise; the axis of rotation of the circle itself passing from the one to the other. By rotation round the horizontal axis the circle can be set at any inclination between the limits of horizontality and verticality; this, combined with azimuthal rotation round the long vertical axis, allows the circle to be brought into any plane whatever. The circle, which is divided on one surface only, is fitted with two telescopes; the upper telescope carries with it four verniers for reading the angles; the lower telescope carries no verniers, and is mounted eccentrically; the optical axis of each telescope is parallel to the plane of the circle. Moreover each telescope rotates round an axis coincident with that of the circle, and each may be independently clamped to the circle.

The process of measuring an angle between two terrestrial objects is this; let  $R$  and  $L$  designate respectively the right and left objects. The first thing is to bring the plane of the circle to pass through  $R$  and  $L$ . Suppose, to fix the ideas, that the divisions of the circle read from left to right (this was the French practice and is contrary to ours). (1) Having set and clamped the upper telescope at zero, the circle is turned in its own plane until  $R$  is bisected by the upper telescope, then the circle is clamped. (2) The circle and upper telescope remaining fixed, the lower telescope is brought to bisect  $L$  and then clamped to the circle; this is the first part of the operation. (3) Without deranging the telescopes the circle is unclamped and rotated in its own plane until the lower telescope comes to  $R$  and bisects it; then the circle is clamped. Thus the upper telescope has been moved away from  $R$  in the opposite direction to  $L$ , and by an amount equal to the angle to be measured. (4) The upper telescope is now unclamped and directed to  $L$  where it is clamped. If now the verniers be read it is clear that they indicate

double the angle between *R* and *L*. This compound operation is repeated as many times as may be thought necessary, starting always from the point where the upper telescope has arrived at the close of the preceding double measure. It is hardly necessary to remark that the clamps are accompanied by the ordinary tangent screws.

It is only necessary to read the circle at the commencement and at the end of the repetitions, keeping account of the number of total circumferences passed over. Then the resulting angle, which may be many thousands of degrees, is divided by the number of repetitions; thus the error of reading and of graduation is divided by so large a number that it is practically eliminated.

There are, however, other sources of error at work; the whole apparatus is not rigid as it is in theory supposed to be, and the play of the several axes doubtless affects the work with some constant error. Moreover it is a principle in observing generally, that to repeat the same observation over and over, under precisely the same circumstances, is a mere waste of time, the eye itself seems to take up under such circumstances a fixed habit of regarding the object observed, and that with an error which is for the time uniform. In some repeating circles a tendency has been found in the observed angle to continually increase or decrease as the number of repetitions was increased.

W. Struve, in his account of his great arc in Russia, observes that if in measuring an angle the repetition be made first in the ordinary direction, and then again by reversing the direction of rotation of the circle, the two results differ systematically. Accordingly it became the practice to combine in measuring an angle rotations in both directions. Nevertheless there was no certainty that even then the error was eliminated, and the method of repetition was soon abandoned.

In March, 1791, the Constituent Assembly of France received and sanctioned a project of certain distinguished members of the Academy of Sciences, Laplace and Lagrange being of the number, to the effect that a ten-millionth part of the earth's meridian quadrant should thereafter be adopted as the national standard of length, to be called the metre.

The length was to be determined by the immediate measure of an arc of the meridian from Dunkirk to Barcelona, comprehending  $9^{\circ} 40'$  of latitude, of which  $6^{\circ}$  were to the north of the mean latitude of  $45^{\circ}$ . This measurement was to include the determination of the difference of latitude of Dunkirk and Barcelona, and other astronomical observations that might appear necessary; also the verification by new observations of the angles of the triangles which had been previously employed; and to extend them to Barcelona. The length of the seconds' pendulum in latitude  $45^{\circ}$  was also to be determined, and some other matters.

Delambre was appointed to the northern portion of the arc, Mechain to the southern; each was supplied with two repeating circles made by Lenoir, and the work was commenced in June, 1792. The angles of all the triangles from Dunkirk to Barcelona were observed with repeating circles, and absolute azimuths were determined at Watten (a station adjacent to Dunkirk), Paris, Bourges, Carcassonne, and Montjouy. The sun was used in these determinations, in the evenings and mornings; the angle between the sun and selected trigonometrical stations being observed at recorded moments of time. The observations are numerous; at Paris there are as many as 396, yet between that station and Bourges (120 miles south), where there were 180 observations, the discrepancy between the observed azimuths is as much as  $39''.4$ . Delambre could not explain the discrepancies between his observed azimuths, but consoled himself with the reflection that a somewhat large error of azimuth did not materially influence the result he obtained for the distance between the parallels of Dunkirk and Barcelona.

The latitudes were determined by zenith distances, principally of  $\alpha$  and  $\beta$  Ursæ Minoris, at Dunkirk, Paris, Evaux, Carcassonne, Barcelona, and Montjouy.

The length of the terrestrial arc was determined from two measured lines, one at Melun, near Paris, the other at Carcassonne—each about seven and a quarter miles long. The measuring rods were four in number, each composed of two strips of metal in contact, forming a metallic thermometer, carried on a stout beam of wood. The lower strip is of



platinum, two toises in length, half an inch in width, and a twelfth of an inch in thickness. Lying immediately on this is a strip of copper shorter than the platinum by some six inches. The copper strip is fixed to the platinum at one extremity by screws, but at the other end, and over its whole length, it is free to move as its relative expansion requires along the platinum strip. A graduated scale at the free end of the copper, and a corresponding vernier on the platinum, indicate the varying relative lengths of the copper, whence it is possible to infer the temperature and the length of the platinum strip. At the free end of the latter, where it is not covered by the copper, there is a small slider fitted to move longitudinally in a groove, so forming a prolongation to the length of the platinum; the object of this slider, which is graduated and read by help of a vernier, is to measure the interval between the extremity of its own platinum strip and that of the next following in the measurement. Both the verniers mentioned are read by microscopes.

In the measurement each rod was supported on two iron tripods fitted with levelling screws, and the inclination of the rod was obtained by means of a graduated vertical arc of  $10^\circ$ , with two feet radius, furnished with a level and applied in reversed positions. The whole apparatus was constructed by M. de Borda.

The rod marked No. 1 was compared by Borda with the Toise of Peru, not directly, but by means of two toises which had been frequently compared with that standard; so that all the lengths in the French arc are expressed in terms of the Toise of Peru at the temperature of  $16^\circ.25$  Cent. =  $13^\circ$  Reaumur. The rod No. 1 was not after Delambre's time used in measuring bases, but was retained by the Bureau des Longitudes as a standard of reference.

The Commission appointed to examine officially the work of Delambre and Mechain, and to deduce the length of the metre, after having verified all the calculations, determined the length of the meridian quadrant from the data of this new French arc combined with the arc in Peru. For the French arc they had obtained a length of 551584.7 as comprised between the parallels of Dunkirk and Montjoux, with an

amplitude of  $9^{\circ} 40' 25''$ ; the latitude of the middle of the arc being  $46^{\circ} 11' 58''$ . For the arc of Peru they took (according to Delambre's statement) Bouguer's figures, namely, 176940—67, that is 176873 as the length reduced to the level of the sea, with an amplitude of  $3^{\circ} 7' 1''$ , the latitude of the middle being  $1^{\circ} 31' 0''$ .

It may be worth while here to go over, in an approximate manner, this historically interesting calculation. The latitude of a place on the surface of the earth, supposed an ellipsoid of revolution, is the angle the normal to the surface there makes with the plane of the equator. Let  $2A$  and  $2B$  be the sum and difference of the semiaxes of the elliptic meridian, which we suppose to be so nearly a circle that the square of the fraction  $B:A$  is to be neglected, then it is easy to show that the radius of curvature at a point whose latitude is  $\phi$  is

$$R = A - 3B \cos 2\phi,$$

Multiply this by  $d\phi$  and integrate from 0 to  $\frac{1}{2}\pi$ ; this gives for the length of the quadrant  $Q = \frac{1}{2}\pi A$ . If we know the radii of curvature at two points whose latitudes are  $\phi$  and  $\phi'$ , then we have two equations such as the above, and eliminating  $B$  between them, the result is—putting  $2\Sigma$ ,  $2\Delta$  for the sum and difference of the radii, and  $\sigma$ ,  $\delta$  for the sum and difference of the mean latitudes,

$$A = \Sigma + \Delta \cot \sigma \cot \delta.$$

If we divide the length of a short arc by its amplitude we get the radius of curvature at its centre: thus, from the numbers we have just given, the radii of curvature at the centres of the French and Peruvian arcs are respectively 3266978 and 3251285, thus  $\Sigma = 3259131$  and  $\Delta = 7846$ ,

$$\begin{aligned} \log 7846 & \dots 3.89465, \\ \log \cot(\sigma = 47^{\circ} 43') & \dots 9.95875, \\ \log \cot(\delta = 44^{\circ} 41') & \dots 0.00480, \\ \log 7214 & \dots 3.85820. \end{aligned}$$

Thus  $A = 3266345$ : this multiplied by  $\frac{1}{2}\pi$  and divided by 10,000,000 gives the length of the metre = .5130766 in parts of the toise of Peru. The toise is six French feet of twelve inches, and an inch is 12 'lignes,' thus the toise is  $864^l$ , and the metre consequently is  $443^l.298$ .

This is not the precise result attained by the Commission, as we have only made an approximate calculation; they obtained 443<sup>l</sup>.296, which is the authoritative length of 'The Metre.'

The history of these matters is given in full detail in the volumes entitled *Base du système métrique décimale*, by Delambre.

The final results for the French arc may be summed up as in this table:

STATIONS.	LATITUDES.	DISTANCE OF PARALLELS.
	° ' "	Toises
Dunkirk ... ..	51 2 8.85	124944.8
Pantheon (Paris)... ..	48 50 49.37	152293.1
Evvaux ... ..	46 10 42.54	168846.7
Carcassonne ... ..	43 12 54.30	104555.9
Barcelona ... ..	41 22 47.90	943.1
Montjoux ... ..	41 21 44.96	

This arc was subsequently extended by MM. Biot and Arago along the Spanish coast and terminated in the islands of Ivica and Formentera. The account of this undertaking will be found in the volume entitled *Recueil d'observations géodésiques astronomiques et physiques . . .*, par MM. Biot et Arago, Paris, 1821. As many as 3990 observations were made (1807, 1808) on  $\alpha$  and  $\beta$  Urs. Min. for the latitude of Formentera; but in consequence of doubts that had arisen as to the value of observations for latitude with the repeating circle when made on one side of the zenith only, the latitude was re-observed by Biot in 1825, taking stars north and south of the zenith. The north stars gave a latitude differing 7" from that given by the south stars in 880 observations, while in 180 observations the difference amounted to 12". The final result for the latitude of Formentera was 38° 39' 53".17. The distance of the parallels of Formentera and Montjoux as recomputed by Bessel (*Astron. Nachricht.* No. 438, p. 114) is 153673.6 toises.

The publication in 1838 of the work entitled *Gradmessung in Ostpreussen und ihre Verbindung . . .*, by F. W. Bessel, marks an era in the science of geodesy; the book itself, equally with the work of which it treats, being a model of precision.

The geodetical operation described is the measurement by Bessel himself and Major (now General) Baeyer of an oblique chain of triangles between Trunz and Memel, destined to connect the extensive triangulations of France, Hanover, Denmark, Prussia, Bavaria, and other countries to the west with that of Russia on the east. The annexed diagram shows the triangles, omitting the base line and its connection with the side Galtgarben-Königsberg. The side Trunz-Wildenhof is common to the Prussian triangulation: Memel-Lepaizi to the Russian. Whilst fulfilling the purpose of connecting

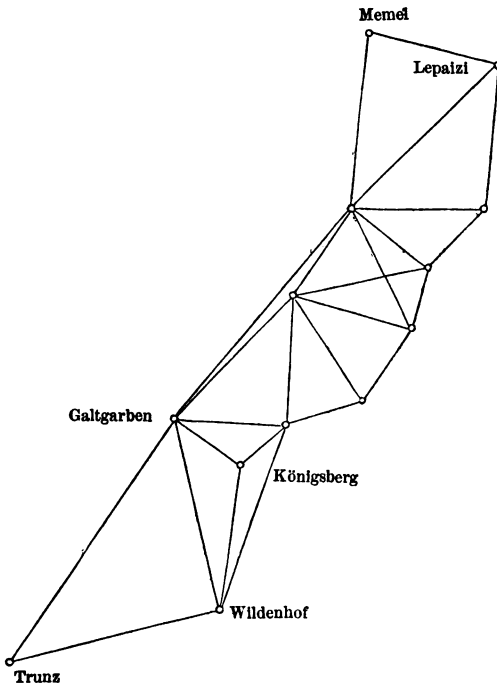

Fig. 4.

the triangulations named, besides giving the means of comparing the lengths and azimuths in the two triangulations, the chain of Bessel and Baeyer was in itself a degree measure, oblique indeed, but for that reason all the more valuable; for by observing the latitude and direction of the meridian at the extreme points both semiaxes of the terrestrial spheroid are

obtained. For the arc is equivalent to an arc of meridian and an arc perpendicular to the meridian combined, so that the curvature of the surface in the principal sections is known, and thence the values of the semiaxes follow.

The base line, only 935 toises in length, was measured with an apparatus very similar to that of Borda. The measuring rods, two toises in length, were four in number, each composed of a strip of iron and one of zinc, forming a thermometric combination. The very small interval forming the metallic thermometer was measured by means of a graduated glass wedge, as was also the interval left between two rods in the measuring of the base. The relative lengths of the rods and the values of the thermometric indications of each, were obtained from inter-comparisons, first with all the bars at a summer temperature, again with all at a winter temperature, and again in pairs at temperatures differing  $20^{\circ}$  Reaumur. The absolute lengths were obtained by comparisons of one of the rods with *Bessel's Toise*,—which had been constructed by Fortin as a copy of the Toise of Peru.

The extremities of the base were thus marked; a large block of granite was imbedded in a mass of brickwork below the surface of the ground; a hole pierced vertically in the granite was fitted with a cylinder of brass, the axis of which, shown by a fine cross engraved on the upper surface, marked the end of the base. The brickwork was then carried upwards above the surface to a height sufficient to form a support to the theodolite, and capped with a block of stone, into which was let another vertical cylinder having its axis in the same line with that of the first cylinder. In placing the theodolite over this mark precautions were taken preventing an error of as much as a hair-breadth. The centre marks and centering of the instrument over all the stations were matters of most careful consideration.

The signals for observing were of two kinds; the one consisted of a hemisphere of copper, silvered and polished, placed with its axis vertical and passing through the centre mark of the station. In sunshine a bright point or image of the sun is thus shown, forming a good object for observing; the position however of the bright spot varies with the time of day and requires

the calculation of a correction. The second form of signal was a board two feet square, painted white, with a black stripe down its centre, mounted with its plane vertical, so as to be capable of rotation round an axis which coincided with the centre of the black stripe and also with the vertical line through the centre mark of the station.

Two theodolites of 15 inches and 12 inches diameter were used for the horizontal angles. The manner of observing was this:—the theodolite being adjusted and levelled and the divided circle clamped, the telescope is turned to the first object, and the verniers of the horizontal circle read; the same is repeated in succession on each of the other points to be observed. On the termination of this first series, a repetition of the same in an inverted order immediately follows; the mean is taken of the pair of readings so obtained for each point. Then, changing the position of the zero of the circle by about  $15^\circ$ , a third and fourth series are taken in the same manner; again a shift of the zero  $15^\circ$  and a fifth and sixth series, and so on.

The smaller instrument was a repeating theodolite, and a few observations were made on that principle. The mean error of a single observation of a bearing with the larger theodolite was  $\pm 1''.3$ .

The determinations of time, of latitude, and in part of azimuth, were effected with a transit instrument of  $1\frac{3}{4}$  inch aperture and 21 inches focal length. The observations for time and azimuth were combined by erecting marks in or near the meridian: at Trunz one *M* just north, a second *A*,  $2^\circ 20'$  to the west of north, and a third *B* as much to the east. This angle being a little less than the greatest azimuth of the pole star, the vertical plane passing through either mark cuts the path of the star in two points, so that

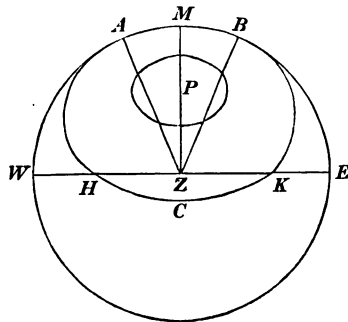

Fig. 5.

if the transit instrument be so placed that its centre thread bisects one of the marks, then two transits of the pole star can be observed, one just before, the other just after the time of its greatest azimuth. These, combined with transits of quick-moving stars near the zenith, determine both azimuth and time.

Determinations of azimuth were also made with the larger theodolite by observing the angle between a terrestrial mark and the pole star, the instant of observing the star being noted. A single determination of the angle involved the following operations:—the reading of the transverse level of the theodolite in reversed positions, the observation of the mark, the star; the star, the mark, the level again. Before the next following measure of the angle, the telescope was reversed so as to change the sign of the collimation error.

In the preceding diagram  $MZC$  is the meridian,  $WZE$  the prime vertical,  $KCH$  the diurnal path of a star whose declination is less than the latitude of the place of observation; such a star crosses the prime vertical first on the east side of the zenith and again on the west. Now if, by means of a transit instrument, adjusted so that its collimation line describes the plane  $WZE$ , we observe the times of the eastern and western transits, half the interval gives the angle  $ZPK$ , whence, knowing  $PK$ , the star's North Polar distance, one can easily calculate  $PZ$  the required colatitude. Or if the precise time of one transit only be known, that is sufficient for a determination. By this method the latitudes of Trunz, Memel, and Königsberg were determined; the observations extending over ten days at Trunz and thirteen at Memel. The reduction of all these astronomical observations—a somewhat serious calculation—was effected by means of formulæ remarkable for their elegance. No loophole was left for any residual error to arise from defect of calculation.

The reduction of the horizontal angles and calculation of the triangulation were effected by the method of least squares—a very laborious process—culminating in the solution of 31 equations containing 31 unknown quantities. If in effecting a triangulation one observed only just so many angles as were absolutely necessary to fix all the points, there would be

no difficulty in calculating the work; only one result could be arrived at. But it is the invariable custom to observe more angles than are absolutely needed, and it is these supernumerary angles which give rise to complex calculations. Until the time of Gauss and Bessel computers had simply used their judgment as they best could as to how to employ and utilize the supernumerary angles; the principle of least squares showed that a system of corrections ought to be applied, one to each observed bearing or angle, such that subject to the condition of harmonizing the whole work, the sum of their squares should be an absolute minimum. The first grand development of this principle is contained in this work of Bessel's.

In 1823 Colonel Everest was appointed to succeed Colonel Lambton in the direction of the Great Trigonometrical Survey of India. The latter had measured an arc of meridian, ten degrees in length, from Punnoe, near Cape Comorin, to Damargida, in latitude  $18^{\circ} 3'$ , and the continuation of the arc northward fell to Colonel Everest. The instruments which had been used by Colonel Lambton were two steel chains, a zenith sector by Ramsden, a theodolite of 18 inches, and another of 36 inches diameter. This last in 1808 met with a serious accident while being raised to the top of a pagoda, having, through the snapping of a rope, been dashed against the wall. The distorted circle was by the help of native artificers brought back to something like its original form, and with this instrument Colonel Everest measured—certainly with much skill—his angles. The account of the measurement of the arc between Damargida and Kalianpur is to be found in a volume by Colonel Everest, entitled *An Account of the Measurement of an Arc of the Meridian between the parallels of  $18^{\circ} 3'$  and  $24^{\circ} 7'$  . . .* (London, 1830). The length of the arc depended on three base lines, one at either extremity, and the third at Takal Khera, near the centre. The astronomical station Takal Khera divides the arc into two very nearly equal parts, the amplitudes of the northern and southern sections being

$$a' = 3^{\circ} 1' 19''.91,$$

$$a = 3^{\circ} 2' 35''.86.$$

On comparing these with the corresponding terrestrial lengths



(in feet) it appears that if  $\rho'$   $\rho$  be the radii of curvature of the meridian at the middle points of the two sections

$$\begin{aligned}\rho' &= 20803380, & \text{in latitude } \phi' &= 22^\circ 36' 32''; \\ \rho &= 20813200, & \text{in latitude } \phi &= 19^\circ 34' 34''.\end{aligned}$$

Here we have an anomaly that has been met with in other places, namely, that the curvature of the meridian apparently increases towards the north. Such an effect might result from an error of latitude of the centre point of the arc, and Colonel Everest looked for the possible source of the error in the attraction of a mass of mountains or table-land to the north of Takal Khera, called the Mahadeo P'har. This table-land approaches in form to a rectangle of length  $AB=120$  miles, breadth  $BD=60$  miles, Takal Khera

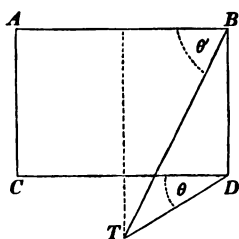

Fig. 6.

$T$  being distant 20 miles from and opposite to the middle point of  $CD$ . The mean height of the range above  $T$  is about 1600 feet or 0.3 mile. Colonel Everest, to obtain the deflection of the direction of gravity at  $T$ , caused by the attraction of this mass, investigates a general expression for the attraction of a parallelopiped at any external point. We may verify his result by a simple formula which will be found in chapter XII of this volume. The deflection at  $T$  depends on the angles  $\theta$   $\theta'$ , as marked in the diagram, and is expressed by the formula

$$\delta = 12''.44 g h \log_e (\tan \frac{1}{2} \theta' \cot \frac{1}{2} \theta),$$

where  $g$  is the ratio of the density of the hills to the mean density of the earth ( $g=0.6$ ) and  $h$  the height of the plateau in miles ( $h=0.3$ ). Thus, using common logarithms,

$$\delta = 10''.31 \log (\tan \frac{1}{2} \theta' \cot \frac{1}{2} \theta).$$

Now  $\theta' = 53^\circ 8'$  and  $\theta = 18^\circ 26'$ , and we have

$$\log \tan 26^\circ 34' \dots 9.6990,$$

$$\log \cot 9^\circ 13' \dots 0.7898,$$

$$\log \tan \frac{1}{2} \theta' \cot \frac{1}{2} \theta \dots 0.4888,$$

which multiplied by  $10''.3$  gives  $5''.0$  as the required error of latitude. Colonel Everest then investigates the alteration

required to the latitude of Takal Khera in order that the two sections of the arc may conform to the (then) received value of the earth's ellipticity, namely,  $\frac{1}{298}$ . We may verify his result by an approximate calculation. A correction  $x$  to the latitude of Takal Khera makes the amplitudes  $a' - x$  and  $a + x$ , and the radii of curvature become

$$\rho' \left(1 + \frac{x}{a'}\right); \quad \rho \left(1 - \frac{x}{a}\right)$$

which are to be equated respectively to

$$A - 3B \cos 2\phi'; \quad A - 3B \cos 2\phi,$$

$A$  and  $B$  being the half sum and half difference of the semi-axes of the earth, and  $A = 600 B$ . Then eliminating  $A$ , we have with close approximation

$$\frac{x}{a} = \frac{\rho - \rho'}{\rho + \rho'} + \frac{\sin(\phi' - \phi) \sin(\phi' + \phi)}{200},$$

$\rho - \rho' \dots 3.99300,$	$\sin(\phi' - \phi) \dots 8.72359,$
$\rho + \rho' \dots 7.61927,$	$\sin(\phi' + \phi) \dots 9.82691,$
$\cdot 000236 \dots 6.37373,$	$\cdot 005 \dots 7.69897,$
$\cdot 000178 \dots \dots \dots$	$\dots 6.24947,$
$\cdot 000414 = x : a.$	

Thus  $a$  being  $10956''$ ,  $x = 4''.5$ . This agreement with the computed error, as caused by the attraction of the Mahadeo mountains, is very satisfactory.

The accident to the great theodolite had the effect of turning Colonel Everest's attention to the necessity of measuring every angle on different parts of the circle, the zero being shifted systematically through equal spaces—a practice very rigidly adhered to on the Survey ever after. Nevertheless he was not satisfied with his arc between Damargida and Kalianpur: the errors in the sums of the angles of the triangles frequently amounting to  $4''$  and  $5''$ . Accordingly, a few years after, the old theodolite was entirely re-made, a new one of the same size obtained, Ramsden's zenith-sector was replaced by two vertical circles of 36 inches diameter, and for base-line measures, Colby's Compensation-apparatus was obtained. Thus armed with the finest instruments, he revised entirely the arc in question and extended it northward to

Banog in latitude  $30^{\circ} 29'$ . Here however the influence of the Himalayas on the latitude and also on the azimuth are very perceptible, and Kaliana, in latitude  $29^{\circ} 30' 49''$ , was adopted as the northern terminus of the arc. Base lines were measured at Damargida, Kalianpur, and Dehra Dun, near the northern extremity. The comparison of the measured lengths of the terminal bases with their lengths, as computed from the base at Kalianpur, stands thus

	DEHRA DUN.	DAMARGIDA.
Measured length in feet	39183.87.	41578.54.
Computed „ „	39183.27.	41578.18.

Great improvements were also effected by Colonel Everest in the determination of azimuth by the increased number and systematic arrangement of the observations of circumpolar stars. Take for instance the following results of his own observations for azimuth of the 'referring lamp' at Kalianpur in 1836.

By 130 observations of $\delta$ Urs. Min. ...	$179^{\circ} 59' 53''$ .120,
115 „ „ 4 Urs. Min. Bode ...	53.565,
128 „ „ 51 Cephei ...	53.420.

But for the details concerning this arc, reference must be made to the work entitled *An Account of the Measurement of two Sections of the Meridional Arc of India . . .*, by Lieut.-Colonel Everest, F.R.S., etc. (1847). The subsequent history of the Great Trigonometrical Survey of India is to be found in the volumes now being published by Major-General Walker, C.B., F.R.S. Vol. i describes the measurements of the ten base lines; vol. ii treats of the reduction of the triangulation by least squares. At page 137, vol. ii, is a comparison of the observed azimuth at Kalianpur with the observed azimuths at sixty-three different stations in India, exclusive of those under the influence of the Himalaya and Súlimáni mountains. At thirty-four stations the discrepancy of azimuth is under  $3''$ , the largest discrepancy being one of  $10''$ . The conclusion on the evidence of all these meridional determinations is that the observed azimuth at Kalianpur requires a correction of  $1''$ .10. The position of Kalianpur is at *c* in the adjoining diagram, which indicates by simple lines the various chains forming the

Principal Triangulation of India. Some of these are chains of single triangles, others are double chains or strings of quadrilaterals and polygons. The letters *abcdefghijklmnop* indicate the positions of the base lines.

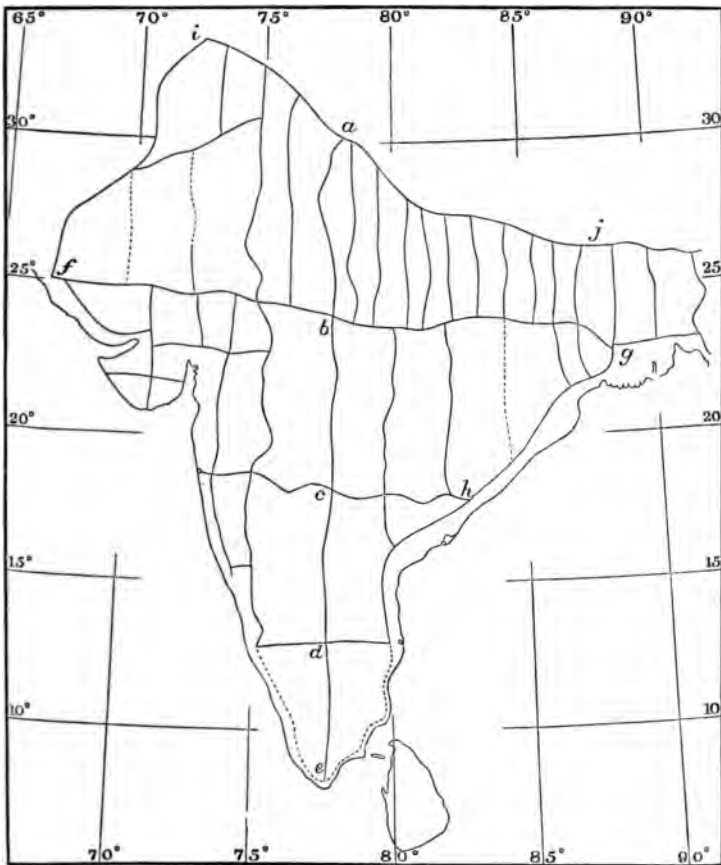

Fig 7.

Sir A. Waugh, who succeeded Sir George Everest, relaxing none of the precision introduced by his predecessor, extended (1843-61) the triangulation by about 7900 miles of chain, mostly double, with determinations of azimuth at 97 stations. Major-General Walker succeeding, added (1861-73) some 5500 miles of triangle chains, mostly double, with

determinations of azimuth at 55 stations and of latitude at 89. This work includes the entire re-measurement of Col. Lambton's arc from Cape Comorin to Damargida. The data of the Indian arc as hitherto used for the problem of the figure of the earth are superseded by these revised and extended triangulations. The following table contains the latitudes of certain points and the distances of their parallels expressed in terms of the standard foot of England. The points marked with an asterisk are on the meridian of  $75^\circ$ , the others are in the line of the original arc<sup>1</sup>.

STATIONS.	LATITUDES.			DISTANCE OF PARALLELS.
	°	'	"	
Shahpur* ... ..	32	1	34.06	8653153.1
Khimnana* ... ..	30	22	11.78	8051100.7
Kaliana... ..	29	30	48.32	7739965.6
Garinda* . . . . .	27	55	30.02	7161851.5
Khamor* ... ..	25	45	10.93	6372728.8
Kalianpur ... ..	24	7	10.79	5778810.6
Fikri* ... ..	22	1	3.77	5014982.1
Walwari* ... ..	20	44	21.27	4551346.4
Damargida ... ..	18	3	14.82	3575896.1
Darur (5) ... ..	16	9	46.13	2889541.2
Honur (5) ... ..	14	55	21.51	2438531.8
Bangalore (3) ... ..	12	59	51.79	1740522.1
Patchapaliam (3) ...	10	59	41.06	1013112.4
Kudankulam (6) ...	8	12	10.44	.....

Each of the last five stations is one of a close group of several astronomical stations. The object of observing latitudes in this manner is the elimination of any purely local attraction; thus, if  $A, B, C, D, E$ , be five stations in a group,  $C$  being the central station, the observed latitudes of  $A, B, D, E$ , are trans-

<sup>1</sup> General Walker has kindly supplied me with these results, not yet published. They are not absolutely final, as the method of least squares has as yet only been extended over the space  $jaifbchg$  in the diagram including the boundary of that space: but it is not likely that any very material alteration will take place in the distances as written above. I have not indeed made use of all the data sent me, which include some 84 stations. The distances in the table are calculated from General Walker's Geodetic Latitudes: they are necessarily dependent to a slight degree on the elements adopted for the figure of the earth, viz. to the amount shown by the expression for  $\delta S$  in Chapter X.

ferred (by means of the triangulation connection) to *C*. Thus we have five astronomical latitudes for *C*, and the mean of the five is adopted as the final result for latitude, being freed to some extent from any effects of local attraction. The number of points in each group is indicated in the table by the number following the name of the station.

The average length of the triangle sides is about thirty miles, very few amounting to sixty. In order to carry his triangles with tolerably long sides over the plains, Sir George Everest built masonry towers of 50 feet and upwards in height for his stations; this height, however, together with the length of the triangle sides, was subsequently reduced. After many changes in the construction of the towers it was found that, on account of a liability to settlement, a hollow tower is best, allowing the theodolite to be accurately centred over the centre-mark of the station below.

To secure the permanence of the principal triangulation stations they are placed under the protection of the local native officials, are inspected from time to time, and are annually reported on and kept in repair. For observation, luminous signals—argand lamps by night and heliotropes by day—are exclusively used in India, the effective light aperture being regulated by the distance of the observing theodolite.

The work entitled *Account of the Observations and Calculations of the Principal Triangulation*<sup>1</sup> . . . , by Captain A. R. Clarke, R.E., London, 1858, describes the geodetic operations commenced in this country by General Roy, prosecuted from 1809 to 1846 by Colonel Colby, R.E., and completed during the directorship of General Sir H. James. The triangulation is not arranged, as in India, in chains, but covers the country with a general network, extending from Scilly to Shetland. A peculiar feature of this work is that the great mass of the observations, terrestrial and astronomical, have been made by non-commissioned officers of the Royal Engineers<sup>2</sup>.

<sup>1</sup> Ordnance Trigonometrical Survey of Great Britain and Ireland.

<sup>2</sup> Pre-eminent among them, Sergeant James Steel (subsequently Quarter-Master R.E. and Captain), a native of Wishaw, Lanarkshire. He enlisted as a miner, made himself a proficient in mathematics and astronomy, and,

In 1862 the triangulation was extended through the north of France into Belgium, and from these measurements the distance of the parallels of Greenwich and Dunkirk was found to be 161407.5 standard feet. Thus there is a well connected triangulation extending from Formentera to Shetland, affording for the problem of the figure of the earth the following data :

STATIONS.	LATITUDES.			DISTANCE OF PARALLELS.
	°	'	"	
Saxavord <sup>1</sup> ... ..	60	49	37.21	8086820.7
North Rona ... ..	59	7	15.19	7463029.3
Great Stirling ... ..	57	27	49.12	6857323.3
Kellie Law ... ..	56	14	53.60	6413221.7
Durham ... ..	54	46	6.20	5872637.9
Clifton ... ..	53	27	29.50	5394063.4
Arbury ... ..	52	13	26.59	4943837.6
Greenwich ... ..	51	28	38.30	4671198.3
Dunkirk <sup>1</sup> ... ..	51	2	8.41	4509790.8
Dunnose ... ..	50	37	6.54	4357480.7
Pantheon <sup>1</sup> ... ..	48	50	47.98	3710827.1
Carcassonne ... ..	43	12	54.30	1657287.9
Barcelona ... ..	41	22	47.90	988701.9
Montjoux ... ..	41	21	44.96	982671.0
Formentera ... ..	38	39	53.17	.....

The great Russian arc of 25° 20' is described by the celebrated astronomer, F. G. W. Struve, in two volumes, entitled *Arc du Méridien de 25° 20' entre le Danube et la mer glaciale mesuré depuis 1816, jusqu'en 1855 . . . . . ouvrage composé sur les différents matériaux et rédigé, par F. G. W. Struve. St. Pétersbourg, 1860.* The chain is composed of some 258 triangles, exclusive of those required for the junction of the 10 base-lines ; the number of astronomical stations at which

attaining singular skill as an observer, was entrusted with the more delicate parts of our geodetic survey—such as the measurement of the Salisbury Plain Base with the Compensation apparatus—the field operations connected with the determination of the density of the earth at Arthur's Seat, &c.

<sup>1</sup> For the latitudes of these stations see the remarks, page 282, of the volume entitled *Comparisons of the Standards of Length of England, France, Belgium, Prussia, Russia, &c., made at Southampton.* By Captain Clarke, R. E.

the latitude and direction of the meridian were determined is thirteen. The arc may be divided into seven sections, thus :

DISTRICT.	BETWEEN LATITUDES.	MEASURED UNDER DIRECTION OF	IN THE YEARS
Bessarabia ... ..	45 20 & 48 45	General de Tenner	1844-52
Podolia and Volhynia	48 45 " 52 3	General de Tenner	1835-40
Lithuania ... ..	52 3 " 56 30	General de Tenner	1816-28
Baltic Provinces ...	56 30 " 60 5	F. G. W. Struve...	1816-31
Finland ... ..	60 5 " 65 50	F. G. W. Struve...	1830-51
Lapland ... ..	65 50 " 68 54	M. Selander ...	1845-52
Finmark ... ..	68 54 " 70 40	M. Hansteen ...	1845-50

In the southern part of the arc for a space of 8°, from the Duna to the Dneister, a flat and marshy country covered with immense and almost impenetrable forests, presented great obstacles to the prosecution of the work, a difficulty overcome by General de Tenner by the erection of a great number of scaffoldings of 120 and even as much as 146 feet high. Struve's work should be studied by all who are interested in geodesy.

The final results of the arc, after reducing Struve's distances to English feet, are contained in the following table :—

STATIONS.	LATITUDES.	DISTANCE OF PARALLELS.
Fuglenaes ... ..	70 40 11.23	9257921.1
Stuor-oivi ... ..	68 40 58.40	8530517.9
Tornea ... ..	65 49 44.57	7486789.9
Kilpi-maki ... ..	62 38 5.25	6317905.7
Hogland ... ..	60 5 9.84	5386135.4
Dorpat ... ..	58 22 47.56	4762421.4
Jacobstadt ... ..	56 30 4.97	4076412.3
Nemesch ... ..	54 39 4.16	3400312.6
Belin ... ..	52 2 42.16	2448745.2
Kremenetz ... ..	50 5 49.95	1737551.5
Ssuprunkowzi ... ..	48 45 3.04	1246762.2
Wodolui ... ..	47 1 24.98	616529.8
Staro Nekrassowka ...	45 20 2.94	.....



The arc measured at the Cape of Good Hope<sup>1</sup> by Sir Thomas Maclear, presents the following data :—

STATIONS.	LATITUDES.	DISTANCE OF PARALLELS.
Cape Point ... ..	° ' " 34 21 6.26	1678375.7
Zwart Kop ... ..	34 13 32.13	1632583.3
Royal Observatory ...	33 56 3.20	1526386.8
Heerenlogement Berg	31 58 9.11	811507.7
North End ... ..	29 44 17.66	.....

For an account of the triangulations completed or in course of completion in Denmark, Spain, Italy, and other countries of Europe, reference must be made to the *Verhandlungen der permanenten Commission der Europäischen Gradmessung*,—the yearly reports of the International Geodesic Association.

Determinations of differences of longitude by the electro-telegraphic method have in the last few years attained a high degree of precision, and have been extensively carried out in Europe, America, and India; the Indian determinations contributing largely to our knowledge of the figure of the earth. In Algiers an arc of parallel is being completed by M. le Commandant Perrier; and the details of a European arc of parallel from the West of Ireland to Orsk in Russia may be soon expected.

The probable error of an observed difference of longitude by the electro-telegraphic method may be about  $\pm 0^{\circ}.025$ .

<sup>1</sup> *Verification and Extension of Lacaille's Arc of Meridian at the Cape of Good Hope.* By Sir Thomas Maclear. London, 1866.

## CHAPTER II.

### SPHERICAL TRIGONOMETRY.

#### I.

IN trigonometrical calculations an angle is not limited as in Euclid to two right angles. If a straight line  $OP$  passing through the intersection of the rectangular coordinate axes  $X'OX$ ,  $Y'OY$  make an angle  $\alpha$  with  $OX$ , then as  $OP$  revolves round  $O$  in the direction  $X$  to  $Y$ , starting from the position  $OX$ ;  $\alpha$ , initially zero, becomes in succession  $\frac{1}{2}\pi$ ,  $\pi$ ,  $\frac{3}{2}\pi$ ,  $2\pi$ ,  $\dots$ . Or if the rotation be in the opposite direction, the angles increase negatively. A finite straight

line as  $BC$  is determined completely by its length and direction, and the coordinates of one of its extremities. But with respect to direction, it is frequently necessary to discriminate between the directions  $BC$  and  $CB$ , which differ by  $180^\circ$ . If  $\alpha$  be the angle made by  $BC$  with  $OX$ , and the length of  $BC$  be  $a$ , then the projection of  $BC$  on  $OX$  is  $a \cos \alpha$ , and

the projection of  $CB$  is  $-a \cos \alpha$ . From  $C$ , let there be drawn the line  $CA = b$ , making an angle  $\beta$  with  $OX$ , then the projection of  $BC + CA$  is  $a \cos \alpha + b \cos \beta$ ; then, if also  $AB = c$ , and its direction be  $\gamma$ , its projection is  $c \cos \gamma$ , so that the projection of  $BA$  is  $-c \cos \gamma$ , and this is equal to

$$a \cos \alpha + b \cos \beta.$$

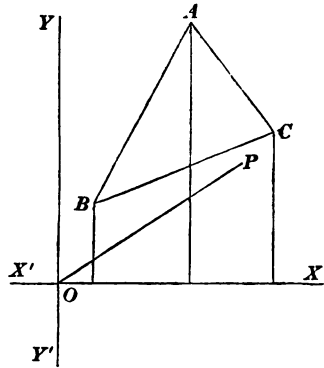

Fig. 8.

Hence

$$a \cos \alpha + b \cos \beta + c \cos \gamma = 0.$$

In a similar manner projecting the three sides of the triangle on  $OY$ ,

$$a \sin \alpha + b \sin \beta + c \sin \gamma = 0.$$

The angles of the triangle being

$$\begin{aligned} A &= 180^\circ + \beta - \gamma, \\ B &= -180^\circ + \gamma - \alpha, \\ C &= 180^\circ + \alpha - \beta; \end{aligned}$$

if from the two previous equations we eliminate first  $c$  and then  $\gamma$ , we get

$$\begin{aligned} b \sin A &= a \sin B, \\ a^2 - 2ab \cos C + b^2 &= c^2, \end{aligned} \quad (1)$$

which are the fundamental equations of plane trigonometry, and contain implicitly the solution of all plane triangles. The second equation really contains the whole, as the first can be easily made to follow from it.

We may also deduce the following equations which we shall find useful hereafter

$$\begin{aligned} a \cos A \cos 2\alpha + b \cos B \cos 2\beta + c \cos C \cos 2\gamma &= 0, \\ a \cos A \sin 2\alpha + b \cos B \sin 2\beta + c \cos C \sin 2\gamma &= 0; \\ b^2 \cos 2\beta + 2bc \cos(\beta + \gamma) + c^2 \cos 2\gamma &= a^2 \cos 2\alpha, \\ b^2 \sin 2\beta + 2bc \sin(\beta + \gamma) + c^2 \sin 2\gamma &= a^2 \sin 2\alpha, \end{aligned} \quad (2)$$

and so on.

Let  $PP_1 = s_1$ ,  $P_1P_2 = s_2$ ,  $P_2P_3 = s_3 \dots$  be the successive sides of a plane polygon  $PP_1P_2 \dots$  making angles  $\alpha_1 \alpha_2 \alpha_3, \dots$  with a line  $PX$  through  $P$ . If  $P'_n$  be the projection of  $P_n$  on  $PX$ , let  $PP'_n = \xi_n$ ,  $P_nP'_n = \eta_n$ : let also the external and internal angles of the polygon at  $P_n$  be  $\pi + \sigma_n$  and  $\pi - \sigma_n$ , so that  $\alpha_n = \alpha_1 - \sigma_1 - \sigma_2 \dots - \sigma_{n-1}$ . Then if

$$\begin{aligned} p_i &= s_i \sin \alpha_i \text{ and } q_i = s_i \cos \alpha_i, \\ \xi_n &= q_1 + q_2 + \dots + q_n, \quad \eta_n = p_1 + p_2 + \dots + p_n, \end{aligned}$$

are the coordinates of  $P_n$ . Let each side and angle receive an increment, then the alterations of  $\xi$ ,  $\eta$  are

$$\begin{aligned} d\xi_n &= q_1 \frac{ds_1}{s_1} + q_2 \frac{ds_2}{s_2} + q_3 \frac{ds_3}{s_3} \dots - p_1 d\alpha_1 - p_2 d\alpha_2 \dots - p_n d\alpha_n, \\ d\eta_n &= p_1 \frac{ds_1}{s_1} + p_2 \frac{ds_2}{s_2} + p_3 \frac{ds_3}{s_3} \dots + q_1 d\alpha_1 + q_2 d\alpha_2 \dots + q_n d\alpha_n. \end{aligned}$$

Now put  $\frac{ds_n}{s_n} - \frac{ds_{n-1}}{s_{n-1}} = dS_{n-1}$ ; then

$$\begin{aligned} \frac{ds_1}{s_1} &= dS, & da_1 &= d\alpha_1, \\ \frac{ds_2}{s_2} &= dS + dS_1, & da_2 &= d\alpha_1 - d\sigma_1, \\ \frac{ds_3}{s_3} &= dS + dS_1 + dS_2, & da_3 &= d\alpha_1 - d\sigma_1 - d\sigma_2, \end{aligned}$$

and so on. Then if  $P_i$  be the last point of the polygon (in fact  $P$ ), the variations of its coordinates as calculated through all the sides and angles are these

$$\begin{aligned} -d\xi_i &= \xi_1 dS_1 + \xi_2 dS_2 + \dots + \xi_{i-1} dS_{i-1} + \eta_1 d\sigma_1 & (3) \\ & \qquad \qquad \qquad + \eta_2 d\sigma_2 \dots + \eta_{i-1} d\sigma_{i-1}, \\ -d\eta_i &= \eta_1 dS_1 + \eta_2 dS_2 + \dots + \eta_{i-1} dS_{i-1} - \xi_1 d\sigma_1 \\ & \qquad \qquad \qquad - \xi_2 d\sigma_2 \dots - \xi_{i-1} d\sigma_{i-1}. \end{aligned}$$

2.

The fundamental equations of spherical trigonometry may be most readily obtained in the following manner. Join  $O$ , the centre of the sphere, with the angular points  $ABC$  of the spherical triangle: let  $Q, R$  be the projections of  $C$  on  $AO$  and  $OB$ ,  $P$  its projection on the plane  $AOB$ ,  $S$  the projection of  $Q$  on  $OB$ . Then

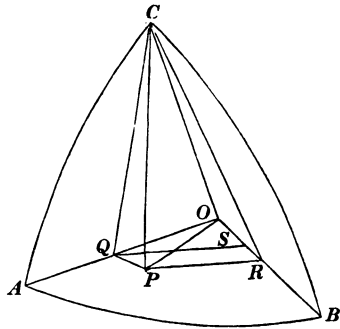

Fig. 9.

$$\begin{aligned} OR &= OS + PQ \sin c, \\ PR &= QS - PQ \cos c, \\ QC \sin A &= RC \sin B; \end{aligned}$$

either member of the last equation being the perpendicular  $CP$ .

Here make the following substitutions:—

$$\begin{aligned} OR &= \cos a, & OS &= \cos b \cos c, \\ CR &= \sin a, & PQ &= \sin b \cos A, \\ OQ &= \cos b, & PR &= \sin a \cos B, \\ CP &= \sin b, & QS &= \cos b \sin c; \end{aligned}$$

and we have immediately the first three of the following set

of equations. Moreover, if  $B$  be projected on the plane  $AOC$ , we get the additional fourth and fifth

$$\begin{aligned} \cos a &= \cos b \cos c + \sin b \sin c \cos A, \\ \sin a \cos B &= \cos b \sin c - \sin b \cos c \cos A, \\ \sin a \sin B &= \sin b \sin A, \\ \sin a \cos C &= \sin b \cos c - \cos b \sin c \cos A, \\ \sin a \sin C &= \sin c \sin A. \end{aligned} \quad (4)$$

These are not independent, for if we add the sum of the squares of the first three we are led to an identical equation—so also by adding the squares of the first, fourth, and fifth. They are therefore equivalent to only three equations, so that if  $b, c$  and the included angle  $A$  are given, we obtain  $a, B$ , and  $C$  with two checks. But the first equation of the group may be shown to contain the whole; for, from it the values of  $1 \pm \cos A$ , and put

$$\begin{aligned} a + b + c &= 2\sigma, \\ -a + b + c &= 2\sigma_1, \\ a - b + c &= 2\sigma_2, \\ a + b - c &= 2\sigma_3; \end{aligned}$$

then at once

$$\begin{aligned} \sin \frac{1}{2} A &= \left( \frac{\sin \sigma_2 \sin \sigma_3}{\sin b \sin c} \right)^{\frac{1}{2}}, \\ \cos \frac{1}{2} A &= \left( \frac{\sin \sigma \sin \sigma_1}{\sin b \sin c} \right)^{\frac{1}{2}}; \end{aligned}$$

multiply these together and we see that

$$\frac{\sin A}{\sin a} = \frac{\sin B}{\sin b} = \frac{\sin C}{\sin c},$$

which contain the third and fifth equation of group (4); and the second and fourth follow.

### 3.

From the expressions, just written down for the sine and cosine of  $\frac{1}{2} A$ , those of the other angles follow. We may find from them at once the following expressions for the sines and cosines of the half sums and half differences of  $B$  and  $C$ :—

$$\frac{\sin \frac{1}{2} (B + C)}{\cos \frac{1}{2} A} = \frac{\cos \frac{1}{2} (b - c)}{\cos \frac{1}{2} a}, \quad (5)$$

$$\begin{aligned} \frac{\cos \frac{1}{2}(B+C)}{\sin \frac{1}{2}A} &= \frac{\cos \frac{1}{2}(b+c)}{\cos \frac{1}{2}a}, \\ \frac{\sin \frac{1}{2}(B-C)}{\cos \frac{1}{2}A} &= \frac{\sin \frac{1}{2}(b-c)}{\sin \frac{1}{2}a}, \\ \frac{\cos \frac{1}{2}(B-C)}{\sin \frac{1}{2}A} &= \frac{\sin \frac{1}{2}(b+c)}{\sin \frac{1}{2}a}. \end{aligned}$$

These important formulae, which were first given by Delambre, are generally known as Gauss's Theorems: from them, by inter-divisions, the well known Napier's analogies follow.

If  $\Delta$  be the spherical excess or area of the triangle, so that

$$\Delta = A+B+C-\pi,$$

$$\sin \frac{1}{2} \Delta = \sin \frac{1}{2}(B+C) \sin \frac{1}{2}A - \cos \frac{1}{2}(B+C) \cos \frac{1}{2}A.$$

Take half the difference of the first two equations of the last group, and we get

$$\sin \frac{1}{2} \Delta = \frac{\sin \frac{1}{2}b \sin \frac{1}{2}c}{\cos \frac{1}{2}a} \sin A, \tag{6}$$

or putting for  $\sin A$  its equivalent  $2 \sin \frac{1}{2}A \cos \frac{1}{2}A$ ,

$$\sin \frac{1}{2} \Delta = \frac{(\sin \sigma \sin \sigma_1 \sin \sigma_2 \sin \sigma_3)^{\frac{1}{2}}}{2 \cos \frac{1}{2}a \cos \frac{1}{2}b \cos \frac{1}{2}c}. \tag{7}$$

4.

Let  $F$  be any point in the side  $AB$  of a spherical triangle, join  $CF$ , and let this divide the angle  $C$  into segments  $C_1, C_2$ , the corresponding segments of  $AB$  being  $AF = c_1, FB = c_2$ . Then putting  $CF = f$ , the cosine of  $AFC$  is represented by either side of the equation

$$\begin{aligned} &\frac{-\cos a + \cos c_2 \cos f}{\sin c_2 \sin f} \\ &= \frac{\cos b - \cos c_1 \cos f}{\sin c_1 \sin f}, \end{aligned}$$

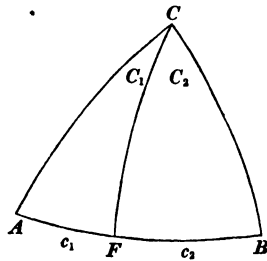

Fig. 10.

which gives

$$\cos f = \cos a \frac{\sin c_1}{\sin c} + \cos b \frac{\sin c_2}{\sin c}. \tag{8}$$

Divide both sides of this by  $\sin f$  and then multiply numerator and denominator of the right-hand side by  $\sin F$ , thus

$$\cot f = \frac{\cos a \sin c_1 \sin F + \cos b \sin c_2 \sin F}{\sin c \sin f \sin F},$$

but

$$\begin{aligned}\sin c_1 \sin F &= \sin b \sin C_1, \\ \sin c_2 \sin F &= \sin a \sin C_2, \\ \sin f \sin c \sin F &= \sin a \sin b \sin C;\end{aligned}$$

and by the substitution of these it follows that

$$\cot f = \cot a \frac{\sin C_1}{\sin C} + \cot b \frac{\sin C_2}{\sin C}. \quad (9)$$

It is frequently necessary to determine the difference of two nearly equal angles from the given difference of their cosines, thus in the equation

$$\cos a - \cos \beta = 2c,$$

$c$  and  $a$  being given,  $\beta$  is to be found. Let  $\beta - a = 2x$ , then  $\sin(a+x) \sin x = c$ , and expanding, we get the bi-quadratic

$$\sin^4 x - (\sin^2 a + 2c \cos a) \sin^2 x + c^2 = 0,$$

of which the required roots are

$$\pm \sin \frac{1}{2}(\beta - a) = \frac{c}{\sin \frac{1}{2} a \cos \frac{1}{2} a} \cdot \left(1 + \frac{c}{\sin^2 \frac{1}{2} a}\right)^{\frac{1}{2}} + \left(1 - \frac{c}{\cos^2 \frac{1}{2} a}\right)^{\frac{1}{2}}. \quad (10)$$

For instance, if in the spherical quadrilateral  $PQpq$  the angles  $P, Q$  are right angles, and the sides  $Pp, Qq$  are equal, say each =  $b$ , then producing these sides to meet in a point  $A$ ,

$$\cos a - \cos A = 2 \sin^2 \frac{a}{2} \tan^2 b,$$

where  $A = PQ$  and  $a = pq$ . Then the formula (10) leads to this—

$$\sin \frac{1}{2}(A - a) = \frac{\sin b \sin \psi}{1 + \cos b \cos \psi},$$

or,  $\tan \frac{1}{4}(A - a) = \tan \frac{1}{2} b \tan \frac{1}{2} \psi,$  (11)

where  $2\psi$  is the spherical excess of the quadrilateral.

5.

Differentiate the first equation of group (4) and in the coefficients of  $db$ ,  $dc$  substitute respectively from the fourth and second equations of the group, then dividing through by  $\sin a$ , the result is the first of the following set of equations; the second and third follow by cyclical interchange of symbols:

$$\begin{aligned} da - \cos Cdb - \cos Bdc &= \sin c \sin Bda, & (12) \\ -\cos Cda + db - \cos Ade &= \sin a \sin CdB, \\ -\cos Bda - \cos Adb + dc &= \sin b \sin AdC. \end{aligned}$$

From these either by elimination or by the use of the polar triangle, we get

$$\begin{aligned} da + \cos cdB + \cos bdC &= \sin B \sin cda, & (13) \\ \cos cdA + dB + \cos adC &= \sin C \sin adb, \\ \cos bdA + \cos adB + dC &= \sin A \sin bdc. \end{aligned}$$

These may be again put in the form

$$\begin{aligned} \sin Bda - \cos c \sin Adb - \sin a \cos Bdc &= \sin cda, & (14) \\ -\cos c \sin Bda + \sin Adb - \sin b \cos AdC &= \sin cdB, \\ \cos Bda + \cos Adb + \sin b \sin AdC &= dc; \end{aligned}$$

and the polar triangle gives

$$\begin{aligned} \sin bdA + \cos C \sin adB + \sin A \cos bdc &= \sin Cda, & (15) \\ \cos C \sin bdA + \sin adB + \sin B \cos adc &= \sin Cdb, \\ -\cos bdA - \cos adB + \sin B \sin adc &= dC. \end{aligned}$$

Suppose, for example, the side  $c$  is constant, and that the angles  $A$ ,  $B$  are liable to errors  $dA$ ,  $dB$ ; then the corresponding errors in the other parts of the triangle will be known by making  $dc = 0$  in the preceding equations: thus

$$\begin{aligned} \sin Cda &= \sin bdA + \cos C \sin adB, \\ \sin Cdb &= \cos C \sin bdA + \sin adB, & (16) \\ dC &= -\cos bdA - \cos adB. \end{aligned}$$

6.

In the case of the right-angled spherical triangle,  $A$  being the right angle, the general formulae become

$$\begin{aligned} \sin a \sin B &= \sin b, & (17) \\ \sin a \cos B &= \cos b \sin c, \\ \cos a &= \cos b \cos c, \\ \sin a \cos C &= \cos c \sin b, \\ \sin a \sin C &= \sin c; \end{aligned}$$



which, as in the general case, are equivalent evidently to three equations.

Suppose the sides  $b$  and  $c$  given, then we get  $\tan B$  and  $\tan C$ . Or more conveniently thus: let  $B = 90^\circ - \mathcal{V}$ , then by Napier's analogies, or equations (5)

$$\tan \frac{1}{2}(B+C) = \frac{1 + \tan \frac{1}{2}(C-\mathcal{V})}{1 - \tan \frac{1}{2}(C-\mathcal{V})} = \frac{\cos \frac{1}{2}(b-c)}{\cos \frac{1}{2}(b+c)};$$

whence the following

$$\begin{aligned} \tan \frac{1}{2}(C-\mathcal{V}) &= \tan \frac{1}{2}b \tan \frac{1}{2}c, \\ \tan \frac{1}{2}(C+\mathcal{V}) &= \cot \frac{1}{2}b \tan \frac{1}{2}c; \end{aligned} \quad (18)$$

by this method two logarithms are looked out instead of four. From these also, if  $B, C$  be given,  $b$  and  $c$  are easily obtained. Again, if the angle  $B$  and the adjacent side  $c$  be given, then by (5)

$$\begin{aligned} \tan \frac{1}{2}(a+b) &= \tan \frac{1}{2}c \cot \frac{1}{2}\mathcal{V}, \\ \tan \frac{1}{2}(a-b) &= \tan \frac{1}{2}c \tan \frac{1}{2}\mathcal{V}; \end{aligned} \quad (19)$$

where again the factors on the right are only two in number.

Let us now in the right-angled triangle suppose the case of the side  $c$  being small, in which case also are  $C$  and  $\mathcal{V}$  small. We have here from the fourth and fifth of (17)

$$\frac{\tan C}{\tan c} = \frac{1}{\sin b},$$

put for a moment the right hand member of this equation =  $k$ ; then expanding the tangents into series, we have

$$C + \frac{1}{3}C^3 + \frac{1}{15}C^5 + \dots = k(c + \frac{1}{3}c^3 + \frac{1}{15}c^5 + \dots);$$

let  $C = kc + k'c^3 + k''c^5 + \dots$ , then by the method of indeterminate coefficients, we easily arrive at the result

$$\frac{C}{c} = k \left\{ 1 + \frac{c^2}{3}(1-k^2) + \frac{c^4}{15}(1-k^2)(2-3k^2) \dots \right\}. \quad (20)$$

Replacing the value of  $k$ , and bearing in mind that

$$\sin(b+x) = \sin b(1+x \cot b),$$

when the square of  $x$  is neglected, we find

$$C = \frac{c}{\sin(b + \frac{1}{3}c^2 \cot b)},$$

the terms omitted in this approximation are in  $c^5$ . Again, by the second and fifth of (17)

$$\sin \mathcal{V} = \sin C \cos b;$$

$$\therefore V = C \cos b \left(1 - \frac{c^2}{6} - \dots\right),$$

which omitting only terms in  $c^5$  may be put in the form

$$V = C \cos \left(b + \frac{1}{3} c^2 \cot b\right).$$

Again,  $a$  exceeds  $b$  by a small quantity,  $x$  say, then

$$\cos(b+x) = \cos b \cos x,$$

$$\therefore x = \frac{c^2}{2} \cot b - \frac{c^4}{24} (1 + 3 \cot^2 b) \cot b.$$

Supposing then that we may omit the fourth power of  $c$ , the solution of the triangle is this

$$a-b = \frac{c^2}{2} \cot b = \eta, \tag{21}$$

$$C = \frac{c}{\sin \left(b + \frac{2}{3} \eta\right)},$$

$$90^\circ - B = C \cos \left(b + \frac{1}{3} \eta\right).$$

With respect to the error committed in neglecting the part of  $a-b$  which depends on  $c^4$ , suppose  $c$  to be one degree, then if  $b = 30^\circ$ , this term amounts to  $0''\cdot014$ ; if  $b = 45^\circ$  it amounts to  $0''\cdot003$ .

In the more general case in which  $c$  is small, but  $A$  not a right angle, there is a useful application of the series (20). We know from (5) that

$$\frac{\tan \frac{1}{2}(a-b)}{\tan \frac{1}{2}c} = \frac{\sin \frac{1}{2}(A-B)}{\sin \frac{1}{2}(A+B)},$$

and putting for a moment  $k$  for the right hand member of this equation, (20) gives

$$\frac{a-b}{c} = k \left\{ 1 + \frac{c^2}{12} (1-k^2) + \frac{c^4}{240} (1-k^2)(2-3k^2) \dots \right\}.$$

In computing  $a-b$  from this formula,  $k$  and  $c$  being given, the error involved in omitting the term in  $c^5$  is very small; for the greatest numerical value of  $k(1-k^2)(2-3k^2)$  corresponding to the value of  $k$ , satisfying the quadratic equation  $15k^4 - 15k^2 + 2 = 0$ , is  $0\cdot51 \dots$ . If then  $c$  be as much as  $2^\circ$ , the term in  $c^5$  amounts at a maximum to  $0''\cdot000022$ ; it may therefore in all cases be neglected, and we have thus

$$a-b = c \frac{\sin \frac{1}{2}(A-B)}{\sin \frac{1}{2}(A+B)} \left\{ 1 + \frac{c^2}{12} \cdot \frac{\sin A \sin B}{\sin^2 \frac{1}{2}(A+B)} \right\}. \tag{22}$$

Let  $S$  be a point within the given right-angled triangle  $ABC$ , such that  $BS = AB = c$ , and  $ABS = \theta$ : it is required to find the angle  $ACS$ . Let this angle =  $\eta$ , and  $CS = \zeta$ , then

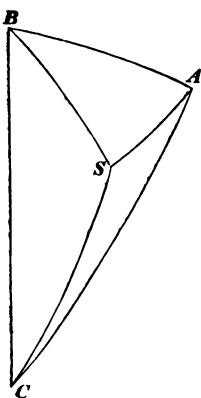

Fig. 11.

$$\begin{aligned} \sin \eta \sin \zeta &= \sin SA \cos SAB \\ &= \sin 2c \sin^2 \frac{1}{2} \theta. \end{aligned}$$

Here replace  $\sin \zeta$  by its equivalent

$$\sin c \frac{\sin(B-\theta)}{\sin(C-\eta)},$$

and we get

$$\begin{aligned} \tan \eta &= \frac{2 \sin^2 \frac{1}{2} \theta \cos c \sin C}{\sin(B-\theta) + 2 \sin^2 \frac{1}{2} \theta \cos c \cos C}, \\ &= \frac{\tan C}{1 + \frac{\sec^2 c \sin(B-\theta)}{2 \sin^2 \frac{1}{2} \theta \sin B}}; \end{aligned}$$

either of these expressions is convenient for the calculation of  $\tan \eta$ . The case applies to the determination of the azimuth of a circumpolar star,  $B$  being the pole of the heavens,  $C$  the zenith, and  $A$  the place of the star  $S$  when at its greatest azimuth. When  $\theta$  is small, then approximately

$$\eta = \frac{2 \sin^2 \frac{1}{2} \theta \cos^2 c \tan C}{1 - \cot B \sin \theta}; \quad (23)$$

of which the error is, very nearly,  $\sin^4 \frac{1}{2} \theta \sin^2 2c \tan C$ .

## 7.

Consider next the case of a spherical triangle all of whose sides are small with respect to the radius of the sphere. Let  $A', B', C'$  be the angles, and  $\Delta'$  the area of a plane triangle whose sides are  $a, b, c$ , the same as those of the spherical triangle; then omitting small quantities of the sixth order, (7) becomes

$$\begin{aligned} \Delta &= \frac{(\sin \sigma \sin \sigma_1 \sin \sigma_2 \sin \sigma_3)^{\frac{1}{2}}}{\cos \frac{1}{2} a \cos \frac{1}{2} b \cos \frac{1}{2} c}, \\ &= (\sigma \sigma_1 \sigma_2 \sigma_3)^{\frac{1}{2}} \left(1 + \frac{a^2 + b^2 + c^2}{24}\right), \\ \Delta &= \Delta' \left(1 + \frac{a^2 + b^2 + c^2}{24}\right). \end{aligned} \quad (24)$$

Now we have

$$\sin \frac{1}{2} A \cos \frac{1}{2} A' = \left( \frac{\sigma \sigma_1}{bc} \right)^{\frac{1}{2}} \left( \frac{\sin \sigma_2 \sin \sigma_3}{\sin b \sin c} \right)^{\frac{1}{2}},$$

$$\cos \frac{1}{2} A \sin \frac{1}{2} A' = \left( \frac{\sigma_2 \sigma_3}{bc} \right)^{\frac{1}{2}} \left( \frac{\sin \sigma \sin \sigma_1}{\sin b \sin c} \right)^{\frac{1}{2}};$$

$$\therefore \sin \frac{1}{2} (A - A') = \frac{\Delta'}{bc} \frac{\left( \frac{\sin \sigma_2 \sin \sigma_3}{\sigma_2 \sigma_3} \right)^{\frac{1}{2}} - \left( \frac{\sin \sigma \sin \sigma_1}{\sigma} \right)^{\frac{1}{2}}}{\left( \frac{\sin b \sin c}{b \cdot c} \right)^{\frac{1}{2}}};$$

and since,  $\sin \frac{1}{2} \sigma = \sigma^{\frac{1}{2}} \left( 1 - \frac{\sigma^2}{12} + \frac{\sigma^4}{1440} \right)$ , and

$$\sigma^2 - \sigma_2^2 + \sigma_1^2 - \sigma_3^2 = 2bc,$$

$$\sigma^4 - \sigma_2^4 + \sigma_1^4 - \sigma_3^4 = bc(3a^2 + b^2 + c^2),$$

$$\sigma_2^2 \sigma_3^2 - \sigma^2 \sigma_1^2 = \frac{1}{2} bc(a^2 - b^2 - c^2),$$

we get

$$A - A' = \frac{1}{3} \Delta' \left( 1 + \frac{a^2 + 7b^2 + 7c^2}{120} \right).$$

Replacing  $\Delta'$  by  $\Delta$  from (24), we get the first of the following equations, the second and third following by symmetry :

$$A = A' + \frac{\Delta}{3} + \frac{\Delta}{180} (-2a^2 + b^2 + c^2), \quad (25)$$

$$B = B' + \frac{\Delta}{3} + \frac{\Delta}{180} (a^2 - 2b^2 + c^2),$$

$$C = C' + \frac{\Delta}{3} + \frac{\Delta}{180} (a^2 + b^2 - 2c^2).$$

If here we omit the terms of the fourth order we have Legendre's Theorem, which is this: the angles  $A, B, C$  of a spherical triangle whose sides are  $a, b, c$ , supposed very small with respect to the radius of the sphere, are equal to the corresponding angles of the plane triangle whose sides are  $a, b, c$ , increased each by one-third of the spherical excess of the triangle.

The use of Legendre's Theorem greatly simplifies the solution of triangles in practical geodesy; it remains to be seen how far it can be used with safety. If  $\epsilon$  be the spherical excess of a triangle, then the side  $c$  being given, we have by Legendre's Theorem

$$a = c \sin \left( A - \frac{1}{3} \epsilon \right) \operatorname{cosec} \left( C - \frac{1}{3} \epsilon \right),$$

$$b = c \sin \left( B - \frac{1}{3} \epsilon \right) \operatorname{cosec} \left( C - \frac{1}{3} \epsilon \right).$$

Let  $\partial a, \partial b$  be the errors of the sides so computed. They will depend on the actually adopted value of  $\epsilon$ , which may be computed in more than one way: we shall therefore first express the errors in terms of an arbitrary  $\epsilon$ , thus<sup>1</sup>

$$\partial a = c \frac{\sin(A - \frac{1}{2}\epsilon)}{\sin(C - \frac{1}{2}\epsilon)} - \sin^{-1} \left( \sin c \frac{\sin A}{\sin C} \right).$$

By the verification of the following steps

$$\cot C - \cot A = \frac{a^2 - c^2}{ab \sin C} \left( 1 + \frac{a^2 - b^2 - c^2}{12} \right),$$

$$c \frac{\sin(A - \frac{1}{2}\epsilon)}{\sin(C - \frac{1}{2}\epsilon)} = c \frac{\sin A}{\sin C} + \frac{a}{6} (a^2 - c^2) \frac{2\epsilon}{ab \sin C},$$

$$\sin^{-1} \left( \sin c \frac{\sin A}{\sin C} \right) = c \frac{\sin A}{\sin C} + \frac{a}{6} (a^2 - c^2) \left( 1 - \frac{a^2}{20} + \frac{7c^2}{60} \right),$$

in the second of which  $\epsilon^2$  is replaced by  $\frac{1}{2} a^2 b^2 \sin^2 C$ , we find

$$\partial a = \frac{a}{6} (a^2 - c^2) \left( \frac{2\epsilon}{ab \sin C} - 1 + \frac{3a^2 - 7c^2}{60} \right).$$

If therefore we calculate  $\epsilon$  by the formula  $2\epsilon = ab \sin C$ , the errors of the resulting sides will be

$$\partial a = \frac{a}{360} (a^2 - c^2) (3a^2 - 7c^2), \quad (26)$$

$$\partial b = \frac{b}{360} (b^2 - c^2) (3b^2 - 7c^2).$$

But if we compute  $\epsilon$  by the formula

$$\sin \frac{\epsilon}{2} = \frac{\sin \frac{1}{2} a \sin \frac{1}{2} b \sin C}{\cos \frac{1}{2} c},$$

or, which amounts to the same thing, by the formula

$$\epsilon = \frac{1}{2} ab \sin C \left( 1 + \frac{3c^2 - a^2 - b^2}{24} \right),$$

the errors are

$$\partial a = \frac{a}{720} (a^2 - c^2) (a^2 - 5b^2 + c^2), \quad (27)$$

$$\partial b = \frac{b}{720} (b^2 - c^2) (b^2 - 5a^2 + c^2).$$

Suppose, for example, to take a numerical case, that the sides of the triangle are  $a = 220$ ,  $b = 180$ ,  $c = 60$  miles,

<sup>1</sup> See *Account of the Principal Triangulation*, page 245.

then by the first method of calculating the spherical excess, the errors of the resulting sides in feet would be

$$\partial a = +0.068, \quad \partial b = +0.026.$$

By the second method the errors would be

$$\partial a = -0.031, \quad \partial b = -0.030.$$

We infer that the errors resulting from the use of Legendre's Theorem are of a minute order, and that they cannot prejudice any applications that can be made of it to actual use.

In the case in which  $a, b,$  and  $C$  are given to find  $A, B,$  and  $c,$  if  $\epsilon = \frac{1}{2} ab \sin C,$  we have

$$\begin{aligned} c \sin \frac{1}{2}(A-B) &= (a-b) \cos \frac{1}{2}(C-\frac{1}{2}\epsilon), & (28) \\ c \cos \frac{1}{2}(A-B) &= (a+b) \sin \frac{1}{2}(C-\frac{1}{2}\epsilon), \\ \frac{1}{2}(A+B) &= 90^\circ - \frac{1}{2}C + \frac{1}{2}\epsilon. \end{aligned}$$

8.

For the determination of the coordinates of points, Legendre's Theorem is applied thus. Let  $P, P_1, P_2, \dots$  be the angular points of a spherical polygon, of which the sides, as well as the angles they contain, are given. Through  $P_1P_2\dots$  draw perpendiculars to the great circle  $PM$  meeting it in  $p_1p_2\dots$ . Take  $q_2$  in  $P_2p_2$ , so that  $p_2q_2 = P_1p_1$ , and join  $P_1q_2$  by an arc of a great circle. Let  $PP_1 = s_1, P_1P_2 = s_2\dots,$  and let the exterior and interior angles at  $P_n$  be  $180 \pm \sigma_n$ ; put also  $\alpha_1, \alpha_2\dots$  for the angles  $P_1Pp_1, P_2P_1q_2\dots$ . Then the angles and spherical excesses of the triangles  $P_1Pp_1, P_2P_1q_2$  being

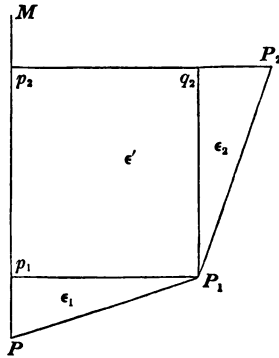

Fig. 12.

$$\begin{aligned} P_1Pp_1: & \alpha_1, & \frac{1}{2}\pi, & \beta_1, & \epsilon_1; \\ P_2P_1q_2: & \alpha_2, & \frac{1}{2}\pi - \frac{1}{2}\epsilon', & \beta_2, & \epsilon_2; \end{aligned}$$

where  $\epsilon'$  is the spherical excess of  $P_1 p_1 p_2 q_2$ , we have

$$\begin{aligned}\beta_1 &= 90^\circ - a_1 + \epsilon_1, \\ a_2 &= a_1 - \sigma_1 - \epsilon_1 - \frac{1}{2} \epsilon', \\ \beta_2 &= \beta_1 + \sigma_1 + \epsilon_2 + \epsilon'.\end{aligned}$$

Further, put

$$\begin{aligned}P p_1 &= x_1, & P_1 q_2 &= x_2', & P p_2 &= x_2, \\ P_1 p_1 &= y_1, & P_2 q_2 &= y_2', & P_2 p_2 &= y_2,\end{aligned}$$

then by Legendre's Theorem, in the triangle  $P_1 P p_1$ ,

$$x_1 = s_1 \frac{\cos(a_1 - \frac{2}{3} \epsilon_1)}{\cos \frac{1}{3} \epsilon_1}, \quad y_1 = s_1 \frac{\sin(a_1 - \frac{1}{3} \epsilon_1)}{\cos \frac{1}{3} \epsilon_1}.$$

Practically, we may neglect the divisor  $\cos \frac{1}{3} \epsilon_1$ , and take

$$x_1 = s_1 \cos(a_1 - \frac{2}{3} \epsilon_1), \quad y_1 = s_1 \sin(a_1 - \frac{1}{3} \epsilon_1). \quad (29)$$

The errors of these expressions, if  $\epsilon_1$  is calculated by the formula  $\epsilon_1 = \frac{1}{2} s_1^2 \sin a_1 \cos a_1$ , are

$$\begin{aligned}\partial y_1 &= \frac{s^5}{360} (22 \sin^2 a_1 - 3) \sin a_1 \cos^2 a_1, \\ \partial x_1 &= \frac{s^5}{90} (1 - 13 \sin^2 a_1) \sin^2 a_1 \cos a_1;\end{aligned}$$

which may always be neglected: that is, for a distance  $s$  of  $3''$  they amount at a maximum to  $0''.0007$  and  $0''.0027$  respectively.

So also in the triangle  $P_2 P_1 q_2$ ,

$$x_2' = s_2 \cos(a_2 - \frac{2}{3} \epsilon_2 - \frac{1}{2} \epsilon'), \quad y_2' = s_2 \sin(a_2 - \frac{1}{3} \epsilon_2);$$

where  $\epsilon' = x_2' y_1$ ; and finally,

$$y_2 = y_1 + y_2', \quad x_2 = x_1 + x_2' + \frac{1}{2} y_1 \epsilon'; \quad (30)$$

the last following from (11).

## 9.

The expansion of  $(1 + 2n \cos \theta + n^2)^{-s}$  is one of importance in geodetical as in other calculations: it is proposed to expand this in a series proceeding by cosines of multiples of  $\theta$ .

Let  $z = \epsilon^{\theta \sqrt{-1}}$ , then  $z + \frac{1}{z} = 2 \cos \theta$ , and  $z^r + \frac{1}{z^r} = 2 \cos r \theta$ ; thus we have

$$\begin{aligned}(1 + 2n \cos \theta + n^2)^{-s} &= (1 + nz)^{-s} \left(1 + \frac{n}{z}\right)^{-s}, \\ &= \left\{1 - snz + \frac{s(s+1)}{2} n^2 z^2 - \dots\right\} \left\{1 - s \frac{n}{z} + \frac{s(s+1)}{2} \frac{n^2}{z^2} - \dots\right\};\end{aligned}$$

which multiplied out becomes

$$\begin{aligned}
 &= 1 + s^2 n^2 + \frac{s^2(s+1)^2}{1 \cdot 2^2} n^4 + \dots \\
 &\quad - \left(z + \frac{1}{z}\right) \left(sn + \frac{s^2(s+1)}{1 \cdot 2} n^3 + \dots\right) \\
 &\quad + \left(z^2 + \frac{1}{z^2}\right) \left(\frac{s(s+1)}{1 \cdot 2} n^2 + \frac{s^2(s+1)(s+2)}{1 \cdot 2 \cdot 3} n^4\right) \\
 &\quad - \left(z^3 + \frac{1}{z^3}\right) \left(\frac{s(s+1)(s+2)}{1 \cdot 2 \cdot 3} n^3 + \dots\right).
 \end{aligned}$$

The term in  $n^4$  is retained, though however it will not be actually required. We are more immediately interested in the cases in which  $s = \frac{1}{2}$  and  $s = \frac{3}{2}$ : they stand thus,

$$(1 + 2n \cos \theta + n^2)^{-\frac{1}{2}} = 1 + \frac{1}{2^2} n^2 + \frac{3^2}{2^6} n^4 + \dots \tag{31}$$

$$\begin{aligned}
 &\quad - \cos \theta \left(n + \frac{3}{2^3} n^3 + \dots\right) \\
 &\quad + \cos 2\theta \left(\frac{3}{2^2} n^2 + \frac{5}{2^4} n^4 + \dots\right) \\
 &\quad - \cos 3\theta \left(\frac{5}{2^3} n^3 + \dots\right); \\
 &\quad \vdots
 \end{aligned}$$

$$(1 + 2n \cos \theta + n^2)^{-\frac{3}{2}} = 1 + \frac{3^2}{2^2} n^2 + \frac{3^2 \cdot 5^2}{2^2 \cdot 4^2} n^4 + \dots \tag{32}$$

$$\begin{aligned}
 &\quad - \cos \theta \left(3n + \frac{3^2 \cdot 5}{2^3} n^3 + \dots\right) \\
 &\quad + \cos 2\theta \left(\frac{3 \cdot 5}{2^2} n^2 + \frac{3 \cdot 5 \cdot 7}{2^4} n^4 + \dots\right) \\
 &\quad - \cos 3\theta \left(\frac{5 \cdot 7}{2^3} n^3 + \dots\right).
 \end{aligned}$$

We have also for the logarithmic expansion,

$$\begin{aligned}
 \log(1 + 2n \cos \theta + n^2) &= \log(1 + nz) + \log\left(1 + \frac{n}{z}\right) \\
 &= M \left\{ n \left(z + \frac{1}{z}\right) - \frac{n^2}{2} \left(z^2 + \frac{1}{z^2}\right) + \frac{n^3}{3} \left(z^3 + \frac{1}{z^3}\right) \dots \right\}, \\
 &= 2M \left\{ n \cos \theta - \frac{n^2}{2} \cos 2\theta + \frac{n^3}{3} \cos 3\theta - \dots \right\}; \tag{33}
 \end{aligned}$$

where  $M$  is the modulus of the common system of logarithms:  $\log M = 9.6377843$ .



## CHAPTER III.

### LEAST SQUARES.

THE method of least squares, foreshadowed by Simpson and D. Bernoulli, was first published by Legendre in 1806. It had however been previously applied by Gauss, who, in his *Theoria Motus, &c.*, 1809, first published the now well-known law of facility of errors, basing the method of least squares on the theory of probabilities. The subject is very thoroughly dealt with by Laplace in his *Théorie analytique des probabilités*: it is full of mathematical difficulties, and we can here give but the briefest outline.

#### I.

The results of a geodetic survey, whether distances between points, or azimuths, or latitudes, are affected by errors which are certain linear functions of errors of observation; thus the precision of the results depends first on the precision of the angular and linear measurements; and secondly, on the manner in which those measurements enter into the results. Consider first the observations of a single angle. In order to avoid constant errors that would arise, for instance, from errors of graduation, and from any peculiarity of light falling on the two signals observed, the observations are repeated on different parts of the circle, and at different hours of the day, and on different days. The expert observer bears in mind that the probable existence of unrecognized sources of constant error renders it useless to repeat the same measurement a large number of times in succession under precisely the same circumstances. With measurements thus carefully made, and in large numbers, it is to be assumed that the arithmetic mean is, if not the true, at any rate the most probable value of

the angle, and the differences between the individual observations and the mean are the apparent errors of observation. Of course the sum of these errors is zero, and positive and negative signs are equally probable; and it is a matter of observation, or fact, that if such errors be arranged in order of magnitude, the smaller errors are more numerous than the larger, and—mistakes excluded—beyond a certain (not well defined) limit, large errors do not occur. This leads to the conception of a possible law of distribution of errors. Suppose the number of observations indefinitely great, the errors being capable of indefinitely small gradations, then it is conceivable that the number,  $y$ , of errors lying between the magnitudes  $x$  and  $x + dx$  may be expressed by a law such as  $y = \phi(x^2) dx$ ; a function which is the same for positive and negative values of  $x$ , and which must rapidly diminish for increasing values of  $x$ . Here  $y$  also expresses the probability of any chance error falling between  $x$  and  $x + dx$ , provided the integral of  $y dx$  between the limits  $\pm \infty$  be made = 1.

The nature of the function  $\phi$  has been investigated from various points of view, each investigation presenting some difficult or questionable points, but all ending in one and the same result. We shall here give the method proposed by Sir John Herschel, though its validity has been questioned. Let a stone be dropped with the intention that it shall strike a mark on the ground; through this mark suppose two straight lines drawn at right angles. Taking these lines as axes of coordinates  $x, y$ , the chance of the stone falling between the distances  $x, x + dx$ , from the axis of  $y$  is  $\phi(x^2) dx$ , and the chance of its falling between the distances  $y, y + dy$  from the axis of  $x$  is  $\phi(y^2) dy$ . Then regarding these as independent events, the chance of the stone falling on the rectangle  $dx dy$  is  $\phi(x^2) \phi(y^2) dx dy$ , or generally  $\phi(x^2) \phi(y^2) d\sigma$  when  $d\sigma$  is an element of area about  $xy$ . But this chance is not dependent on the particular direction of the axes; if then  $x' y'$  be other coordinates having the same origin,

$$\phi(x^2) \phi(y^2) = \phi(x'^2) \phi(y'^2)$$

if  $x^2 + y^2 = x'^2 + y'^2$ ; an equation of which the complete solution is  $\phi(x^2) = C e^{cx^2}$ . Since however  $\phi(x^2)$  diminishes as  $x$  increases,  $c$  must be negative; write therefore  $-1 : c^2$  instead

of  $c$ . Then, since the integral of  $\phi(x^2) dx$  between  $\pm \infty$  is to be unity, and since

$$\int_{-\infty}^{\infty} e^{-\frac{x^2}{c^2}} dx = c\sqrt{\pi}, \quad (1)$$

it follows that  $Cc\sqrt{\pi} = 1$ . Thus the probability of an error between  $x$  and  $x + dx$  is

$$y = \frac{dx}{c\sqrt{\pi}} e^{-\frac{x^2}{c^2}}; \quad (2)$$

and this expresses also the number of errors between  $x$  and  $x + dx$ , the whole number being supposed to be unity.

## 2.

Let  $\mu_1$  be the mean value of all the errors without regard to sign,  $\mu_2$  the mean value of their squares, then

$$\begin{aligned} \mu_1 &= \frac{2}{c\sqrt{\pi}} \int_0^{\infty} e^{-\frac{x^2}{c^2}} x dx = \frac{c}{\sqrt{\pi}}, \quad (3) \\ \mu_2 &= \frac{1}{c\sqrt{\pi}} \int_{-\infty}^{\infty} e^{-\frac{x^2}{c^2}} x^2 dx = \frac{c^2}{2}. \end{aligned}$$

From the intimate relation thus shown between  $c$  and the average magnitudes of the errors, it has been called the modulus<sup>1</sup> of the system; it is large or small according as the observations are of a coarse or a fine kind.

It follows from this that the number of errors whose absolute magnitudes are between 0 and  $t$  is

$$N = \frac{2}{\sqrt{\pi}} \int_0^t e^{-t^2} dt. \quad (4)$$

The values of this important and well-known integral have been tabulated for all values of  $t$ . For instance, the number of errors less than  $\frac{1}{2}c$ ,  $c$ ,  $2c$ , respectively are

$$N_{\frac{1}{2}c} = .520, \quad N_c = .843, \quad N_{2c} = .995.$$

Thus only five errors in a thousand exceed  $2c$ . There is a certain value of  $c$ , call it  $c' = \rho c$ , to which corresponds the value of  $N = \frac{1}{2}$ , so that half the errors are greater and half are less than  $c'$ . This  $c'$  is called the 'probable error,' since the probabilities of an error exceeding it or falling short of it are equal; and the value of  $\rho$  found from the tabulated values of

<sup>1</sup> Airy, *Theory of Errors of Observation*, page 15.

the integral is .477. The integral (4) gives also the number of errors between 0 and  $ic'$ , if  $t = i\rho$ , thus for the successive values of  $i = \frac{1}{2}, 1, 2, 3, 4, 5$ , the values of  $N$  are

$$.264, .500, .823, .957, .993, .999.$$

So that in a thousand errors, seven, for instance, exceed four times the probable error. From (3) it follows that

$$c' = \pm 0.674 \mu_2^{\frac{1}{2}}.$$

### 3.

If  $aX$  be a multiple of an observed quantity  $X$ , in the observations of which the modulus is  $c$ , then the modulus in the corresponding system of errors of  $aX$  is clearly  $ac$ .

The probable error of the sum of two quantities affected by independent errors is the square root of the sum of the squares of their separate probable errors. Thus if  $X + Y = Z$ , and the moduli of the system of errors in  $X$  and  $Y$  be  $a$  and  $b$  respectively, then the law of facility of errors in  $Z$  is the same function  $\phi$  as before, but with a modulus  $= \sqrt{a^2 + b^2}$ .

For the error  $z$  in  $Z$  being the sum of an error  $x$  in the first system, and an error  $y = z - x$  in the second, the chance of the concurrence of errors between  $x$  and  $x + dx$ , and between  $z - x$  and  $z - x + dz$  is

$$\frac{1}{\pi a b} e^{-\frac{x^2}{a^2}} dx \cdot e^{-\frac{(z-x)^2}{b^2}} dz = \frac{dz}{\pi a b} e^{-\frac{z^2}{a^2+b^2}} e^{-\frac{a^2+b^2}{a^2 b^2} \left(z - \frac{z a^2}{a^2+b^2}\right)^2} dx.$$

To include all combinations this expression must be integrated, considering  $z$  constant, from  $x = -\infty$  to  $x + \infty$ . Thus, bearing in mind the integral (1), the probability of an error between  $z$  and  $z + dz$  is

$$\frac{1}{\sqrt{\pi}} e^{-\frac{z^2}{a^2+b^2}} \frac{dz}{\sqrt{a^2+b^2}},$$

so reproducing, in a remarkable manner, the function  $\phi$ .

The result would have been the same if we had had  $X - Y = Z$ ; and it may be extended to any number of quantities. Thus, if  $U$  be the mean of  $i$  measures of a quantity, the modulus being  $c$ , then it will follow that in the law of facility of error of  $U$  the modulus is

$$\left(\frac{c^2}{i^2} + \frac{c^2}{i^2} + \frac{c^2}{i^2} + \dots\right)^{\frac{1}{2}} = \frac{c}{\sqrt{i}};$$

so also if  $c'$  be the probable error of a single observation, that of the mean of  $i$  observations is  $c' : \sqrt{i}$ .

The fraction  $i : c^2$  is called the weight ( $= w$ ) of the determination of  $U$ ; so also  $w = i : 2\mu_2$ , and the probability of an error  $x$  in  $U$  is

$$y = \left(\frac{w}{\pi}\right)^{\frac{1}{2}} e^{-wx^2} dx. \quad (5)$$

So also the modulus for errors in  $aU$  is  $a : \sqrt{w}$ .

#### 4.

Let now  $U_0 = a_1 U_1 + a_2 U_2 + \dots$  be a linear function of measured quantities  $U_1, U_2, \dots$ , of which the weights are  $w_1, w_2, \dots$ , and the probable errors  $\epsilon_1, \epsilon_2, \dots$ ; then, from what has been proved in the preceding paragraph, it follows that the modulus for  $U_0$  is

$$\left(\frac{a_1^2}{w_1} + \frac{a_2^2}{w_2} + \frac{a_3^2}{w_3} + \dots\right)^{\frac{1}{2}};$$

and the probable error of  $U_0$  is

$$\pm (a_1^2 \epsilon_1^2 + a_2^2 \epsilon_2^2 + \dots)^{\frac{1}{2}} = \pm \rho \left(\frac{a_1^2}{w_1} + \frac{a_2^2}{w_2} + \frac{a_3^2}{w_3} + \dots\right)^{\frac{1}{2}}.$$

This we shall now apply to an important case. In calculations connected with geodesy it is often necessary to determine a system of unknown quantities  $x, y, z \dots$  from equations of the form

$$\begin{aligned} a_1 x + b_1 y + c_1 z + \dots + m_1 &= 0, \\ a_2 x + b_2 y + c_2 z + \dots + m_2 &= 0, \end{aligned} \quad (6)$$

and so on; the number of equations being greater than the number of unknowns. The coefficients are given numerical quantities, and  $m_1, m_2, \dots$  are observed quantities with weights  $w_1, w_2, \dots$ . On account of the errors in  $m_1, m_2, \dots$  the equations do not hold good; in fact, instead of zero in the right-hand members we must write  $e_1, e_2, \dots$  the actual errors of  $m_1, m_2, \dots$ . Now each of the quantities  $x, y, z, \dots$  must be made to depend on all the observations; let therefore the equations be multiplied by certain multipliers  $k_1, k_2, \dots$  and added together; also assume

$$\begin{aligned} k_1 a_1 + k_2 a_2 + k_3 a_3 + \dots &= 1, \\ k_1 b_1 + k_2 b_2 + k_3 b_3 + \dots &= 0, \\ k_1 c_1 + k_2 c_2 + k_3 c_3 + \dots &= 0, \\ &\&c.; \end{aligned} \quad (7)$$

then

$$x + k_1 m_1 + k_2 m_2 + k_3 m_3 \dots = k_1 e_1 + k_2 e_2 + k_3 e_3 \dots$$

Thus the probable error of  $x$  is

$$\pm \rho \left( \frac{k_1^2}{w_1} + \frac{k_2^2}{w_2} + \frac{k_3^2}{w_3} + \dots \right)^{\frac{1}{2}}.$$

The values of  $k$  must therefore be so determined that this shall be a minimum subject to the conditions (7). For the sake of simplicity, and as indeed the most ordinary case, suppose the weights equal, then we have to make  $k_1^2 + k_2^2 + \dots$  a minimum. Differentiating this expression and also the equations (7),

$$\begin{aligned} 0 &= k_1 dk_1 + k_2 dk_2 + k_3 dk_3 \dots, \\ 0 &= a_1 dk_1 + a_2 dk_2 + a_3 dk_3 \dots, \\ 0 &= b_1 dk_1 + b_2 dk_2 + b_3 dk_3 \dots; \end{aligned}$$

and so on. According to the usual method of the differential calculus, multiply these by multipliers  $-1, \lambda_1, \lambda_2, \dots$ , and adding together the equations, we get, on equating to zero the coefficients of  $dk_1, dk_2, dk_3, \dots$ ,

$$\begin{aligned} k_1 &= a_1 \lambda_1 + b_1 \lambda_2 + c_1 \lambda_3 + \dots, \\ k_2 &= a_2 \lambda_1 + b_2 \lambda_2 + c_2 \lambda_3 + \dots, \\ k_3 &= a_3 \lambda_1 + b_3 \lambda_2 + c_3 \lambda_3 + \dots, \\ &\quad \&c. \end{aligned}$$

Substitute these in (7), and for  $a_1 b_1 + a_2 b_2 + \dots$  put  $(ab)$ , so that  $(aa)$ , for instance, means the sum of the squares of the  $a$ 's; thus

$$\begin{aligned} 1 &= (aa) \lambda_1 + (ab) \lambda_2 + (ac) \lambda_3 + \dots, \\ 0 &= (ab) \lambda_1 + (bb) \lambda_2 + (bc) \lambda_3 + \dots, \\ 0 &= (ac) \lambda_1 + (bc) \lambda_2 + (cc) \lambda_3 + \dots, \\ &\quad \&c. \end{aligned}$$

Put  $\nabla$  for the determinant formed by the coefficients of this equation,  $[aa]$  for the minor of  $(aa)$ , &c., then

$$\nabla \lambda_1 = [aa], \quad \nabla \lambda_2 = [ab], \quad \nabla \lambda_3 = [ac];$$

so that

$$\begin{aligned} \nabla k_1 &= a_1 [aa] + b_1 [ab] + c_1 [ac] \dots, \\ \nabla k_2 &= a_2 [aa] + b_2 [ab] + c_2 [ac] \dots, \\ \nabla k_3 &= a_3 [aa] + b_3 [ab] + c_3 [ac] \dots, \\ &\quad \&c. \end{aligned}$$

Multiplying these by  $m_1, m_2, \dots$ , and adding

$$0 = \nabla x + (am) [aa] + (bm) [ab] + (cm) [ac] \dots$$

Now this, with symmetrical expressions for  $\nabla y$ ,  $\nabla z$ , ..., are what would have resulted from the solution of the equations

$$\begin{aligned}(aa)x + (ab)y + (ac)z + \dots (am) &= 0, \\ (ab)x + (bb)y + (bc)z + \dots (bm) &= 0, \\ (ac)x + (bc)y + (cc)z + \dots (cm) &= 0, \\ &\&c.\end{aligned}\tag{8}$$

and these equations are in fact what we should have arrived at if we had set out with the intention of determining  $x, y, z, \dots$ , so that the sum of the squares of the errors  $\Sigma(e^2)$ , or

$$\Sigma(ax + by + cz + \dots + m)^2$$

should be a minimum. Exactly in the same manner, if we had retained the separate values of  $w_1, w_2, \dots$ , we should have found that  $x, y, z, \dots$  are to be determined so as to make

$$\Sigma w(ax + by + cz + \dots + m)^2\tag{9}$$

or  $\Sigma(w e^2)$ , a minimum. This case practically therefore reduces to the former, if we first multiply each equation by the square root of the corresponding weight.

## 5.

Returning to the case of equal weights, let us determine the probable errors of any linear function, as  $fx + gy + hz \dots$  of the obtained values of  $x, y, z, \dots$ . Let the solution of the equations (8) be written thus

$$\begin{aligned}0 &= x + (aa)(am) + (a\beta)(bm) + (a\gamma)(cm) \dots, \\ 0 &= y + (a\beta)(am) + (\beta\beta)(bm) + (\beta\gamma)(cm) \dots, \\ 0 &= z + (a\gamma)(am) + (\beta\gamma)(bm) + (\gamma\gamma)(cm) \dots, \\ &\&c.\end{aligned}\tag{10}$$

Then, if

$$\begin{aligned}0 &= A + (aa)f + (a\beta)g + (a\gamma)h \dots, \\ 0 &= B + (a\beta)f + (\beta\beta)g + (\beta\gamma)h \dots, \\ 0 &= C + (a\gamma)f + (\beta\gamma)g + (\gamma\gamma)h \dots, \\ &\&c.,\end{aligned}\tag{11}$$

it follows that,

$$\begin{aligned}0 &= f + (aa)A + (ab)B + (ac)C \dots, \\ 0 &= g + (ab)A + (bb)B + (bc)C \dots, \\ 0 &= h + (ac)A + (bc)B + (cc)C \dots, \\ &\&c. ;\end{aligned}\tag{12}$$

and thus

$$\begin{aligned} fx + gy + zh \dots &= A(am) + B(bm) + C(cm) \dots, \\ &= (Aa_1 + Bb_1 + Cc_1 \dots) m_1 + (Aa_2 + Bb_2 + Cc_2 \dots) m_2 + \dots \end{aligned}$$

Let  $S$  be the sum of the squares of these coefficients of  $m_1, m_2, \dots$ , then  $S =$

$$A(A(aa) + B(ab) + C(ac) \dots) + B(A(ab) + B(bb) + C(bc) \dots) \dots;$$

which by (11) and (12) gives finally

$$\begin{aligned} S &= (aa)f^2 + (a\beta)fg + (a\gamma)fh \dots & (13) \\ &+ (a\beta)fg + (\beta\beta)g^2 + (\beta\gamma)gh \dots \\ &+ (a\gamma)fh + (\beta\gamma)gh + (\gamma\gamma)h^2 \dots; \end{aligned}$$

when therefore we require the probable error of a function of  $xyz \dots$ , it is necessary in solving the equations (8) to leave the absolute terms symbolical. Thus we have the required numerical quantities  $(aa), (a\beta), \dots$

The probable error of  $fx + gy + hz \dots$  might be taken as  $\epsilon \sqrt{S}$  where  $\epsilon$  is the probable error of one of the equally well observed quantities  $m$ . The value of  $\epsilon$  is generally only to be determined by consideration of the residual errors of the equations: let  $\sigma$  be the sum of the squares of these residual errors,  $i$  the number of the equations,  $j$  that of the quantities  $x, y, z, \dots$ , then the probable error of  $fx + gy + hz \dots$  is

$$\pm 0.674 \left( \frac{S \sigma}{i-j} \right)^{\frac{1}{2}}.$$

For the necessity of dividing by  $i-j$  rather than  $i$  we must refer to treatises on least squares, for instance, Gauss, *Theoria Combinationis*, § 38, or Chauvenet's *Spherical and Practical Astronomy*, Vol. II, pages 519-521.

A check on the calculated sum  $\sigma$  is afforded by the easily verified equation

$$\sigma = (m^2) + (am)x + (bm)y + (cm)z + \dots$$

Suppose the case of only two unknown quantities, then (10) becomes

$$\begin{aligned} 0 &= x + \frac{(b^2)(am) - (ab)(bm)}{(a^2)(b^2) - (ab)^2}, \\ 0 &= y + \frac{-(ab)(am) + (a^2)(bm)}{(a^2)(b^2) - (ab)^2}; \end{aligned}$$



and the probable error of  $fx + gy$  is,

$$\pm 0.674 \left( \frac{\sigma}{i-2} \right)^{\frac{1}{2}} \left\{ \frac{(b^2)f^2 - 2(ab)fg + (a^2)g^2}{(a^2)(b^2) - (ab)^2} \right\}^{\frac{1}{2}}; \quad (14)$$

if  $f+g = 1$ , the probable error is a minimum, when

$$f \{(ab) + (b^2)\} - g \{(a^2) + (ab)\} = 0.$$

### 6.

The following numerical examples will serve to elucidate the preceding theory. The annexed table contains in the first, third, fifth, and seventh columns, forty independent micro-meter measurements of equal weight, made for the purpose of determining the error of position of a certain division line on a standard scale.

$x$	ERROR.	$x$	ERROR.	$x$	ERROR.	$x$	ERROR.
3.68	- 0.25	2.81	- 1.12	5.48	+ 1.55	3.28	- 0.65
3.11	- 0.82	4.65	+ 0.72	3.76	- 0.17	3.78	- 0.15
4.76	+ 0.83	3.27	- 0.66	4.59	+ 0.66	3.22	- 0.71
2.75	- 1.18	4.08	+ 0.15	2.64	- 1.29	3.98	+ 0.05
4.15	+ 0.22	4.51	+ 0.58	2.98	- 0.95	3.91	- 0.02
5.08	+ 1.15	4.43	+ 0.50	4.21	+ 0.28	5.21	+ 1.28
2.95	- 0.98	3.43	- 0.50	5.23	+ 1.30	4.43	+ 0.50
6.35	+ 2.42	3.26	- 0.67	4.45	+ 0.52	2.28	- 1.65
3.78	- 0.15	2.48	- 1.45	3.95	+ 0.02	4.10	+ 0.17
4.49	+ 0.56	4.84	+ 0.91	2.66	- 1.27	4.18	+ 0.25

The arithmetic mean of the measured quantities gives  $x = 3.93$ ; and in the alternate columns are placed the errors, or differences between the individual measures and their mean. The sum of the squares of these errors is 32.635, hence the probable error of a single determination is

$$\pm .674 \left( \frac{32.635}{40-1} \right)^{\frac{1}{2}} = \pm 0.62.$$

Now if we arrange the errors in order of magnitude, we find that those two which occupy the centre position and so represent the probable error are + 0.66 and - 0.66. Again, as we have seen at page 55, the number of errors out of 40

which should be less than half the probable error is 11, the actual number is 12. The number which according to theory should be under twice the probable error is 33, the actual number is 32. Finally, two errors should exceed three times the probable error, the actual number is 1.

The probable error of the determined value of  $x$  is

$$\pm 0.62 : \sqrt{40} = \pm 0.097.$$

The unit of length in these measures is the millionth of a yard.

Take now a case of two unknown quantities. The observed differences of length between the platinum metre of the Royal Society and a steel metre of the Ordnance Survey at certain temperatures are given in the accompanying table (*Comparisons of Standards*, page 171):—

DIFF.	TEMP.	DIFF.	TEMP.	DIFF.	TEMP.	DIFF.	TEMP.
5.76	65.16	6.47	63.76	41.59	36.12	36.57	35.22
6.69	65.20	7.23	63.93	38.53	36.06	38.54	37.33
5.00	65.45	4.17	64.21	41.08	36.08	39.47	37.49
5.90	65.51	6.32	63.90	39.13	36.23	41.10	37.60
6.39	64.57	7.31	64.08	41.80	35.57	40.10	37.79
5.77	64.77	38.07	38.36	38.65	35.48		
3.30	64.88	39.29	33.35	41.26	35.94		

Let  $x$  be the excess of length of the platinum metre at  $62^\circ$ , and  $y$  its excess at  $32^\circ$ , above the steel metre at the same temperatures, then at the temperature  $t$  the excess is

$$x \frac{t-32}{30} + y \frac{62-t}{30};$$

and this is to be equated to the observed difference. The first three equations for instance are

$$1.105x - 0.105y - 5.76 = 0,$$

$$1.107x - 0.107y - 6.69 = 0,$$

$$1.115x - 0.115y - 5.00 = 0,$$

and so on. In forming the sums of squares and products

$$(aa), (ab), (bb), (am), (bm),$$

it is to be remarked that in this case, since in each equation  $a + b = 1$ , we have

$$(a^2) + (ab) = (a) \quad \text{and} \quad (ab) + (b^2) = (b);$$

thus the final equations corresponding to (8) are found to be

$$14.549724x + 0.684874y - 163.0507 = 0,$$

$$0.684874x + 10.080524y - 462.4393 = 0.$$

The solution, leaving the absolute terms symbolical, gives

$$x + .068950(am) - .004685(bm) = 0,$$

$$y - .004685(am) + .099522(bm) = 0.$$

Restoring the numerical values of  $(am)$ ,  $(bm)$ , we have  $x = 9.08$ ,  $y = 45.26$ , and on substituting these in the 26 equations, the residual errors are

- 0.49	- 0.41	- 0.48	- 1.69	- 0.85	+ 0.29
- 1.47	- 0.03	+ 2.24	- 1.30	+ 2.41	- 0.83
- 0.08	+ 2.31	+ 0.47	+ 1.83	- 0.75	- 2.59
- 1.05	+ 0.49	- 0.74	- 0.74	+ 4.81	- 1.82
		- 0.48	+ 1.03		

the sum of the squares of which is 66.03, so that the probable error of a single comparison is

$$\pm 0.674 \left( \frac{66.03}{26-2} \right)^{\frac{1}{2}} = \pm 1.12;$$

and the probable error of  $x$  and  $y$  are

$$x \dots \pm 1.12 (.0690)^{\frac{1}{2}} = \pm 0.29,$$

$$y \dots \pm 1.12 (.0995)^{\frac{1}{2}} = \pm 0.35.$$

We may calculate by (14) the probable error of the difference of length corresponding to any temperature  $\tau$ , and it is easy to prove that this is a minimum when  $\tau$  is the mean of all the observed temperatures.

## 7.

A case of frequent occurrence is that in which we have the observed values of a number of quantities  $u_1, u_2, \dots, u_i$ , which, though independently observed, have yet necessary relations amongst themselves expressed by  $j (< i)$  linear equations. Let  $U_1, U_2, \dots, U_i$  be the observed values with weights  $w_1, w_2, \dots$ ; then if  $x_1, x_2, \dots, x_i$  are the errors of  $U_1, U_2, \dots, U_i$ , they are connected by  $j$  equations of the form

$$0 = a + a_1 x_1 + a_2 x_2 + a_3 x_3 \dots \quad (15)$$

Now the probability of the concurrence of this system of errors may be thus expressed according to (5),

$$P = Ce^{-w_1 x_1^2 - w_2 x_2^2 - w_3 x_3^2 - \dots}$$

being the product of the separate independent probabilities. Therefore, amongst the indefinitely numerous systems of errors which satisfy the  $j$  equations of condition, we must select that which corresponds to the maximum value of  $P$ . But  $P$  is a maximum when

$$w_1 x_1^2 + w_2 x_2^2 + w_3 x_3^2 + \dots \tag{16}$$

is a minimum. This, it is to be observed, corresponds with (9). Thus,  $x_1, x_2, \dots$  are to be determined so as to make (16) a minimum while satisfying the conditions (15): a definite problem in the differential calculus.

Suppose, for instance, that the observed values of the angles  $A, B, C$  of a triangle have the weights  $u, v, w$ . Let  $x, y, z$  be the errors of the observed values, then since the true sum of the angles is known, we have a connection established between  $x, y, z$ : viz. if  $\epsilon$  be the error of the sum of the observed angles

$$x + y + z = \epsilon;$$

then  $x, y, z$  must be determined so that

$$u x^2 + v y^2 + w z^2 = \text{a minimum.}$$

Differentiating these two equations, and comparing the coefficients of  $dx, dy, dz$ , it appears that

$$u x = v y = w z.$$

Therefore

$$x = \frac{\frac{\epsilon}{u}}{\frac{1}{u} + \frac{1}{v} + \frac{1}{w}},$$

$$y = \frac{\frac{\epsilon}{v}}{\frac{1}{u} + \frac{1}{v} + \frac{1}{w}},$$

$$z = \frac{\frac{\epsilon}{w}}{\frac{1}{u} + \frac{1}{v} + \frac{1}{w}}.$$

Thus,  $A, B, C$  being the true angles, and  $e_1, e_2, e_3$  the actual errors of the observed angles, the adopted values are

$$\mathfrak{A} = A + e_1 - \frac{e_1 + e_2 + e_3}{\frac{1}{u} + \frac{1}{v} + \frac{1}{w}} \cdot \frac{1}{u},$$

$$\mathfrak{B} = B + e_2 - \frac{e_1 + e_2 + e_3}{\frac{1}{u} + \frac{1}{v} + \frac{1}{w}} \cdot \frac{1}{v},$$

$$\mathfrak{C} = C + e_3 - \frac{e_1 + e_2 + e_3}{\frac{1}{u} + \frac{1}{v} + \frac{1}{w}} \cdot \frac{1}{w}.$$

The actual error of any function as  $\alpha \mathfrak{A} + \beta \mathfrak{B} + \gamma \mathfrak{C}$  of the adopted angles is thus

$$(\alpha - w'K)e_1 + (\beta - w'K)e_2 + (\gamma - w'K)e_3,$$

where

$$\frac{1}{w'} = \frac{1}{u} + \frac{1}{v} + \frac{1}{w} \quad K = \frac{\alpha}{u} + \frac{\beta}{v} + \frac{\gamma}{w}.$$

Now the squares of the moduli for the law of facility of error in the observed angles, that is for  $e_1, e_2, e_3$ , are the reciprocals of  $u, v, w$ , so that the square of the modulus for errors in  $\alpha \mathfrak{A} + \beta \mathfrak{B} + \gamma \mathfrak{C}$  is

$$\frac{1}{u} (\alpha - w'K)^2 + \frac{1}{v} (\beta - w'K)^2 + \frac{1}{w} (\gamma - w'K)^2,$$

which may be put in the form

$$\frac{u(\beta - \gamma)^2 + v(\gamma - \alpha)^2 + w(\alpha - \beta)^2}{uv + vw + wu};$$

and the probable error is the square root of this multiplied by  $\rho = .477$ . If, for instance, the side  $c$  be given, the probable error of the calculated side  $a$  is

$$\pm \rho a \left\{ \frac{u \cot^2 C + v (\cot A + \cot C)^2 + w \cot^2 A}{uv + vw + wu} \right\}^{\frac{1}{2}}.$$

If the three angles be equally well observed, each having the probable error  $\varepsilon$ , that of  $a$  is

$$\pm \varepsilon \left( \frac{2}{3} \right)^{\frac{1}{2}} (\cot^2 A + \cot A \cot C + \cot^2 C)^{\frac{1}{2}} a. \quad (17)$$

In the application of such a formula as this, it is necessary to bear in mind that it is based distinctly on the hypothesis of the errors following the established law of facility of error

in (2). It could not be derived otherwise—if, for instance, the observations were liable to unknown constant error. It is safer therefore, if there be any doubt on this point, to obtain  $\epsilon$  from the differences between the individual observations and  $\mathfrak{A}$ ,  $\mathfrak{B}$ ,  $\mathfrak{C}$ , than from the differences with the respective means. Suppose the probable errors of the observed angles estimated in the last-mentioned manner (namely, from the agreement of the observations at each station, without any reference to the sum of the angles) to be each  $\pm 0''.4$ ; then the probable error of their sum is  $\pm 0''.4\sqrt{3} = 0''.7$ . Now, as we have seen (page 55), in a system of errors in which 0.7 is the probable error, only about one error in 143 exceeds

$$4 \times 0''.7 = 2''.8;$$

therefore, it is very improbable that the sum of such angles should have an error of  $2''.8$ . Still it might occur. But if the error were, say  $4''$ , we should be compelled to admit the existence of a constant error, and in this case the formula referred to would be deceptive.

In extensive triangulations it is found that the errors in the sums of the observed angles of triangles are somewhat larger in the long run than what would be expected from the agreement of the observations of angles among themselves. Hence it is usual to estimate the precision of observed angles by reference to these errors of triangle sums. On this subject much valuable matter will be found in the second volume of the *Account of the Great Trigonometrical Survey of India*, by General Walker, C.B., R.E., Surveyor-General of India.

## CHAPTER IV.

### THEORY OF THE FIGURE OF THE EARTH.

IN the third book of Newton's *Principia* (1687), *propositions* 18, 19, 20,—will be found the first theoretical investigation of the figure of the earth based on the newly established doctrine of gravitation. Newton determined the ratio of the axes of the earth on the assumption that an ellipsoid of revolution is a form of equilibrium of a homogeneous fluid mass rotating with uniform angular velocity: a proposition fully established some years after by Maclaurin.

In 1743 was published Clairaut's celebrated work<sup>1</sup> on the figure of the earth. In a very valuable *History of the Mathematical Theories of Attraction and the Figure of the Earth*, by I. Todhunter, M.A., F.R.S., 1873, at page 229, vol. I, the author remarks concerning Clairaut, 'In the Figure of the Earth no other person has accomplished so much as Clairaut; and the subject remains at present substantially as he left it, though the form is different. The splendid analysis which Laplace supplied, adorned but did not really alter the theory which started from the creative hands of Clairaut.' We shall in this chapter give some of Clairaut's results, basing them on the very beautiful theorem due to Maclaurin and Laplace—'The potentials of two confocal ellipsoids at any point external to both are as their masses.'

For an account of the investigations of the many eminent

<sup>1</sup> *Théorie de la figure de la terre tirée des principes de l'hydrostatique*: par Clairaut, de l'Académie royale des Sciences, et de la Société royale de Londres. Seconde édition. Paris, 1808.



mathematicians who have dealt with the theory of the figure of the earth, we must refer to Mr. Todhunter's interesting volumes.

## 1.

Of the various methods of proof that have been given of Laplace's Theorem, one of the most elegant is that of Rodrigues, to be found in *Corresp. sur l'Ecole Polytech.*, tome iii. pp. 361-385<sup>1</sup>. It is based upon the following lemma, which is easily proved: viz. if  $M$  be any point,  $P$  a point on a closed surface,  $PQ$  the normal drawn outward at  $P$ ,  $dS$  the element of surface at this point, then the integral

$$\int \frac{dS \cos MPQ}{MP^2}$$

taken over the whole surface, is equal to 0 or  $-4\pi$  according as  $M$  is exterior to or interior to the surface.

Let  $f, g, h$  be the coordinates of any point,  $a, b, c$  the semi-axes of an ellipsoid,  $\delta a, \delta b, \delta c$  increments of  $a, b, c$ , such that  $a\delta a = b\delta b = c\delta c = \text{a constant}$ , say  $=\frac{1}{2}\delta t$ ; then it is clear that by these variations we pass from the original ellipsoid to an adjacent confocal ellipsoid. The potential of the ellipsoid is

$$V = \iiint \frac{dx dy dz}{R},$$

where

$$R^2 = (x-f)^2 + (y-g)^2 + (z-h)^2.$$

Transform the above integral by putting

$$x = ar \cos \theta, \quad y = br \sin \theta \cos \phi, \quad z = cr \sin \theta \sin \phi;$$

then the element of mass becomes  $abc r^2 \sin \theta d\phi d\theta dr$ , and

$$\frac{V}{abc} = \int_0^{2\pi} \int_0^\pi \int_0^1 \frac{r^2 \sin \theta d\phi d\theta dr}{R}.$$

The variation of the function  $V + abc$  in passing from the ellipsoid  $abc$  to the adjacent confocal ellipsoid is

$$\delta \left( \frac{V}{abc} \right) = \int_0^{2\pi} \int_0^\pi \int_0^1 \delta \left( \frac{1}{R} \right) r^2 \sin \theta d\phi d\theta dr.$$

<sup>1</sup> See also Todhunter, *Attractions, &c.*, ii. 243; and the *Quarterly Journal of Mathematics*, vol. ii. pp. 333-7.



Now  $\delta x = r \cos \theta \delta a = \frac{x}{a} \delta a$ , and so on; thus

$$\delta x = \frac{x}{a} \delta a, \quad \delta y = \frac{y}{b} \delta b, \quad \delta z = \frac{z}{c} \delta c;$$

so that

$$\delta \frac{1}{R} = -\frac{\delta t}{2R^3} \left\{ (x-f) \frac{x}{a^2} + (y-g) \frac{y}{b^2} + (z-h) \frac{z}{c^2} \right\},$$

or, putting  $N$  for the quantity in brackets,

$$\delta \left( \frac{V}{abc} \right) = -\frac{\delta t}{2} \int_0^{2\pi} \int_0^\pi \int_0^1 \frac{N}{R^3} r^2 \sin \theta \, d\phi \, d\theta \, dr, \quad (1)$$

the integration extending throughout the ellipsoid. Consider now the shell which is bounded by the ellipsoidal surface whose semiaxes are  $ra, rb, rc$ , and that whose semiaxes are  $(r+dr)a, (r+dr)b, (r+dr)c$ . Let  $\epsilon$  be the thickness of this shell, then  $\lambda, \mu, \nu$  being the direction cosines of the normal at  $xyz$  on the inner shell,

$$\begin{aligned} \frac{x^2}{a^2} + \frac{y^2}{b^2} + \frac{z^2}{c^2} &= r^2, \\ \frac{(x+\lambda\epsilon)^2}{a^2} + \frac{(y+\mu\epsilon)^2}{b^2} + \frac{(z+\nu\epsilon)^2}{c^2} &= (r+dr)^2; \\ \therefore \left( \frac{\lambda x}{a^2} + \frac{\mu y}{b^2} + \frac{\nu z}{c^2} \right) \epsilon &= r \, dr; \end{aligned}$$

but  $\lambda \left( \frac{x^2}{a^4} + \frac{y^2}{b^4} + \frac{z^2}{c^4} \right)^{\frac{1}{2}} = \frac{x}{a^2}$ , and so for  $\mu, \nu$ ; hence

$$\epsilon \frac{x}{a^2} = \lambda r \, dr, \quad \epsilon \frac{y}{b^2} = \mu r \, dr, \quad \epsilon \frac{z}{c^2} = \nu r \, dr.$$

Let  $dS$  be an element of one of the surfaces of the shell, then the element of volume is  $\epsilon dS$ , by which we may replace  $abc r^2 \sin \theta \, d\phi \, d\theta$  in the triple integral (1). Thus we have

$$\begin{aligned} \frac{N}{R^3} r^2 \sin \theta \, d\phi \, d\theta \, dr &= \frac{1}{abc} \cdot \frac{dS}{R^2} \cdot \frac{\epsilon N}{R} \\ &= \frac{1}{abc} \frac{dS}{R^2} \left\{ \frac{x-f}{R} \lambda + \frac{y-g}{R} \mu + \frac{z-h}{R} \nu \right\} r \, dr \\ &= -\frac{1}{abc} \cdot \frac{\cos \phi \, dS}{R^2} r \, dr, \end{aligned}$$

where  $\phi$  is the angle at  $xyz$  between the normal drawn out-

wards there and the straight line drawn from thence to  $fgk$ . Consequently

$$\delta\left(\frac{V}{abc}\right) = \frac{1}{2} \frac{\delta t}{abc} \int \left\{ \int \frac{\cos \phi dS}{R^2} \right\} r dr,$$

the integration with respect to  $S$  extending over the whole surface of the ellipsoid whose semiaxes are  $ra, rb, rc$ .

Therefore, by the Lemma at the commencement of this investigation, if the point  $fgk$  be outside the ellipsoid,  $V:abc$  is constant; that is, if  $M$  be the mass of the ellipsoid  $V:M$  is constant; that is, it is independent of the lengths of  $abc$ , depending only on the eccentricity of the ellipsoid. In other words, the potentials of confocal ellipsoids at an external point are as their masses.

## 2.

An expression for the potential of an ellipsoid at an internal point may be derived from the last-written equation. When  $fgk$  is internal, we have by virtue of the Lemma

$$\delta\left(\frac{V}{abc}\right) = -\frac{2\pi\delta t}{abc} \int r dr,$$

where the integration is to be taken for all the shells outside the particle, viz. from  $r = r'$  to  $r = 1$ , where

$$\frac{f^2}{a^2} + \frac{g^2}{b^2} + \frac{h^2}{c^2} = r'^2,$$

so that

$$\delta\left(\frac{V}{abc}\right) = \frac{\pi\delta t}{abc} \left(\frac{f^2}{a^2} + \frac{g^2}{b^2} + \frac{h^2}{c^2} - 1\right).$$

The right hand member of this equation is the increment of the function  $V:abc$  in passing from the ellipsoid  $abc$  to the confocal ellipsoid  $a + \delta a, b + \delta b, c + \delta c$ , where

$$a\delta a = b\delta b = c\delta c = \frac{1}{2}\delta t.$$

We may now use the ordinary  $d$  instead of  $\delta$ , and putting

$$a^2 = a^2 + t, \quad b^2 = \beta^2 + t, \quad c^2 = \gamma^2 + t,$$

we have

$$\begin{aligned} \frac{d}{dt} \frac{V}{\{(a^2 + t)(\beta^2 + t)(\gamma^2 + t)\}^{\frac{1}{2}}} \\ = \frac{\pi}{\{(a^2 + t)(\beta^2 + t)(\gamma^2 + t)\}^{\frac{1}{2}}} \left\{ \frac{f^2}{a^2 + t} + \frac{g^2}{\beta^2 + t} + \frac{h^2}{\gamma^2 + t} - 1 \right\}. \end{aligned}$$

Integrate from  $t = 0$  to  $t = \infty$ , since  $\frac{V}{M}$  vanishes when  $t$  is infinite, then we have

$$V = -\pi a \beta \gamma \int_0^\infty \frac{dt}{Q} \left\{ \frac{f^2}{a^2+t} + \frac{g^2}{\beta^2+t} + \frac{h^2}{\gamma^2+t} - 1 \right\}, \quad (2)$$

where  $Q = \{(a^2+t)(\beta^2+t)(\gamma^2+t)\}^{\frac{1}{2}}$ . This expresses the potential of the ellipsoid whose semiaxes are  $a\beta\gamma$ , at an internal point  $fgh$ .

### 3.

We may adapt the result just arrived at, to the case of a very nearly spherical ellipsoid in the following manner. Let the semiaxes squared be  $k^2 + \epsilon_1$ ,  $k^2 + \epsilon_2$ ,  $k^2 + \epsilon_3$ , where  $\epsilon_1$ ,  $\epsilon_2$ ,  $\epsilon_3$  are very small quantities whose squares are to be neglected, and  $\epsilon_1 + \epsilon_2 + \epsilon_3 = 0$ . Put  $k^2 + t = u$ , and

$$Q^2 = (u + \epsilon_1)(u + \epsilon_2)(u + \epsilon_3),$$

then  $Q = u^{\frac{3}{2}}$ ; and  $M$  being the mass of the ellipsoid

$$\pi k^3 = \frac{3}{4} M.$$

Thus, at an internal point  $fgh$ ,

$$V = \frac{3}{4} M \int \frac{du}{Q} \left\{ 1 - \frac{f^2}{u + \epsilon_1} - \frac{g^2}{u + \epsilon_2} - \frac{h^2}{u + \epsilon_3} \right\},$$

the integral being taken from  $u = k^2$  to  $u = \infty$ : thus

$$V = \frac{3}{4} M \int_{k^2}^\infty \frac{du}{u^{\frac{3}{2}}} \left\{ 1 - \frac{r^2}{u} + \frac{\epsilon_1 f^2 + \epsilon_2 g^2 + \epsilon_3 h^2}{u^2} \right\},$$

where  $r^2 = f^2 + g^2 + h^2$ . The result of the integration is

$$V = M \left\{ \frac{3}{2k} - \frac{r^2}{2k^3} + \frac{3}{10} \frac{\epsilon_1 f^2 + \epsilon_2 g^2 + \epsilon_3 h^2}{k^5} \right\}, \quad (3)$$

which is the potential required.

From this we may obtain the potential of an ellipsoid at an external point. When the internal point  $fgh$  arrives at, or is on the surface,

$$\frac{f^2}{k^2 + \epsilon_1} + \frac{g^2}{k^2 + \epsilon_2} + \frac{h^2}{k^2 + \epsilon_3} = 1;$$

whence

$$r^2 = k^2 + \frac{\epsilon_1 f^2 + \epsilon_2 g^2 + \epsilon_3 h^2}{k^2};$$

$$\therefore 3 \frac{r}{k} - \frac{r^3}{k^3} = 2,$$

$$\text{or} \quad \frac{3}{2} \cdot \frac{1}{k} - \frac{r^2}{2k^3} = \frac{1}{r}.$$

Thus, for a point on the surface,

$$V = M \left\{ \frac{1}{r} + \frac{3}{10} \frac{\epsilon_1 f^2 + \epsilon_2 g^2 + \epsilon_3 h^2}{r^5} \right\}. \quad (4)$$

Let the ellipsoid to which this refers be called the ellipsoid  $E$ , and let the point  $fgh$  on its surface be called  $R$ . Let there be another ellipsoid  $E'$  confocal with  $E$ , and interior to it, its mass  $M'$ , and squared semiaxes  $k_1^2 + \epsilon_1$ ,  $k_1^2 + \epsilon_2$ ,  $k_1^2 + \epsilon_3$ . Let  $V'$  be the potential at  $R$  of  $E'$ , then by Laplace's Theorem

$$V' : M' = V : M.$$

Therefore, in the preceding equation we may substitute  $V'$  and  $M'$  for  $V$  and  $M$ , or in other words, that equation expresses the potential of an ellipsoid at an external point.

If  $abc$  be the semiaxes of any ellipsoid, and

$$e_1^2 = b^2 - c^2, \quad e_2^2 = c^2 - a^2, \quad e_3^2 = a^2 - b^2,$$

the potential at an external point is expressed by the series <sup>1</sup>

$$\begin{aligned} V = \frac{M}{r} - \frac{M}{15r^3} \{ P_2' (e_2^2 - e_3^2) + P_2'' (e_3^2 - e_1^2) + P_2''' (e_1^2 - e_2^2) \} \\ - \frac{3M}{35r^5} \{ P_4' e_2^2 e_3^2 + P_4'' e_3^2 e_1^2 + P_4''' e_1^2 e_2^2 \} \\ - \frac{M}{42r^7} \{ P_6' e_2^2 e_3^2 (e_2^2 - e_3^2) + P_6'' e_3^2 e_1^2 (e_3^2 - e_1^2) \\ + P_6''' e_1^2 e_2^2 (e_1^2 - e_2^2) + P e_1^2 e_2^2 e_3^2 \}, \end{aligned}$$

and so on; where  $P_i'$ ,  $P_i''$ ,  $P_i'''$  are what Legendre's coefficient of the order  $i$  becomes when the direction cosines of the line  $r$  are substituted severally for the variable involved in the expression for  $P_i$ , and  $P$  is a symmetrical function of the direction cosines. The values of  $P_1$ ,  $P_2$ ,  $P_4$ ,  $P_6$  are

$$P_1 = \mu,$$

$$P_2 = \frac{3}{2} \mu^2 - \frac{1}{2},$$

$$P_4 = \frac{5.7}{2.4} \mu^4 - \frac{3.5}{2.4} 2\mu^2 + \frac{1.3}{2.4},$$

$$P_6 = \frac{7.9.11}{2.4.6} \mu^6 - \frac{5.7.9}{2.4.6} 3\mu^4 + \frac{3.5.7}{2.4.6} 3\mu^2 - \frac{1.3.5}{2.4.6}.$$

<sup>1</sup> *Philosophical Magazine*, December, 1877.

We see from the law of this series for  $V$  that for an external point, however near it may be to the ellipsoid, if the ellipsoid be very nearly a sphere, so that small quantities of the second order ( $e^4$ ) may be neglected, then  $V$  is expressed by two terms of this series. Supposing the semiaxes squared to be as before,  $k^2 + \epsilon_1$ ,  $k^2 + \epsilon_2$ ,  $k^2 + \epsilon_3$ , where  $\epsilon_1 + \epsilon_2 + \epsilon_3 = 0$ , then we easily find

$$e_2^2 - e_3^2 = -3\epsilon_1, \quad e_3^2 - e_1^2 = -3\epsilon_2, \quad e_1^2 - e_2^2 = -3\epsilon_3;$$

also

$$P_2' = \frac{3}{2} \frac{f^2}{r^2} - \frac{1}{2},$$

$$P_2'' = \frac{3}{2} \frac{g^2}{r^2} - \frac{1}{2},$$

$$P_2''' = \frac{3}{2} \frac{h^2}{r^2} - \frac{1}{2};$$

substituting these values in the second term of the series, we get again the expression (4).

#### 4.

We shall now take the case of an oblate spheroid<sup>1</sup>, and obtain an expression for the potential of a spheroidal shell at an external and at an internal point. Let the semiaxes of an ellipse be  $c(1 + \frac{1}{3}e)$  and  $c(1 - \frac{2}{3}e)$ ,  $r, \theta$  the polar coordinates of a point in this ellipse,  $\theta$  being the angle between  $r$  and the minor semiaxis, then if we neglect the square of  $e$ ,

$$\frac{r^2 \sin^2 \theta}{c^2 (1 + \frac{2}{3}e)} + \frac{r^2 \cos^2 \theta}{c^2 (1 - \frac{1}{3}e)} = 1$$

is the equation of the ellipse. Put  $\cos \theta = \mu$ , and the equation may be written in the form

$$r = c \{1 + e(\frac{1}{3} - \mu^2)\}.$$

This ellipse, by rotation round its minor axis, generates a spheroid whose mass to unit density is  $\frac{4}{3}\pi c^3$ , so that  $c$  is the mean radius of the surface, and  $e$ , which is called the ellipticity, is the ratio of the difference of the semiaxes to the mean

<sup>1</sup> The word 'spheroid' is not used in this book in any other sense than as meaning an ellipsoid of revolution.

radius of the surface. In order to express the potential of this spheroid we must in the formulae for the ellipsoid put simply

$$k^2 = c^2, \quad \epsilon_1 = \frac{2}{3} ec^2 = \epsilon_2, \quad \epsilon_3 = -\frac{1}{3} ec^2;$$

thus we get for an internal point the potential

$$\Pi_1 = 2\pi \left( c^2 - \frac{r^2}{3} \right) + \frac{4}{3} \pi e r^2 \left( \frac{1}{3} - \mu^2 \right),$$

and for an external point

$$\Pi_0 = \frac{4\pi c^3}{3r} + \frac{4\pi ec^5}{5r^3} \left( \frac{1}{3} - \mu^2 \right).$$

Next take the shell, whose interior surface is a spheroid, whose elements are  $c, e$ , and its exterior surface the spheroid whose elements are  $c + dc$  and  $e + de$ . Let  $e$  be a function of  $c$ , so that

$$de = \frac{de}{dc} dc;$$

then the potentials of the shell at an internal and an external point are respectively

$$\frac{d\Pi_1}{d} dc, \quad \text{and} \quad \frac{d\Pi_0}{dc} dc,$$

the density being unity; if the density of the shell be  $\rho$ , the potentials are,

$$\text{at an external point,} \quad \rho \frac{d\Pi_0}{dc} dc;$$

$$\text{at an internal point,} \quad \rho \frac{d\Pi_1}{dc} dc.$$

## 5.

Now consider a spheroid in which the density is not uniform, but varies in such a manner that the surfaces of constant density are concentric and coaxial spheroids, the external surface being one of them. The ellipticity of the surfaces as well as the density is a function of the distance from the centre. Suppose that  $r = c \{ 1 + e \left( \frac{1}{3} - \mu^2 \right) \}$  is the equation of the generating curve of the surface of density  $\rho$ , then  $c$  being the independent variable,  $e$  and  $\rho$  are functions of  $c$ . Thus we may in other words suppose the spheroid formed of homogeneous spheroidal shells of which the ellipticity and density

are functions of  $c$ . The external surface we shall particularise by the accented letters  $c'$ ,  $e'$ . Take a point  $P$  within the body, let it be situated on the surface whose elements are  $c$ ,  $e$ , its polar coordinates  $r$  and  $\mu$ . It is required to express the potential of the whole mass at  $P$ .

In the preceding section we obtained an expression for the potential, whether at an outside or inside point, of a shell such as the spheroid we are supposing is formed of. If we integrate the expression for the potential of a shell at an outside point we get

$$\int_0^{c'} \rho \frac{d\Pi_0}{dc} dc,$$

taken between the limits 0 and  $c'$ , for the potential at  $P$  of the assemblage of shells which do not enclose  $P$ . Again, integrating from  $c$ , to  $c'$  the expression for the potential of a shell at an internal point, we get for the potential at  $P$  of the assemblage of shells which enclose  $P$

$$\int_c^{c'} \rho \frac{d\Pi_1}{dc} dc;$$

thus the potential of the spheroid is

$$\begin{aligned} V &= \int_0^{c'} \rho \frac{d\Pi_0}{dc} dc + \int_c^{c'} \rho \frac{d\Pi_1}{dc} dc \\ &= \frac{4\pi}{r} \int_0^{c'} \rho c^2 dc + \frac{4\pi}{5r^3} \left(\frac{1}{3} - \mu^2\right) \int_0^{c'} \rho \frac{d}{dc}(ec^5) dc \quad (5) \\ &\quad + 4\pi \int_c^{c'} \rho c dc + \frac{4}{3} \pi r^2 \left(\frac{1}{3} - \mu^2\right) \int_c^{c'} \rho \frac{de}{dc} dc. \end{aligned}$$

If we now replace  $r$  by its value  $c, \{1 + e, (\frac{1}{3} - \mu^2)\}$ , we get

$$V = \frac{4\pi}{c'} \int_0^{c'} \rho c^2 dc + 4\pi \int_c^{c'} \rho c dc + 4\pi \left(\frac{1}{3} - \mu^2\right) U, \quad (6)$$

where

$$U = -\frac{e'}{c'} \int_0^{c'} \rho c^2 dc + \frac{1}{5c'^3} \int_0^{c'} \rho \frac{d(ec^5)}{dc} dc + \frac{c'^2}{5} \int_c^{c'} \rho \frac{de}{dc} dc.$$

The first two integrals in (6) express the potential of a sphere whose density is a function of the distance from the centre, at an internal point: the quantity  $U$  is of the order of magnitude of  $e$ .

## 6.

It is proved in treatises on hydrostatics that if  $p$  be the pressure,  $\rho$  the density, and  $X, Y, Z$  the components of the force acting at the point  $xyz$  of a fluid mass

$$dp = \rho(Xdx + Ydy + Zdz),$$

and that for equilibrium it is necessary that the right hand member of this equation be a perfect differential, and that at the free surface

$$Xdx + Ydy + Zdz = 0;$$

this last condition requires the resultant force at each point of the surface to be normal to the surface. In a homogeneous fluid this is obviously the differential equation of all surfaces of equal pressure. If the fluid be heterogeneous, then it is to be remarked that if  $X, Y, Z$  be the components of the attraction of a mass whose potential is  $V$ ,

$$X = \frac{dV}{dx}, \quad Y = \frac{dV}{dy}, \quad Z = \frac{dV}{dz};$$

so that in this case  $Xdx + Ydy + Zdz$  is a complete differential. And in the case of a fluid rotating, say round the axis of  $z$ , with uniform velocity, the corresponding part of

$$Xdx + Ydy + Zdz$$

is easily seen to be a complete differential. Therefore, for the forces with which we are concerned, namely, attraction of gravitation and the so-called centrifugal force

$$Xdx + Ydy + Zdz = d\Theta,$$

where  $\Theta$  is some function of  $xyz$ , and it is necessary for equilibrium that  $dp = \rho d\Theta$  be a complete differential, that is,  $\rho$  must be a function of  $\Theta$ , so also  $p$  becomes a function of  $\Theta$ , so that  $d\Theta = 0$  is the differential equation of surfaces of equal pressure and equal density.

Although, since the earth is revolving about its axis, all problems relating to the relative equilibrium of the earth itself and the bodies on its surface are really dynamical problems, yet they may be treated statically by introducing in addition to the attraction the fictitious force called centrifugal force. Let the earth be referred to rectangular coordinates, the axis of  $z$  being that of revolution.



At the point  $xyz$  within the mass let  $V$  be the potential of the mass, then the components of the force there are

$$X = \frac{dV}{dx} + x\omega^2, \quad Y = \frac{dV}{dy} + y\omega^2, \quad Z = \frac{dV}{dz},$$

$\omega$  being the angular velocity of rotation. Then according to what precedes, at every surface of equal pressure and density

$$\frac{dV}{dx} dx + \frac{dV}{dy} dy + \frac{dV}{dz} dz + \omega^2 (x dx + y dy) = 0;$$

and integrating

$$\int \frac{d\rho}{\rho} = V + \frac{\omega^2}{2} (x^2 + y^2) = \Theta, \quad (7)$$

where  $\Theta$  is constant for a particular surface, but varies from one surface to another. This equation then is that of a surface of equal pressure and density; generally termed a level-surface. At every point of a level-surface the resultant force is perpendicular to the surface, and its amount is evidently  $\frac{d\Theta}{dn}$ , where  $dn$  is the element of the normal.

## 7.

Let us now enquire whether it is possible for a homogeneous fluid mass of the form of an ellipsoid, rotating round one of its axes, to be in relative equilibrium. If the semi-axes be  $abc$ , and  $fgh$  the coordinates of any particle of the mass, then the potential at this point is given by equation (2). If we substitute this value of  $V$  in the equation of a level-surface, and then divide by  $\frac{2}{3}M$ , where  $M$  is the mass of the ellipsoid, we get, supposing the axis  $c$  to be that of revolution,

$$-f^2 \int_0^\infty \frac{dt}{Q(a^2+t)} - g^2 \int_0^\infty \frac{dt}{Q(b^2+t)} - h^2 \int_0^\infty \frac{dt}{Q(c^2+t)} + \frac{2\omega^2}{3M} (f^2 + g^2) = C',$$

where  $Q^2 = (a^2+t)(b^2+t)(c^2+t)$ , and  $C'$  is a constant. This equation must hold at the external surface which is that of zero pressure: but at this surface

$$\frac{f^2}{a^2} + \frac{g^2}{b^2} + \frac{h^2}{c^2} = 1;$$

and comparing coefficients of  $f^2, g^2, h^2$ , we have

$$\begin{aligned}\frac{2\omega^2}{3M} - \int \frac{dt}{Q(a^2+t)} &= \frac{\mu}{a^2}, \\ \frac{2\omega^2}{3M} - \int \frac{dt}{Q(b^2+t)} &= \frac{\mu}{b^2}, \\ - \int \frac{dt}{Q(c^2+t)} &= \frac{\mu}{c^2},\end{aligned}$$

which are equivalent to two equations; and we have to ascertain whether the results to which they point are possible. Subtract the second equation from the first and we get

$$a^2 b^2 \int \frac{(a^2 - b^2) dt}{Q(a^2+t)(b^2+t)} = \mu(b^2 - a^2);$$

then eliminating  $\mu$  by means of the third equation, the result is

$$(a^2 - b^2) \left\{ \int \frac{a^2 b^2 dt}{Q(a^2+t)(b^2+t)} - \int \frac{c^2 dt}{Q(c^2+t)} \right\} = 0;$$

this condition may be satisfied either by  $a = b$ , in which case the ellipsoid is one of revolution round  $c$ ; or by making the quantity within the brackets vanish, that is

$$\int_0^\infty \frac{(a^2 + b^2 - \frac{a^2 b^2}{c^2}) t + t^2}{Q^3} dt = 0;$$

but there can be no negative elements in this integral unless

$$c < \frac{ab}{(a^2 + b^2)^{\frac{1}{2}}}.$$

Imagine a triangle having two sides  $a, b$ , including a right angle, then the perpendicular from the right angle to the hypotenuse is  $ab(a^2 + b^2)^{-\frac{1}{2}}$ . From this it appears that  $c$  must be less than either  $b$  or  $a$  if the last-written integral is to vanish. If, however,  $c$  be very small the integral becomes negative. Therefore there is some value of  $c$  which will satisfy the equation. For a discussion of this very interesting problem see a paper in the *Proceedings of the Royal Society*, No. 123, 1870, by Mr. Todhunter.

That the value of  $\omega$  is real will appear from the first and third equations, which give

$$\frac{2\omega^2}{3M} = \frac{a^2 - c^2}{a^2} \int \frac{t dt}{Q(a^2+t)(c^2+t)},$$

which is essentially positive.

This remarkable fact, that a homogeneous fluid ellipsoid of three unequal axes, revolving about its smallest axis, can be in a state of relative equilibrium, was discovered by Jacobi in 1834.

## 8.

In the case in which  $a = b$  and the ellipsoid becomes an oblate spheroid, there is but one equation of condition, namely, that which connects the velocity of rotation with the ratio of the axes. Let the axes be  $c$  and  $c(1 + \epsilon^2)^{\frac{1}{2}}$ ; then if  $\rho$  be the density of the fluid mass, the last equation written down becomes

$$\frac{\omega^2}{2\pi\rho} = c^3 \epsilon^2 \int_0^\infty \frac{t dt}{Q(a^2 + t)(c^2 + t)}.$$

Now transform this integral by putting  $c^2 + t = \epsilon^2 c^2 \cot^2 \theta$ , then  $Q = \epsilon^3 c^3 \cot \theta \operatorname{cosec}^2 \theta$ , and

$$\begin{aligned} \frac{dt}{Q} &= -\frac{2 d\theta}{\epsilon c}; \\ \therefore \frac{\omega^2}{2\pi\rho} &= \frac{2}{\epsilon^3} \int_0^{\tan^{-1}\epsilon} (\epsilon^2 - \tan^2 \theta) \sin^2 \theta d\theta \\ &= \frac{3 + \epsilon^2}{\epsilon^3} \tan^{-1} \epsilon - \frac{3}{\epsilon^2}. \end{aligned}$$

Suppose  $\epsilon$  to take consecutively all values from 0 to  $\infty$ ; call the right-hand member of the last equation  $E$ ; then as  $\epsilon$  increases from zero,  $E$  increases from zero until, for a certain value of  $\epsilon$  derived from the equation  $dE = 0$ , or

$$\tan^{-1} \epsilon = \frac{9\epsilon + 7\epsilon^3}{(1 + \epsilon^2)(9 + \epsilon^2)},$$

$E$  becomes a maximum. As  $\epsilon$  increases from this value, which is about 2.5, to infinity,  $E$  gradually diminishes to zero; there is therefore a maximum limit to  $\omega$ , and when the angular velocity is less than this limit, there are always two spheroids which satisfy the conditions of equilibrium: in one  $\epsilon$  is greater, and in the other less than 2.5. This fact was first indicated by Thomas Simpson, and subsequently proved by D'Alembert. It is to be remarked, however, that the same mass of fluid cannot take indifferently one or other of these

without an alteration in its moment of momentum. If the moment of momentum and the mass be given, there is but one possible form of equilibrium.

We may now shew that the earth cannot be or have been a homogeneous fluid. If  $\rho$  be the mean density of the earth, its mass is  $\frac{4}{3}\pi\rho a^3$ , where  $a$  is the radius of the equator, and this mass divided by  $ac$  may be taken as the mean amount of the attraction at the surface; then, if  $m$  be the ratio of centrifugal force at the equator to gravity,

$$m = \frac{a\omega^2}{\frac{4}{3}\pi\rho a}; \quad \therefore \frac{\omega^2}{2\pi\rho} = \frac{3}{4}m.$$

Let  $l$  be the length of the seconds pendulum, then the acceleration due to gravity is  $\pi^2 l$ : at the equator,  $l = 39.017$  inches; at the pole,  $l = 39.217$ ; the mean of these is the length of the seconds pendulum in the latitude of  $45^\circ$ . Also, the acceleration due to centrifugal force is, if  $t$  be the number of mean solar seconds corresponding to one revolution of the earth,

$$a\omega^2 = \frac{4a\pi^2}{t^2};$$

hence on substituting the values  $t = 86164$  and  $a = 20926000$  feet,  $l = 39.117$  inches,

$$m = \frac{4a}{l t^2} = \frac{1}{289.1}.$$

Now when  $\epsilon^2$  is very small, as in the case we are considering,

$$\frac{\omega^2}{2\pi\rho} = \frac{3 + \epsilon^2}{\epsilon^3} \tan^{-1} \epsilon - \frac{3}{\epsilon^2} = \frac{4}{15} \epsilon^2;$$

and this we have seen to be equal to  $\frac{3}{4}m$ , hence

$$\frac{1}{2} \epsilon^2 = \frac{5}{4} m;$$

and the ratio of the axes being  $1 : 1 + \frac{1}{2}\epsilon^2$ , is  $231.3 : 232.3$ , which differs materially from what we know to be the actual ratio.

## 9.

Let us now consider the case of a revolving fluid spheroid which is not of uniform density. Without assuming any law

for the density, let it be so far limited as that the surfaces of equal density shall be spheroids concentric and coaxial with the surface, and then determine the conditions which make equilibrium possible. In this case the surfaces of equal density are also surfaces of equal pressure. The potential at any point of such a mass is given in (6), and this has to be substituted in (7), which may be conveniently put in the form

$$\Theta = V + \frac{\omega^2}{2} r^2 (1 - \mu^2) = V + \frac{1}{3} r^2 \omega^2 + \frac{1}{2} r^2 \omega^2 (\frac{1}{3} - \mu^2). \quad (8)$$

To conform with previous notation,  $r$  is to be here replaced by  $c$ , since small quantities of the second order are excluded. The result of the substitution is, if  $4\pi U + \frac{1}{2} c'^2 \omega^2 = \Omega$ ,

$$\int \frac{dp}{\rho} = \frac{4\pi}{c'} \int_0^{c'} \rho c^2 dc + 4\pi \int_{c'}^c \rho c dc + \frac{1}{3} c'^2 \omega^2 + (\frac{1}{3} - \mu^2) \Omega.$$

Now this is to be constant for the spheroidal surface defined by  $c$ , and  $e$ , but in order that it may be so,  $\Omega$  must vanish: hence, restoring the value of  $U$  from (6),

$$\int \frac{dp}{\rho} = \frac{4\pi}{c'} \int_0^{c'} \rho c^2 dc + 4\pi \int_{c'}^c \rho c dc + \frac{1}{3} c'^2 \omega^2 \quad (9)$$

and

$$- \frac{e'}{c'} \int_0^{c'} \rho c^2 dc + \frac{1}{5c'^3} \int_0^{c'} \rho \frac{d(ec^5)}{dc} dc + \frac{c'^2}{5} \int_{c'}^c \rho \frac{de}{dc} dc + \frac{c'^2 \omega^2}{8\pi} = 0. \quad (10)$$

This very important equation, expressing the condition of equilibrium, was first given by Clairaut<sup>1</sup>. He transforms it thus: omitting the subscripts which specified the particular surface at which the potential was taken,—multiply (10) by  $c^3$ ; differentiate and divide by  $c^4$ ; differentiate again, and then multiplying by  $c^2$ , the result may be written

$$\frac{d^2 e}{dc^2} + \frac{2\rho c^2}{\phi(c)} \cdot \frac{de}{dc} + \left( \frac{2\rho c}{\phi(c)} - \frac{6}{c^2} \right) e = 0, \quad (11)$$

where  $\phi(c)$  is written for  $\int_0^c \rho c^2 dc$ .

<sup>1</sup> See *Théorie de la figure de la Terre*, &c., pp. 273, 276.

## 10.

The differential equation just arrived at can always be integrated, at least by series, when  $\rho$  is given in terms of  $c$ ; and the two arbitrary constants will enable us to make the value of  $e$  satisfy the equation from which it is derived. When therefore  $\rho$  is given in terms of  $c$  it is always possible to find the ellipticity of every surface of equal density and pressure so as to satisfy the condition of equilibrium. Thus we have a possible constitution for the earth. Without however assigning any particular law of density, Clairaut made a very important deduction from the preceding; it may be put thus: the mass  $M$  of the spheroid is  $= 4\pi\phi(c')$ , and the ratio of centrifugal force at the equator to gravity being  $m = c'^3 \omega^2 : M$ ,

$$\frac{c'^3 \omega^2}{8\pi} = \frac{m}{2c'} \phi(c').$$

In (10) make  $c = c'$ ; the result is

$$\frac{1}{5c'^2} \int_0^{c'} \frac{d}{dc} (ec^5) dc - \left(c' - \frac{m}{2}\right) \phi(c') = 0; \quad (12)$$

then (5) gives for the potential at any point external to the earth

$$V = \frac{M}{r} + \frac{M}{r^3} c'^2 \left(c' - \frac{m}{2}\right) \left(\frac{1}{3} - \mu^2\right). \quad (13)$$

If we differentiate this with respect to  $r$ , the differential coefficient taken with a negative sign gives the attraction in the direction of the earth's centre, which may be taken for the component in the direction of the normal as we are neglecting small quantities of the second order. In order to get the whole force of gravity which includes centrifugal force we must add to this the vertical component of the latter. Or, more directly, the value of  $g$  is

$$g = -\frac{d\Theta}{dr} = -\frac{dV}{dr} - r\omega^2(1 - \mu^2).$$

Performing the differentiation, and putting for  $r$  its value at the surface, the result is

$$g = \frac{M}{c'^2} \left\{ 1 - \frac{1}{3}m + \left(c' - \frac{5}{2}m\right) \left(\frac{1}{3} - \mu^2\right) \right\}.$$

Let  $G$  be the value of gravity at the equator, where  $\mu = 0$ ; then if  $\phi$  be the latitude,

$$g = G \left\{ 1 + \left( \frac{5}{2} m - e' \right) \sin^2 \phi \right\}. \quad (14)$$

Hence, the formula known as Clairaut's Theorem: viz. if  $G$ ,  $G'$  be the values of gravity at the equator and at the pole respectively, then

$$\frac{G' - G}{G} = \frac{5}{2} m - e'.$$

In his demonstration, Clairaut makes no assumption of original fluidity; he supposes the strata to be concentric and coaxial spheroidal shells, the density varying from stratum to stratum in any manner whatever: it is assumed however that the superficial stratum has the same form as if it were fluid, and in relative equilibrium when rotating with uniform angular velocity. Professor Stokes in his demonstration of Clairaut's Theorem in two papers<sup>1</sup> published in 1849, showed that if the surface be a spheroid of equilibrium of small ellipticity, Clairaut's Theorem follows independently of the adoption of the hypothesis of original fluidity or even of that of any internal arrangement in nearly spherical strata of uniform density. On this point it is needful to bear in mind that without altering gravity at any point on the surface of the earth, the internal arrangement of density may be altered in an infinity of ways: for since the attraction of a solid homogeneous sphere is at any external point equal to that of any concentric spherical shell of the same mass as the sphere—being homogeneous and not inclosing the point referred to—it is clear that one might leave a large cavity at any part of the earth's mass by distributing the matter in concentric shells outside it. The fact that the variations of gravity on the earth's surface, as indicated by the pendulum, are in accordance with the law shown in Clairaut's Theorem is therefore no evidence of the original fluidity of the earth.

## II.

In order to determine the law of ellipticity of the surfaces of equal density, it is necessary to assume some law con-

<sup>1</sup> *Cambridge and Dublin Mathematical Journal*, Vol. IV, page 194. *Cambridge Philosophical Transactions*, Vol. VIII, page 672.

necting  $\rho$  with  $c$ . The law assumed by Laplace, and not since replaced by any better hypothesis is, that the compressibility of the matter of which the earth consists is such that the increase of the square of the density is proportional to the increase of pressure. This law involves at least nothing at variance with our experimental knowledge of the compressibility of matter. Expressed symbolically, it is

$$\begin{aligned} dp &= k\rho dc, \\ \therefore \int \frac{dp}{\rho} &= k\rho + C. \end{aligned}$$

Now, by (9), if we omit the small term in  $\omega^2$  and replace  $h$  by  $4\pi k^2$ —an arbitrary constant, the equation becomes

$$C + k^2 \rho = \frac{1}{c} \int_0^c \rho c^2 dc + \int_c^{c'} \rho c dc.$$

Multiply this by  $c$  and differentiate twice, thus

$$\frac{d^2}{dc^2}(\rho c) + \frac{\rho c}{k^2} = 0.$$

of which the integral is

$$\rho c = h \sin\left(\frac{c}{k} + g\right).$$

Now, in order that the density at the centre may not be infinite, it is necessary that  $g = 0$ : this gives for the law of density

$$\rho = \frac{h}{c} \sin \frac{c}{k}.$$

We may obtain the mean density  $\rho_0$  of the earth thus: the mass of the spheroid is

$$\begin{aligned} 4\pi \phi(c') &= \frac{4}{3} \pi \rho_0 c'^3; \\ \therefore \rho_0 &= \frac{3}{c'^3} \phi(c'). \end{aligned}$$

But

$$\begin{aligned} \phi(c) &= \int_0^c c h \sin \frac{c}{k} dc, \\ &= -c h k \cos \frac{c}{k} + h k \int_0^c \cos \frac{c}{k} dc, \\ &= h k \left( k \sin \frac{c}{k} - c \cos \frac{c}{k} \right); \\ \therefore \rho_0 &= 3 \frac{h k}{c'^2} \left\{ \frac{k}{c'} \sin \frac{c'}{k} - \cos \frac{c'}{k} \right\}. \end{aligned}$$



If  $\rho'$  be the surface density,

$$\rho' = \frac{h}{c'} \sin \frac{c'}{k}.$$

Now make the following substitutions: let the ratio of the surface density to the mean density be  $n$ , that is  $\rho' = n\rho_0$ , and put  $c' = k\theta$ , then we have

$$\frac{1}{n} = \frac{3}{\theta^2} - \frac{3}{\theta \tan \theta}. \quad (15)$$

## 12.

With Laplace's law of density we can now solve equation (11). Differentiate the expression for  $\rho$ , and the result is

$$\frac{d\rho}{dc} = \frac{h}{kc} \cos \frac{c}{k} - \frac{h}{c^2} \sin \frac{c}{k} = -\frac{\phi(c)}{k^2 c^2},$$

and substituting this in the equation referred to, it may without difficulty be transformed to this—

$$\frac{d^2}{dc^2} (\phi(c)e) + \left(\frac{1}{k^2} - \frac{6}{c^2}\right) (\phi(c)e) = 0,$$

of which the integral<sup>1</sup> is

$$e\phi(c) = C \left\{ \left(1 - \frac{3k^2}{c^2}\right) \sin\left(\frac{c}{k} + B\right) + \frac{3k}{c} \cos\left(\frac{c}{k} + B\right) \right\}.$$

Here  $B$  must be zero, or the ellipticity at the centre would be infinite, as may be seen on expanding  $e$  in powers of  $c$ . We may put this result in the form

$$e\phi(c) = C \left\{ c\rho - \frac{3}{c^2} \phi(c) \right\}, \quad (16)$$

which gives for any stratum

$$e = \frac{3C}{c^2} \left\{ \frac{1}{3 \frac{k^2}{c^2} \left(1 - \frac{c}{k} \cot \frac{c}{k}\right)} - 1 \right\}.$$

At the surface this becomes

$$e' = \frac{3C}{c'^2} (n-1).$$

<sup>1</sup> See Boole's *Differential Equations*, 3rd edition, page 425.

and at the centre where  $c = 0$

$$e_0 = \frac{\rho'}{15} \cdot \frac{\theta^2}{1-n}.$$

So far, the law of ellipticity of the strata is determined, but not the ellipticity of the surface absolutely. That may be arrived at in terms of  $n$  by the following process. We have seen that

$$5\rho'^2 \left(\rho' - \frac{m}{2}\right) \phi(\rho') = \int_0^{\rho'} \rho \frac{d}{dc} (e c^5) dc;$$

call this  $\phi_1(\rho')$ : then remembering that  $3n\phi(\rho') = \rho' c'^3$ ,

$$\rho' - \frac{m}{2} = \frac{3n\phi_1(\rho')}{5\rho' c'^5}. \quad (17)$$

Integrate by parts, taking into account (15), thus

$$\phi_1(\rho') = \rho' c' c'^5 + \frac{1}{k^2} \int_0^{\rho'} c^3 e \phi(c) dc,$$

substitute the value of  $e\phi(c)$  obtained above, (16), and make use of the equations  $c' = k\theta$ ,  $c'\rho' = h \sin \theta$ , then we find

$$\int e c^3 \phi(c) dc = \rho' c'^3 \frac{C k^2}{\theta^2} \{6\theta^2 - 15 + (15\theta - \theta^3) \cot \theta\};$$

but  $\rho' c'^2 = 3(n-1)C$ , as we have seen, therefore

$$\frac{1}{k^2} \int e c^3 \phi(c) dc = \frac{\rho' c' c'^5}{n-1} \left\{ \frac{\theta^2}{9n} + \frac{5}{3} - \frac{5}{3n} \right\};$$

therefore

$$\phi_1(\rho') = \frac{\rho' c' c'^5}{n} \left\{ \frac{5}{3} + n - \frac{1}{9} \frac{\theta^2}{1-n} \right\};$$

substitute this in (17), and we find

$$\frac{5m}{6\rho'} = \frac{1}{9} \cdot \frac{\theta^2}{1-n} - n. \quad (18)$$

Thus, the ellipticity of the surface is expressed in terms of the ratio of the mean density to the surface density.

### 13.

Supposing the earth to have become solidified in the fluid form of equilibrium with the law of density we have been considering, there is a test of the preceding theory to be found in the phenomenon of the precession of the equinoxes; astronomical observations giving a very exact value of  $(C-A):C$

where  $A$  and  $C$  are the principal moments of inertia of the mass. The principal moments of inertia of a homogeneous spheroid whose density is  $\rho$  and semiaxes  $c(1 - \frac{2}{3}e)$ ,  $c(1 + \frac{2}{3}e)$  are

$$\begin{aligned} A' &= \frac{2}{3} c^2 M (1 - \frac{2}{3} e), \\ C' &= \frac{2}{3} c^2 M (1 + \frac{2}{3} e). \end{aligned}$$

So that for the spheroid representing the earth,

$$\begin{aligned} C - A &= \frac{8\pi}{15} \phi_1(c'), \\ C &= \frac{8\pi}{3} \int_0^{c'} \rho c^4 dc. \end{aligned}$$

It is unnecessary to retain quantities of the order  $e$  in  $C$ . Now

$$\begin{aligned} \int_0^{c'} \rho c^4 dc &= h k^4 \int_0^{c'} \frac{c^3}{k^3} \sin \frac{c}{k} d\left(\frac{c}{k}\right), \\ &= \frac{k^4 c' \rho' \theta^2}{n} \left(\frac{\theta^2}{3} + 2n - 2\right), \\ &= \frac{c'^5 \rho'}{3n} \left(1 + 6 \frac{n-1}{\theta^2}\right); \end{aligned}$$

but

$$\begin{aligned} C - A &= \frac{8\pi}{15} \phi_1(c') = \frac{8\pi}{3} \left(c' - \frac{m}{2}\right) \cdot \frac{c'^5 \rho'}{3n}, \\ \therefore \frac{C - A}{C} &= \frac{c' - \frac{m}{2}}{1 - 6 \frac{1-n}{\theta^2}}, \end{aligned} \tag{19}$$

which is another remarkably simple result following from Laplace's law of density, and enables us from the observed constant of precession to deduce a value of the earth's ellipticity. This method was first pointed out by d'Alembert in his work, *Recherches sur la Précession des Équinoxes*.

#### 14.

In the following table we give the numerical results of the preceding theory on six different suppositions as to the magnitude of the ratio of the mean density to the superficial density of the earth. The second column gives the value of

the subsidiary angle  $\theta$  in arc, which is expressed in degrees in the next column; the fourth column gives the ellipticity of the surface; the next that of the strata at the earth's centre; the last column gives the computed constant of precession:—

$\frac{1}{n}$	$\theta$	$\frac{\theta}{\pi} \cdot 180^\circ$	$e'$	$e_0$	$\frac{C-A}{C}$
1.9	2.4083	138.0°	$\frac{1}{289.4}$	$\frac{1}{354}$	$\frac{1}{295}$
2.0	2.4605	141.0°	$\frac{1}{293.2}$	$\frac{1}{363}$	$\frac{1}{300}$
2.1	2.5058	143.6°	$\frac{1}{296.9}$	$\frac{1}{371}$	$\frac{1}{305}$
2.2	2.5454	145.8°	$\frac{1}{300.2}$	$\frac{1}{379}$	$\frac{1}{309}$
2.3	2.5804	147.8°	$\frac{1}{303.2}$	$\frac{1}{386}$	$\frac{1}{312}$
2.4	2.6115	149.6°	$\frac{1}{306.1}$	$\frac{1}{393}$	$\frac{1}{316}$

The actual value of  $C-A:C$  determined from astronomical observations (*Annales de l'Observatoire Impérial de Paris*, tome V. 1859, page 324) is between  $\frac{1}{310.8}$  and  $\frac{1}{310.8}$ , which corresponds with the value of  $n = \frac{1}{2.1}$ . As we shall see in the sequel the value of  $n = \frac{1}{2}$  is that which corresponds to the ellipticity  $\frac{1}{310.8}$  of the earth as derived from the measured arcs of meridian. The results of pendulum observations have been supposed to give, by means of Clairaut's Theorem, an ellipticity of about  $\frac{1}{310.8}$ , which corresponds with  $n = \frac{1}{1.9}$ . We shall see, in a subsequent chapter, the bearing of recent observations in India on this point.

## 15.

That the agreement indicated in the last paragraph between the results of the preceding theory and the results of observation and measurements is not more exact need not surprise us.

The substance of the earth is not of the nature supposed in the theory; that it was at one time entirely fluid is almost certain, but at present the crust at least is solid to a depth of many miles, and the whole visible surface is most irregular, presenting oceans, continents, and mountains. The surface which has to be compared with theory is that of the ocean continued in imagination to percolate by canals the continents: this surface, represented always by the mean height of the sea, is what we understand by the mathematical surface of the earth. The irregular and unsymmetrical forms of oceans and continents forbids us to suppose that the form of the sea is any regular surface of revolution, and this irregularity must produce a discordance between the fluid theory and the results of measurements. Every mountain mass we assume to produce some disturbance of the mathematical surface, and any variation of density in the underlying portions of the crust will do the same. Having seen that the general figure of the earth is very fairly in accordance with theory, we shall now examine into the irregularities of the surface caused by disturbing masses, and in so doing, we may simplify matters by neglecting the earth's ellipticity and rotation, and consider it a sphere whose density, except near the surface, is a function of the distance from the centre. Suppose then, in the first instance, the earth to be such a symmetrical sphere covered with a thin film of sea, its radius =  $c$ ; let matter  $m$  be now added all over and throughout the crust, of varying positive or negative density  $\zeta$ , a function of the latitude and longitude, in such a manner as to represent the actual state of the earth's superficial density and inequalities. The total amount of the disturbing matter  $m$  is to be zero. Now take any point  $P$  on the surface of the no longer spherical sea, let  $y+c$  be the distance of  $P$  from the earth's centre, and let the potential at  $P$  of the mass  $m$  be  $V$ . Then the surface of the sea being an equipotential surface must be represented when the constant is properly determined by the equation

$$V + \frac{M}{c+y} = \frac{M}{c} - \text{constant.}$$

where  $M$  is the mass of the earth. Since  $y$  is very small, we

shall omit its square, thus

$$\frac{M}{c^2} y = V + \text{constant},$$

$$\therefore y = \frac{c^2}{M} V + C. \tag{20}$$

Here  $C$  is to be determined so that

$$\iint y \sin \theta \, d\theta \, d\phi,$$

taken over the whole spherical surface, may be zero. Let us now, since it is impossible to assign any general form to  $V$  in the equation just deduced, suppose the case of the disturbing mass being restricted to a certain locality. We shall suppose it to be a mass of great density and of such compact form that its potential shall be the same, or very nearly the same, as if the whole were gathered into its centre; which is supposed, moreover, to be below the surface of the ground.

Let  $\mu M$  be the mass,  $kc$  the depth of its centre below the surface. Let  $\theta$  be the angle between the radius drawn through  $m$ , the centre of the disturbing mass, and that drawn to  $P$  a point on the disturbed surface. Let  $p$  be the projection of  $P$  on the spherical surface, then since  $Pp$  is very small, we may put  $V = \mu M \div mp$ , and if  $mO = kc$ ,

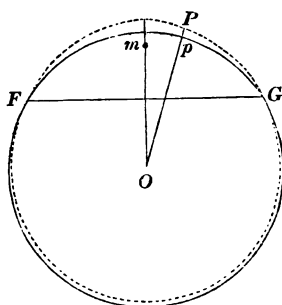

Fig. 13.

$$y = \frac{\mu c}{(1 + k^2 - 2k \cos \theta)^{\frac{1}{2}}} + C,$$

will be the equation of the curve which by revolution round  $mO$  generates the disturbed surface. The volume contained by this surface will be equal to that of a sphere of radius  $c$  if we make

$$\int_0^\pi y \sin \theta \, d\theta = 0,$$

or,

$$\int_0^\pi \frac{\mu c \sin \theta \, d\theta}{(1 + k^2 - 2k \cos \theta)^{\frac{1}{2}}} + 2C = 0;$$

$$\therefore \left[ \frac{\mu c}{k} (1 + k^2 - 2k \cos \theta)^{\frac{1}{2}} \right]_0^\pi + 2C = 0;$$

hence  $C + \mu c = 0$ , and,

$$y = \mu c \left\{ \frac{1}{(1 + k^2 - 2k \cos \theta)^{\frac{1}{2}}} - 1 \right\}:$$

expresses the elevation of the disturbed surface at every point.

It will be seen that if we draw  $FG$  bisecting  $mO$  at right angles, then  $y$  is positive for all those points which are on the same side of  $FG$  with the point  $m$ , and negative at all other places. The maximum value of  $y$  corresponds to  $\theta = 0$ , showing that the greatest elevation takes place directly over the disturbing mass. This maximum elevation is, neglecting  $h^2$ ,

$$Y = \frac{\mu c}{h}.$$

In order to get some definite numerical ideas from the result at which we have just arrived, let the disturbing mass be a sphere of radius =  $n$  miles, its centre being at the same distance  $n$  below the surface. Let its density,—being that by which it is in excess of the normal density in its vicinity—be half the mean density of the earth, then

$$\mu = \frac{1}{2} \left( \frac{n}{c} \right)^3 = \frac{1}{2} h^3,$$

$$Y = \frac{n^2}{2c}.$$

Here  $Y$  is expressed in miles: to express it in feet we must multiply this by 5280, also put  $c = 3960$ ; thus in feet

$$Y = \frac{2}{3} n^2.$$

If then the diameter of the sphere of disturbing matter be one mile,  $n = \frac{1}{2}$ , and the value of  $Y$  is two inches. This shows that a large disturbing mass may produce but a very small disturbance of the sea-level—whether indeed the mass be situated above or below the surface. A displacement of the sea-level, such as has just been supposed, could not make itself directly perceptible in geodetic operations, but indirectly it can, viz. through the inclination of the disturbed surface to the spherical undisturbed surface, or which is much the same, by means of the altered curvature of the surface: for careful geodetic operations enable one to assign the local curvature of the surface with considerable precision.

## 16.

Let us confine our attention to the surface in the vicinity of the disturbance, and thus disregard powers of  $\theta$  higher than the square, then the equation of the generating curve is

$$r = c + \frac{\mu c}{(h^2 + \theta^2)^{\frac{1}{2}}} - \mu c,$$

of which the part  $\mu c$  may be dismissed from consideration being a very small constant. The angle between the surfaces—termed local deflection of the plumb-line—is

$$-\frac{dr}{cd\theta} = \frac{\mu\theta}{(h^2 + \theta^2)^{\frac{3}{2}}},$$

also, since

$$-\frac{d^2r}{cd^2\theta} = \frac{\mu(h^2 - 2\theta^2)}{(h^2 + \theta^2)^{\frac{5}{2}}},$$

the greatest local deflection corresponds to

$$\theta = \frac{1}{\sqrt{2}}h,$$

that is, it is found at a point on the surface whose distance from the radius of the earth passing through the centre of the disturbing mass is to the depth of that centre as  $1:\sqrt{2}$ . The maximum deflection  $\psi$  then has the value

$$\psi = \frac{2\mu}{3h^2\sqrt{3}}.$$

Taking the same disturbing mass as before, that is to say, with a radius of  $n$  miles, this becomes in arc

$$\psi = \frac{n}{3c\sqrt{3}},$$

or expressed in seconds

$$\psi = \frac{n \times 180.60.60}{3960 \pi.3\sqrt{3}} = \frac{200\sqrt{3}}{11\pi} n,$$

which is almost exactly  $10n$ . Taking  $n$  as in the previous case =  $\frac{1}{2}$ ,  $\psi = 5''.0$ . Now this in geodetic measurements is a large quantity, that is to say, that with ordinary care, one can determine the latitude of a place to half a second, so that



5'' would be a very measurable quantity. Then if we consider two points which lie on opposite sides at the distance  $\pm c h \sqrt{\frac{3}{2}}$  from that point of the surface which is vertically over the disturbing mass, the angle between the normals to the disturbed surface at those points will be larger than the angle between the corresponding normals of the spherical surface by 10''. This leads us to consider the curvature of the surface in a plane section passing through the earth's centre and the disturbing mass. The radius of curvature  $R$  may be obtained from the known formula

$$\frac{1}{R} = \frac{r^2 + 2 \left( \frac{dr}{d\theta} \right)^2 - r \frac{d^2 r}{d\theta^2}}{\left( r^2 + \left( \frac{dr}{d\theta} \right)^2 \right)^{\frac{3}{2}}},$$

we may omit the square of  $\frac{dr}{d\theta}$ , and thus with sufficient precision

$$\begin{aligned} \frac{1}{R} &= \frac{1}{r} \left( 1 - \frac{1}{r} \frac{d^2 r}{d\theta^2} \right) \\ &= \frac{1}{c} \left\{ 1 - \mu \frac{2\theta^2 - h^2}{(h^2 + \theta^2)^{\frac{3}{2}}} \right\}. \end{aligned}$$

To determine the maximum and minimum values of the curvature, we must put the differential coefficient of  $R^{-1}$ , with respect to  $\theta$ , equal to zero: that is,  $\theta(2\theta^2 - 3h^2) = 0$ , which is satisfied either by  $\theta = 0$ , or  $\theta = h\sqrt{\frac{3}{2}}$ , the former corresponds to the maximum curvature which is found vertically over the disturbing mass, and is expressed by

$$\frac{1}{R_1} = \frac{1}{c} \left( 1 + \frac{\mu}{h^3} \right),$$

while the minimum curvature found at the distance  $c h \sqrt{\frac{3}{2}}$  is expressed by

$$\frac{1}{R_2} = \frac{1}{c} \left( 1 - \frac{8\sqrt{10}}{125} \cdot \frac{\mu}{h^3} \right).$$

Now whatever be the radius of the disturbing sphere, if the depth of its centre be equal to its radius, and the disturbing density be half the mean density of the earth, then

$\mu = \frac{1}{2} k^2$ , and the radii of the surface become changed in the positions indicated into

$$R_1 = \frac{2}{3} c, \quad R_2 = \frac{1}{9} c,$$

so that enormous variations of curvature result from even small disturbing masses below the surface. That effects of a similar character would follow in the case of compact disturbing masses above the surface, is easy to see.

17.

To take the case of a supposed mountain range, of which the slope is much more precipitous on one side than on the other; let us enquire into the difference of level of the disturbed surface of the sea at the foot of the one slope as compared with that at the other. Strictly speaking, the level will be one and the same, but there will be a difference with reference to the undisturbed spherical surface. For simplicity, suppose the range to be of a uniform triangular section as in the accompanying diagram: let  $s$ ,  $s'$  be the lengths of the slopes,  $\sigma$ ,  $\sigma'$  their inclinations. We shall suppose that the breadth of the base  $SS' = a$ , is

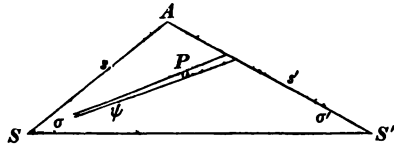

Fig. 14.

considerably less than the length of the range. To determine the potential of the mass at the middle of its length and at the foot  $S$  of the slope, let it be divided by planes passing through the edge  $S$  of the prism as indicated in the figure, and these slices into elementary prisms as indicated at  $P$ . Let  $PSS' = \psi$ ,  $SP = r$ , and let  $x$  be the distance of any point in this elementary prism from its centre, then the element of mass to unit density is  $r d\psi dr dx$ , and

$$V = 2 \int_0^\sigma \int_0^r \int_0^k \frac{r d\psi dr dx}{(r^2 + x^2)^{\frac{1}{2}}},$$

where  $2k$  is the length of the range. After the  $x$  integration we may—omitting terms depending on  $r^2 : k^2$ —substitute

$$\log \frac{2k}{r} \text{ for } \log \left\{ \frac{k}{r} + \left( \frac{k^2}{r^2} + 1 \right)^{\frac{1}{2}} \right\},$$

thus

$$\begin{aligned} V &= 2 \int_0^\sigma \int_0^r r \log \frac{2k}{r} d\psi dr \\ &= a^2 \int_0^\sigma \sin^2 \sigma' \left\{ \operatorname{cosec}^2 (\sigma' + \psi) \log \frac{2k \sin (\sigma' + \psi)}{a \sin \sigma'} \right. \\ &\quad \left. + \frac{1}{2} \operatorname{cosec}^2 (\sigma' + \psi) \right\} d\psi; \end{aligned}$$

the result of this integration gives

$$\frac{V}{2\Delta} = \frac{3}{2} + \log \frac{2k}{a} + \frac{s}{s'} \cos A \log \frac{a}{s} - \frac{s}{s'} \sin A \cdot \sigma,$$

where  $\Delta$  is the area of the triangular section. Similarly at  $S'$

$$\frac{V'}{2\Delta} = \frac{3}{2} + \log \frac{2k}{a} + \frac{s'}{s} \cos A \log \frac{a}{s'} - \frac{s'}{s} \sin A \cdot \sigma'.$$

In taking the difference,  $k$  is eliminated, thus

$$\begin{aligned} \frac{V-V'}{2\Delta} &= \\ &= -\cos(\sigma + \sigma') \left\{ \frac{s}{s'} \log \frac{a}{s} - \frac{s'}{s} \log \frac{a}{s'} \right\} + \sin(\sigma' + \sigma) \left\{ \frac{s'\sigma'}{s} - \frac{s\sigma}{s'} \right\}. \end{aligned}$$

Now according to the formula (20) we have already investigated, the elevation of the disturbed surface at  $S$ , above that at  $S'$  is

$$y - y' = \frac{c^2}{M} (V - V');$$

put here  $c = 3960$  miles, and let the ratio of the density of the mountains to that of the earth be  $\frac{1}{2}$ , then, expressed in feet

$$y - y' = \frac{1}{2\pi} (V - V'). \quad (21)$$

Suppose, for example, that the base of the slope  $s$  is one mile in breadth, that of  $s'$  three miles, so that  $a = 4$ ; then the height being taken as one mile, the value of  $V - V'$  is  $+1.426$ : the surface of the sea therefore at  $S$  is further from the centre of the earth by 2.75 inches than it is at  $S'$ .

## 18.

Let us next consider the effect of an extended plateau or tract of country in elevating the surface of the sea along its

coast. The simplest case that can be taken is that in which the boundary of the tract in question is a small circle. Let  $E$  be the centre of this circle, its radius =  $a$ ,  $P$  any point of the surface within the circle, and  $F$  a fixed point on its circumference; let also  $EFP = \phi$ ,  $FP = \theta$ , and let  $\gamma$  be an angle, such that

$$\tan \frac{1}{2} \gamma = \tan a \cos \phi.$$

Let  $h$  be the height, supposed uniform, of the plateau, so that an element of mass at  $P$  is  $c^2 h \sin \theta d\phi d\theta$ , then  $h$  being taken as indefinitely small with respect to  $c$ , the potential at  $F$  is

$$\begin{aligned} V &= 2 \int_0^{\frac{1}{2}\pi} \int_0^\gamma c h \cos \frac{1}{2} \theta d\phi d\theta \\ &= 4 c h \int_0^{\frac{1}{2}\pi} \sin \frac{1}{2} \gamma d\phi \\ &= 4 c h \int_0^{\frac{1}{2}\pi} \frac{\sin a \cos \phi d\phi}{(1 - \sin^2 a \sin^2 \phi)^{\frac{1}{2}}} \\ &= 4 c h \left[ \sin^{-1} \sin a \sin \phi \right]_0^{\frac{1}{2}\pi} = 4 c h a. \end{aligned}$$

So also we may find that the potential at  $E$  is  $4 \pi c h \sin \frac{1}{2} a$ , while at the opposite point  $E'$  of the sphere it is

$$4 \pi c h (1 - \cos \frac{1}{2} a).$$

Then if, as in (21),  $y_0$ ,  $y$ ,  $y'$  be the elevations in feet of the sea at  $E$ ,  $F$ , and  $E'$  respectively, the density of the attracting region being half the mean density of the earth

$$y_0 = 2 c h \sin \frac{1}{2} a + C,$$

$$y = 2 c h \frac{a}{\pi} + C,$$

$$y' = 2 c h (1 - \cos \frac{1}{2} a) + C.$$

We cannot get  $C$  without integrating a general expression for  $V$  over the entire spherical surface, but we may approximate to it by considering that at  $E'$ ,  $y'$  must be negative, so that  $C$  is numerically a larger quantity than  $-4 c h \sin^2 \frac{1}{2} a$ . In the case of the compact disturbing mass, we saw that  $y$  vanished at about  $60^\circ$  distance, and if we take this as a guide

in the present instance, it is to be noted that the potential of the disturbing region ( $a$  being small) at  $60^\circ$  distance is about double the potential at  $180^\circ$  that is at  $E'$ . This would give  $C = -8c\bar{h} \sin^2 \frac{1}{2}a$ , so that at any point on the circular border of the plateau the elevation of the sea-level in feet is

$$y = 2c\bar{h} \left( \frac{a}{\pi} - 4 \sin^2 \frac{1}{2}a \right),$$

where  $c$  and  $\bar{h}$  are to be expressed in miles.

Now, to apply this very rough approximate calculation to an actual case, take the plateau of the Himalayas. The area on which these mountains stand, though not circular, is equivalent in extent to a circle of about  $5^\circ$  radius, and the height is about 15,000 feet: this gives  $y$  in round numbers 600 feet. This calculation then shows us that large tracts of country may produce great disturbances of the sea-level, but it is at least questionable whether in point of fact they do. The attraction of the Himalayas as deflecting the plumb-line at various places in India has been computed<sup>1</sup>, and it has been found that there is little correspondence between theory and observation, for the attraction of the Himalayas only makes itself perceptible to observation at places quite close to them. Hence it is to be inferred that there is some counteracting cause cancelling the attraction of the visible mass. In our entire ignorance of the manner in which the crust of the earth has arrived at its present form, one can do little more than invent hypotheses of greater or less probability to account for the apparently singular physical phenomenon here presented.

The first explanation offered was that of the Astronomer Royal, Sir George Airy (in the *Philosophical Transactions* for 1855, page 101): it is based on the assumption that the crust of the earth is thin. Suppose, for instance, the solid crust had a thickness of 10 miles, the interior of the earth being fluid. Now suppose a table-land 100 miles broad in its smallest horizontal dimension, and 2 miles high throughout

<sup>1</sup> See *A Treatise on Attractions, Laplace's Functions and the Figure of the Earth*, by J. H. Pratt, M.A., F.R.S., Archdeacon of Calcutta. Also papers by the same in the *Philosophical Transactions* for 1855, 1858, and 1871.

to be placed on the surface; will this mass be supported or break through the crust and sink partly into the fluid? In the adjoining figure, let  $abcd$  be part of the earth's crust,  $efg$  the table land, and suppose the rocks to be separated by vertical fissures as indicated by the dotted lines, and conceive these fissures to be

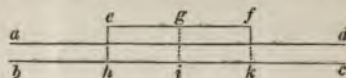

Fig. 15.

opened as they would be by a sinking of the middle of the mass, the two halves turning upon their lower points of connection with the rest of the crust. Let  $W$  be the weight of a cubic mile of the rock, and  $C$  the cohesion or force necessary to separate a square mile. Then the cohesion at  $h$  is  $10C$ , and at  $i$  it is  $12C$ ; also the superincumbent weight of each half is  $2 \times 50W$ , therefore considering one half only as  $eg$ , and taking moments  $10^2C + 12^2C = 2 \times 50^2W$ , so that  $C$  is about  $20W$ . That is, the cohesion would have to be sufficient to support a hanging column of 20 miles of rock. Had the thickness of the crust been assumed as a hundred miles, we should have had *ceteris paribus*  $C = \frac{1}{4}W$ . Even in this case the force of cohesion necessary is greater than can be supposed to exist, therefore the table land will not be supported by the crust. It appears then probable that such mountain masses must be accompanied with corresponding solid depressions as  $e'f'$ , or indentations into the fluid in order to preserve equilibrium. Now if we suppose

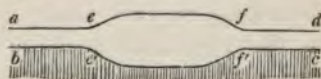

Fig. 16.

a station at  $a$ , there will be a deflection towards  $e$  owing to the attraction of the superincumbent matter  $ef$ , but the substitution of the lighter matter  $e'f'$  for the denser fluid matter, produces a negative attraction in the same direction. The diminution of attractive matter below will be sensibly equal to the increase of attracting matter above, and if the point  $a$  be not very near to  $ef$ , there may be no disturbance at all; but if  $a$  be close to the table land, and especially if the crust be anything like 100 miles thick, there will be a very sensible disturbance. The reasoning here applied to table lands does not apply of course to small compact mountain

masses such as Schiehallion or other isolated hills, or to small tracts of hilly country.

Archdeacon Pratt, as the result of his extensive calculations connected with the attraction of the Himalayas, not only as affecting by the horizontal component the direction of the vertical, but as affecting by the vertical component the oscillations of the pendulum in India, devised the theory that the variety seen in the elevations and depressions of the earth's surface, in mountains and plains, and ocean beds, has arisen from the mass having contracted unequally in becoming solid from a fluid or semifluid condition; and that under mountains and plains there is a deficiency of matter approximately equal in amount to the mass above the sea level: and



Fig. 17.

that below ocean beds there is an excess of matter approximately equal to the deficiency in the ocean when compared with rock; so that the amount of matter in any vertical column drawn from the surface to a level surface below the crust is approximately the same in every part of the earth.

According to this theory, which receives much support from the results of geodetic operations in India, the disturbance of the sea level caused by the apparent masses of continents must be of a very small order. For the disturbance results, as it were, from a mere transference of matter in the earth's crust in a direction to or from the centre. That such a displacement of matter but slightly disturbs the sea level is almost self-evident, but we may get some distinct numerical ideas from the following imaginary case.

### 19.

From a sphere of radius  $c$  and density  $\rho_0$  a sphere of density  $\rho$  is abstracted, its centre being at  $P$  originally is transferred to  $Q$  in the line  $OPSQ$ ,  $O$  being the centre of the first sphere,

and  $S$  a point on its surface. The distance  $SQ$  is to be equal to  $SP = h$ , and the mass of the removed sphere is  $m$ : it is assumed moreover that  $h$  is very small with respect to  $c$ , and that  $m$  is equivalent to a sphere of radius  $h$ . Let  $N$  be a point on an equipotential surface very nearly coinciding with the surface of the original sphere, whose mass is  $M$ ,  $ON = c + y$ , then

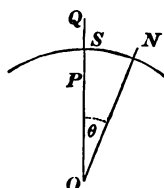

Fig. 18.

$$\frac{M}{c + y} - \frac{m}{NP} + \frac{m}{NQ} = \text{constant};$$

or which is the same

$$y + \frac{\rho}{\rho_0} \beta^3 \left( \frac{c^2}{NP} - \frac{c^2}{NQ} \right) = C,$$

where  $\beta = h : c$ . Now

$$\begin{aligned} NQ &= \{(c+h)^2 + (c+y)^2 - 2(c+h)(c+y)\cos\theta\}^{\frac{1}{2}} \\ &= P \left\{ 1 + \frac{2ch\sin^2\frac{1}{2}\theta}{P^2} + y \frac{2c\sin^2\frac{1}{2}\theta - h\cos\theta}{P^2} \dots \right\}, \end{aligned}$$

where  $P^2 = 4c^2\sin^2\frac{1}{2}\theta + h^2$ ; the square of  $y$  being omitted. If in this expression we change the sign of  $h$ , the value of  $NP$  is obtained: putting also  $2cP_1 = P$ ,

$$\frac{c^2}{NP} - \frac{c^2}{NQ} = \frac{h}{2} \cdot \frac{\sin^2\frac{1}{2}\theta}{P_1^3} - \frac{yh\cos\theta}{4c} \cdot \frac{1}{P_1^3}.$$

Put  $\frac{\rho}{\rho_0} h\beta^3 = \eta$ , then the equation of the surface is

$$y \left\{ 1 - \frac{\eta\cos\theta}{4c} \frac{1}{P_1^3} \right\} + \frac{1}{2}\eta \frac{\sin^2\frac{1}{2}\theta}{P_1^3} = C.$$

But  $\beta$  being very small, we shall omit  $y\beta^3$ , and write the equation thus

$$y + \frac{1}{2}\eta \frac{\sin^2\frac{1}{2}\theta}{(\sin^2\frac{1}{2}\theta + \frac{1}{4}\beta^2)^{\frac{3}{2}}} = C.$$

In order to determine that particular surface, which contains a volume equal to that of the original sphere, we must make the integral of  $y\sin\theta d\theta = 2y d(\sin^2\frac{1}{2}\theta)$  over the



spherical surface equal to zero, or putting  $\sin^2 \frac{1}{2} \theta = x$ ,

$$\int_0^1 C dx - \frac{1}{2} \eta \int_0^1 \frac{x dx}{(x + \frac{1}{4} \beta^2)^{\frac{3}{2}}} = 0;$$

in the last integral we may omit terms of a small order, and thus we get  $C - \eta = 0$ , so that the equation of the surface is

$$y = \eta - \frac{\eta}{2} \frac{\sin^2 \frac{1}{2} \theta}{(\sin^2 \frac{1}{2} \theta + \frac{1}{4} \beta^2)^{\frac{3}{2}}}.$$

Thus the elevation of the sea level at  $S$ , where  $\theta = 0$ , is  $\eta$ , while at the opposite point of the sphere it is half that amount—omitting quantities of a smaller order. The points where  $y$  vanishes are to be found from the cubic equation

$$(z + \beta^2)^3 - z^2 = 0,$$

where  $4 \sin^2 \frac{1}{2} \theta = z$ . The roots of this equation are by approximation

$$z_1 = 1 - 3\beta^2 - 3\beta^4 - \dots, \quad z_2 = \beta^3 + \frac{3}{2}\beta^4 + \dots, \\ z_3 = -\beta^3 + \frac{3}{2}\beta^4,$$

of which the last gives imaginary values of  $\theta$ . The real values are given approximately by

$$\sin \frac{1}{2} \theta = \pm \frac{1}{2}, \quad \sin \frac{1}{2} \theta = \pm \frac{1}{2} \beta^{\frac{3}{2}};$$

the first corresponding to  $\theta = \pm 60^\circ$ , or nearly, while to the second corresponds a very small value of  $\theta$ . Let, in the adjoining figure,  $e f$  be the two points where  $y$  vanishes; then from  $S$  to  $e$ ,  $y$  is positive, from  $e$  to  $f$  it is negative, the greatest negative value being

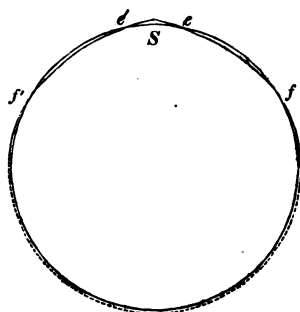

Fig. 19

$$\eta \left( 1 - \frac{2}{3\beta\sqrt{3}} \right),$$

of which the greater part is

$$-\frac{2\eta}{3\beta\sqrt{3}}.$$

From  $f$ ,  $y$  is positive, and increasing up to  $\theta = 180^\circ$ , being represented approximately by

$$\eta \left( 1 - \frac{1}{2 \sin \frac{1}{2} \theta} \right).$$

The greatest alteration of the sea level is the maximum between  $e$  and  $f$ , which occurs at the distance  $h\sqrt{2}$  from  $S$ .

Suppose the small sphere to have a radius of 10 miles, and a density half the density of the large sphere, and that its centre is removed from a depth of 10 miles below the surface to a height of 10 miles above the surface, so that  $h = 10$ , and let  $c = 3960$ . Then the greatest depression between  $e$  and  $f$  will be found to be about 0.8 inch, while the positive elevations become very minute.

### 20.

We shall conclude this chapter by considering the relation of the surface of a lake situated above the sea level to that of sea; and here we leave out of consideration any departures of the sea from the spheroidal form in consequence of attractions of the solid matter in the vicinity of the lake. At the surface of the latter the condition of equilibrium is

$$V + \frac{1}{2} r^2 \omega^2 (1 - \mu^2) = \ominus;$$

also, we have seen that  $g$  being the force of gravity,

$$g = -\frac{d\ominus}{dr}.$$

Hence it follows, that if  $h$  be the height of the lake—being a small quantity— $gh = a$  constant. We may imagine the surface of the lake continued so as to surround the earth, then the distance of this surface from the surface of the sea at any place is inversely proportional to gravity at that place. The surface of a lake then is not exactly parallel to that of the sea, the inclination of these surfaces being measured in the meridian plane. Let  $\phi$  be the latitude,  $I$  the angle between the surface of the lake and that of the (imaginary) sea below it, then

$$I = \frac{dh}{cd\phi},$$

but

$$\frac{dg}{gd\phi} + \frac{dh}{hd\phi} = 0;$$

$$\therefore I = -\frac{h}{c} \frac{dg}{gd\phi},$$

but

$$g = G \{ 1 + (\frac{2}{3}m - e') \sin^2 \phi \};$$

$$\therefore I = -\frac{h}{c} (\frac{2}{3}m - e') \sin 2\phi.$$

It follows from this, that the latitude of a station whose height is  $h$ , as determined by observation, requires the correction  $I$ . But this is practically a very small quantity only amounting to a few tenths of a second for ordinary mountain heights.

To express  $I$  in seconds, the right hand member of the last equation must be divided by  $\sin 1''$ . Then  $c \sin 1''$  being the length of one second on the earth's surface, is approximately 100 feet: also approximately,  $\frac{2}{3}m - e' = 0.0052$ . If then the height expressed in thousands of feet be  $H$ ,

$$I = -0.''052 H \sin 2\phi.$$

## CHAPTER V.

DISTANCES, AZIMUTHS, AND TRIANGLES ON A SPHEROID.

### 1.

ASSUMING that the figure of the earth is an ellipsoid of revolution generated by an ellipse whose semiaxes are  $a$  and  $c$ , so that  $2a$  is the diameter of the equator, and  $2c$  the polar axis, then the equation of the meridian curve is

$$\frac{x^2}{a^2} + \frac{z^2}{c^2} = 1;$$

where  $x$  and  $z$  are the distances of any point in the meridian from the axis of rotation and from the plane of the equator respectively. This equation is satisfied by the values

$$x = a \cos u, \quad z = c \sin u. \quad (1)$$

The latitude of a point on the surface of the earth is the angle made by the normal at that point with the plane of the equator. Let  $\phi$  be the latitude of the point determined as above by  $u$ , and let  $s$  be the length of the elliptic curve of the meridian measured from the equator as far as the point whose latitude is  $\phi$ , then

$$\begin{aligned} -dx &= a \sin u du = \sin \phi ds, \\ dz &= c \cos u du = \cos \phi ds, \end{aligned} \quad (2)$$

whence the relation of  $\phi$  and  $u$ ,

$$a \tan u = c \tan \phi. \quad (3)$$

The angle  $u$  is termed the reduced latitude. Let  $e$  be the eccentricity of the meridian, so that  $a^2 e^2 = a^2 - c^2$ , and put

$$\Delta^2 = 1 - e^2 \sin^2 \phi, \quad \nabla^2 = 1 - e^2 \cos^2 u; \quad (4)$$

then we may readily verify the following relations :

$$\begin{aligned} \Delta \nabla &= \sqrt{1-e^2}, & (5) \\ \nabla \sin \phi &= \sin u, \\ \cos \phi &= \Delta \cos u, \\ \frac{\sin 2\phi}{\Delta} &= \frac{\sin(\phi-u)}{1-\sqrt{1-e^2}} = \frac{\sin 2u}{\nabla}. \end{aligned}$$

Thus the coordinates  $x$  and  $z$  may be written

$$x = \frac{a \cos \phi}{\Delta}, \quad z = \frac{a \sin \phi}{\Delta} (1-e^2). \quad (6)$$

If we differentiate (3), and eliminate  $du$  by (2), we get

$$\frac{ds}{d\phi} = a \frac{1-e^2}{\Delta^3},$$

and this is the radius of curvature of the meridian. Call it  $\epsilon$ , and let  $\rho$  be the radius of curvature of the section of the surface perpendicular to the meridian, this being also the normal terminated by the axis of revolution. Then

$$\epsilon = \frac{a}{\Delta^3} (1-e^2), \quad \rho = \frac{a}{\Delta}. \quad (7)$$

## 2.

In the adjoining figure, let  $O$  be the centre, and  $OP$  the polar semiaxis of the spheroid,  $EQ$  the equator,  $A, B$  points in the meridians  $PAE, PBQ$ :  $a, b$  the projections of  $A, B$  on the axis,  $AN$  the normal at  $A$ ,  $BN$  the intersection of the plane  $ANB$  with the meridian of  $B$ . Let  $K$  be the projection of  $B$  on the plane  $PAEO$ , and draw  $BH, HK$  perpendicular to  $AN$ . Let  $\alpha$  be the azimuth of  $B$  at  $A$ , namely, the inclination of the plane  $NAB$  to the plane  $NAP$ , and if  $90^\circ + \mu$  be the zenith distance of  $B$  at  $A$ , then  $BAN = 90^\circ - \mu$ .

Take  $OE, OP$  as axes of  $x$  and  $z$ , that of  $y$  being at right angles to these, then if  $u, u'$  be the

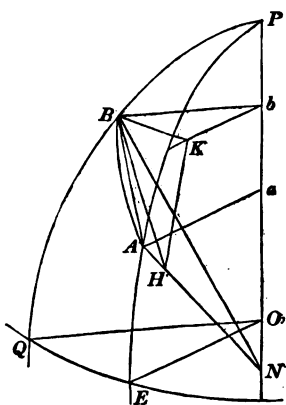

Fig. 20.

reduced latitudes of  $A$  and  $B$ ,  $\omega$  their difference of longitude or the inclination of the planes  $PAE$ ,  $PBQ$ , we have for the coordinates of the two points

$$\begin{aligned} x &= a \cos u, & x' &= a \cos u' \cos \omega, \\ y &= 0, & y' &= a \cos u' \sin \omega, \\ z &= c \sin u, & z' &= c \sin u'. \end{aligned}$$

If  $k$  be the length of the chord or straight line  $AB$ ,

$$k^2 = (x' - x)^2 + (y' - y)^2 + (z' - z)^2$$

and

$$AH = k \sin \mu, \quad HK = k \cos \mu \cos a.$$

If we project the broken line  $AH + HK$  first on  $OE$ , then on  $OP$ , we have

$$\begin{aligned} k(\sin \mu \cos \phi + \cos \mu \cos a \sin \phi) &= a(\cos u - \cos u' \cos \omega), \quad (8) \\ k(-\sin \mu \sin \phi + \cos \mu \cos a \cos \phi) &= c(\sin u' - \sin u), \end{aligned}$$

and  $BK$  is equal to either member of the equation

$$k \cos \mu \sin a = a \cos u' \sin \omega.$$

From (8) eliminate first  $\cos \mu$ , then  $\sin \mu$ , and in the results replace terms in  $\phi$  by their equivalents in  $u$ . Substitute in the expression for  $k$  the values of  $x, x', y, y', z, z'$ , and put, for brevity,  $\Sigma$  for  $\sin u' - \sin u$ , then we get the four following equations:

$$1 - \frac{k^2}{2a^2} = \sin u \sin u' + \cos u \cos u' \cos \omega + \frac{e^2}{2} \Sigma^2, \quad (9)$$

$$\nabla \frac{k}{a} \cos \mu \cos a = \cos u \sin u' - \sin u \cos u' \cos \omega + e^2 \cos u \Sigma,$$

$$\frac{k}{a} \cos \mu \sin a = \cos u' \sin \omega,$$

$$\nabla \frac{k}{c} \sin \mu = 1 - \sin u \sin u' - \cos u \cos u' \cos \omega.$$

The first three of these equations correspond with the fundamental equations, page 40, of Spherical Trigonometry.

Let  $v$  be the third side of the spherical triangle of which two sides are  $90^\circ - u$  and  $90^\circ - u'$ , including an angle  $\omega$ , and let  $\psi$  be a subsidiary angle such that

$$\sin \psi \sin \frac{v}{2} = e \sin \frac{1}{2}(u' - u) \cos \frac{1}{2}(u' + u);$$

further, let  $\alpha', \mu', \Delta'$  represent in relation to the point  $B$  what

$a\mu\Delta$  represent in relation to  $A$ , then we get from the preceding, the following system of equations :

$$\begin{aligned}
 k &= 2a \sin \frac{v}{2} \cos \psi, & (10) \\
 \sin \mu &= \Delta \sin \frac{v}{2} \sec \psi, \\
 \sin \mu' &= \Delta' \sin \frac{v}{2} \sec \psi, \\
 \sin a \cos \mu &= \frac{a}{k} \cos u' \sin \omega, \\
 \sin a' \cos \mu' &= \frac{a}{k} \cos u \sin \omega,
 \end{aligned}$$

which express the distance with the mutual azimuths and zenith distances of two points on a spheroid.

### 3.

If we divide the second of equations (9) by the third, we have

$$\nabla \cot a \cos u' \sin \omega = \cos u \sin u' - \sin u \cos u' \cos \omega + e^2 \cos u \Sigma; \quad (11)$$

substitute here for the terms in  $u, u'$  their equivalents in  $\phi, \phi'$ , then put  $\beta, \beta'$  for what we may term the spherical azimuths, that is the values of  $a, a'$ , when  $e$  is put = 0, then we easily find

$$\begin{aligned}
 \cot a - \cot \beta &= \frac{e^2 \cos \phi}{\Delta \cos \phi'} \left( \frac{\Delta' \sin \phi - \Delta \sin \phi'}{\sin \omega} \right), \\
 -\cot a' + \cot \beta' &= \frac{e^2 \cos \phi'}{\Delta' \cos \phi} \left( \frac{\Delta' \sin \phi - \Delta \sin \phi'}{\sin \omega} \right).
 \end{aligned}$$

By a series of reductions which we shall not here trace out (*Memoirs of the R. A. Soc.*, Vol. xx, page 131), the following result may be obtained from these equations :

$$a + a' = \beta + \beta' + \frac{e^4}{4} \left( \frac{k}{a} \right)^3 \sin a \cos^2 a \sin \phi \cos^3 \phi.$$

Now the maximum value of the small term in  $e^4$  is

$$\frac{1}{8} \cdot \frac{e^4}{4} \left( \frac{k}{a} \right)^3 :$$

if the distance corresponding to  $k$  be  $n$  degrees, this expressed

in seconds is  $0''\cdot0000015 n^3$ , which for a distance of even several hundred miles is practically zero. Hence, the following important theorem: If  $\phi, \phi'$  be the latitudes of two points,  $\omega$  their difference of longitude,  $\alpha, \alpha'$  their mutual azimuths, then

$$\tan \frac{1}{2}(\alpha + \alpha') = \frac{\cos \frac{1}{2}(\phi' - \phi)}{\sin \frac{1}{2}(\phi' + \phi)} \cot \frac{\omega}{2}. \quad (12)$$

Thus it follows that the 'spherical excess' of a spheroidal triangle is equal to that of a spherical triangle whose angular points have the same latitudes and longitudes as the corresponding points of the spheroidal triangle.

#### 4.

Let  $S$  be any point in the curve  $AB$ : from  $S$  draw  $SG$  perpendicular to  $AN$ ; let  $SG = \xi, AG = \zeta$ , so that  $\xi, \zeta$  are the coordinates of  $S$ , then putting

$$f = \frac{e}{\sqrt{1-e^2}} \sin \phi, \quad h = \frac{e}{\sqrt{1-e^2}} \cos \phi \cos \alpha, \quad (13)$$

the equation of the curve  $ASB$  is found to be

$$\xi^2(1+h^2) - 2hf\xi\zeta + \zeta^2(1+f^2) - 2\rho\zeta = 0; \quad (14)$$

this may be obtained in the following manner: if  $J$  be the projection of  $S$  on the meridian plane of  $A$ , the distance of  $J$  from the axis of revolution is

$$x = (\rho - \zeta) \cos \phi - \xi \cos \alpha \sin \phi,$$

while the length of  $SJ$  is

$$y = \xi \sin \alpha,$$

and the distance of  $S$  from the plane of the equator is

$$z = (\rho(1-e^2) - \zeta) \sin \phi + \xi \cos \alpha \cos \phi.$$

These being connected by the relation

$$(1-e^2)(x^2 + y^2) + z^2 = c^2$$

give the equation (14).

From (14) we can deduce the radius of curvature of the vertical section at  $A$ , for it is the limit of the ratio of  $\xi^2 : 2\zeta$



when those quantities vanish. If  $R$  be this radius of curvature

$$\frac{1}{R} = \frac{1}{\rho} \left( 1 + \frac{e^2}{1-e^2} \cos^2 \phi \cos^2 a \right). \quad (15)$$

If we put  $\xi = r \cos \theta$  and  $\zeta = r \sin \theta$ , the equation (14) may be written thus

$$r + r (k \cos \theta - f \sin \theta)^2 - 2R(1+k^2) \sin \theta = 0;$$

from this we may, putting  $\theta = Ar + Br^2 + Cr^3 \dots$ , obtain  $\theta$  in terms of  $r$  by the method of indeterminate coefficients. We shall simply give the result—which is, putting

$$F = \frac{fk}{1+k^2}; \quad H = \frac{f^2-k^2}{1+k^2};$$

$$\theta = \frac{r}{2R} - \frac{1}{2} F \left(\frac{r}{R}\right)^2 + \left(\frac{1}{48} + \frac{1}{8} H + \frac{1}{2} F^2\right) \left(\frac{r}{R}\right)^3$$

$$- \left(\frac{3}{8} FH + \frac{1}{2} F^3\right) \left(\frac{r}{R}\right)^4,$$

which is another form of the polar equation of  $AB$ . If  $s$  be the length of the curve from  $A$  to  $S$

$$s = \int \left( 1 + r^2 \frac{d\theta^2}{dr^2} \right)^{\frac{1}{2}} dr;$$

$$\therefore s = r + \int \left( \frac{1}{2} r^2 \frac{d\theta^2}{dr^2} - \frac{1}{8} r^4 \frac{d\theta^4}{dr^4} \dots \right) dr;$$

and if we substitute in this the values of the differential coefficients derived from the equation of the curve just given, the result after integration is this

$$s = r + \frac{r^3}{24R^2} \left( 1 - 3F \frac{r}{R} \right) + \left( \frac{3}{640} + \frac{3}{80} H + \frac{1}{4} F^2 \right) \frac{r^5}{R^4}$$

$$- \left( \frac{3}{16} FH + \frac{5}{12} F^3 \right) \frac{r^6}{R^5} + \dots$$

If we substitute in the equation just obtained  $k$  for  $r$ , we have the length of the curve joining  $AB$ . Unless, however, in a case in which for some special reason an extreme precision is required, several terms of the series may be rejected. For instance, that involving  $e^2 k^5$  can only amount to a hundredth of a foot in 300 miles, the term in  $e^4 k^4$  is still smaller; so that we may safely put

$$s = k + \frac{k^3}{24R^2} - \frac{e^2 k^4}{16R^3} \cos a \sin 2\phi + \frac{3k^5}{640R^4}.$$

Let  $R'$  be the same function of  $a'\phi'$  that  $R$  is of  $a\phi$ ; then the length of the curve joining  $AB$ , which is formed by the intersection of the surface, and the plane which contains the normal at  $B$  and passes through  $A$  is

$$s' = k + \frac{k^3}{24R'^2} - \frac{e^2 k^4}{16R'^3} \cos a' \sin 2\phi' + \frac{3k^5}{640R'^4}.$$

Now the difference of  $s$  and  $s'$  is of the order  $e^4 k^6$ , and is to be entirely rejected: and if we take for  $s$  the mean of the last two series, it will be seen that in adding them together the terms in  $e^2 k^4$  so far cancel, that their sum becomes a term of a higher order which may be neglected. In fact either series may be represented by

$$s = k + \frac{k^3}{24R_0^2} + \frac{3k^5}{640R_0^4}, \tag{16}$$

where

$$\frac{1}{R_0} = \frac{\sqrt{1-e^2}}{a(\nabla\nabla')^{\frac{1}{2}}} (1 - e^2 \cos^2 u \sin^2 a),$$

$R_0$  being a mean proportional between  $R$  and  $R'$ , or rather very nearly so since  $e^2 \cos^2 u \sin^2 a$  differs inappreciably from  $e^2 \cos^2 u' \sin^2 a'$ .

### 5.

As it may be interesting, as occasion offers, to compare precise results with others obtained by means of approximate formulæ, we here give the results of the calculation by the formulæ just investigated, of the angles and sides of a spheroidal triangle of which are given the latitudes and longitudes of the angular points. Assume for  $A, B, C$  these positions

	Lat.	Long.
$A$ ...	51° 57' N.	... 4° 46' W.,
$B$ ...	53 4 N.	... 4 4 W.,
$C$ ...	50 37 N.	... 1 12 W.;

and take for the elements of the spheroid

$$a = 20926060, \quad c : a = 294 : 295.$$

Also

$$\begin{aligned}\log a &= 7.3206874662, \\ \log e^2 &= 7.8304712628, \\ \log \sqrt{1-e^2} &= 9.9985253144.\end{aligned}$$

The reduced latitudes of  $A$ ,  $B$ ,  $C$ , and the corresponding functions  $\Delta_1$ ,  $\Delta_2$ ,  $\Delta_3$  are first found to be

$$\begin{aligned}A \dots u_1 &= 51^\circ 51' 19''.92163, & \log \Delta_1 &= 9.9990867071, \\ B \dots u_2 &= 52 \ 58 \ 23.43810, & \log \Delta_2 &= 9.9990589251. \\ C \dots u_3 &= 50 \ 31 \ 16.40080; & \log \Delta_3 &= 9.9991202240;\end{aligned}$$

for the subsidiary angles corresponding to the opposite sides

$$\begin{aligned}\log \sin \frac{v_1}{2} &= 8.4217198302, & \log \sin \psi_1 &= 8.6156259752, \\ \log \sin \frac{v_2}{2} &= 8.3562766510, & \log \sin \psi_2 &= 8.4221562901, \\ \log \sin \frac{v_3}{2} &= 8.0187180976; & \log \sin \psi_3 &= 8.6709531435.\end{aligned}$$

Counting azimuths continuously from north round by east and south, the azimuths of the sides are found to be

$$\begin{aligned}AB \dots 20^\circ 39' 17''.2401, & \quad BA \dots 201^\circ 12' 36''.8177, \\ BC \dots 142 \ 55 \ 50.2183, & \quad CB \dots 325 \ 11 \ 7.4013, \\ CA \dots 302 \ 10 \ 54.6710, & \quad AC \dots 119 \ 23 \ 54.3366;\end{aligned}$$

whence the angles

$$\begin{aligned}A &= 98^\circ 44' 37''.0965, \\ B &= 58 \ 16 \ 46.5994, \\ C &= 23 \ 0 \ 12.7303, \\ A+B+C &= 180 \ 1 \ 36.4262.\end{aligned}$$

The distances, chords and curve lines, come out thus,

$$\begin{aligned}k_1 &= 1104249.327, & a &= 1104377.386, \\ k_2 &= 950259.744, & b &= 950341.187, \\ k_3 &= 436473.497, & c &= 436481.410.\end{aligned}$$

Again, take a triangle near the equator, and let the positions of the angular points be as follows:

Lat.	Long.
$A \dots 1^\circ 30' \text{ S.} \dots 0^\circ \ 0' \text{ E.},$	
$B \dots 0 \ 20 \text{ N.} \dots 0 \ 30 \text{ E.},$	
$C \dots 1 \ 30 \text{ N.} \dots 3 \ 0 \text{ E.};$	

then the azimuths, angles, and sides, true to the last place of decimals, are these—

$$\begin{array}{ll}
 AB, & 15^\circ 21' 24''.0371; & BA, & 195^\circ 21' 5''.7090; \\
 BC, & 65 \ 6 \ 46 \ .6939; & CB, & 245 \ 9 \ 10 \ .7078; \\
 CA, & 225 \ 12 \ 16 \ .2131; & AC, & 45 \ 12 \ 16 \ .2131; \\
 \\ 
 A = & 29^\circ 50' 52''.1760; & BC = & 1006266.448 \text{ feet}; \\
 B = & 130 \ 14 \ 19 \ .0151; & CA = & 1544212.630 \text{ feet}; \\
 C = & 19 \ 56 \ 54 \ .4947; & AB = & 689666.750 \text{ feet}.
 \end{array}$$

6.

If the two points whose distance apart is required are on the same meridian, and have latitudes  $\phi, \phi'$ , then

$$s = a \int_{\phi}^{\phi'} \frac{(1-e^2) d\phi}{(1-e^2 \sin^2 \phi)^{\frac{3}{2}}}.$$

It is convenient to replace here  $e^2$  by another symbol  $n$ , such that

$$n = \frac{a-c}{a+c}; \quad \therefore e^2 = \frac{4n}{(1+n)^2},$$

the result is

$$s = c(1+n)(1-n^2) \int_{\phi}^{\phi'} (1+2n \cos 2\phi + n^2)^{-\frac{3}{2}} d\phi.$$

The expansion of  $(1+2n \cos \phi + n^2)^{-\frac{3}{2}}$  will be found at page 51: if we effect the required integration the result is

$$\begin{aligned}
 \frac{s}{c} = & (1+n+\frac{5}{4}n^2+\frac{5}{4}n^3)(\phi'-\phi) \\
 & -(3n+3n^2+\frac{23}{8}n^3) \sin(\phi'-\phi) \cos(\phi'+\phi) \\
 & +(\frac{15}{8}n^2+\frac{15}{8}n^3) \sin 2(\phi'-\phi) \cos 2(\phi'+\phi) \\
 & -\frac{35}{24}n^3 \sin 3(\phi'-\phi) \cos 3(\phi'+\phi).
 \end{aligned}$$

The part of  $s$  which depends on  $n^3$  may always be safely omitted; in fact, for the Russian arc of upwards of  $25^\circ$ , it amounts to only an inch and a half. We may therefore take

$$\begin{aligned}
 \frac{s}{c} = & (1+n+\frac{5}{4}n^2)(\phi'-\phi) - (3n+3n^2) \sin(\phi'-\phi) \cos(\phi'+\phi) \\
 & + \frac{15}{8}n^2 \sin 2(\phi'-\phi) \cos 2(\phi'+\phi). \quad (17)
 \end{aligned}$$

This expresses the length of an arc of the meridian between the latitudes  $\phi$  and  $\phi'$ , the ratio of the semiaxes being

$$1 - n : 1 + n,$$

and the polar semiaxis =  $c$ .

It is customary in geodetical calculations to convert a distance measured along a meridian—when that distance does not exceed a degree or so—into difference of latitude by dividing the length by the radius of curvature corresponding to the middle point, or rather to the mean of the terminal latitudes. And vice versa, small differences of latitude are converted into meridian distance by multiplying the difference of latitude by the radius of curvature at the mean latitude. The amount of error involved in this procedure may be readily expressed by means of the above series; it depends on  $n$ , and the higher powers of  $n$ ; these last we may leave out of consideration, requiring only the principal term of the error. Let  $\phi - \frac{1}{2}a$ ,  $\phi + \frac{1}{2}a$  be the extreme latitudes, then

$$s = c(1+n)a - 3cn \sin a \cos 2\phi,$$

but the radius of curvature is  $c(1+n) - 3nc \cos 2\phi$ , so that

$$s = \rho a + \frac{1}{2} \rho n a^3 \cos 2\phi.$$

The error we are in quest of is therefore  $\frac{1}{2} \rho n a^3 \cos 2\phi$ . This vanishes in the latitude of  $45^\circ$ , and in latitude  $60^\circ$ , it is (since  $n = \frac{1}{800}$  nearly) about  $\frac{1}{2400} \rho a^3$ . For one degree

$$\begin{aligned} \log \rho &\dots 7.320, \\ 2400^{-1} &\dots \bar{4}.620, \\ \sin^3 1^\circ &\dots \bar{6}.726, \\ .046 &\dots \bar{2}.666; \end{aligned}$$

the error is half an inch. For 100 miles it would amount to nearly two inches.

## 7.

We may here notice a source of error that exists in all theodolite observations of horizontal angles. If  $B$  be the projection on the spheroidal surface of a signal  $B'$  at a height  $h$  above  $B$ , then to an observer at  $A$ ,  $B$  and  $B'$  are not in the

same vertical plane, unless  $B$  happens to be in the same latitude as  $A$ . The angle between  $B$  and  $B'$  at  $A$  is in fact, as may be easily verified,

$$\frac{e^2}{2} \frac{h}{a} \sin 2a \cos^2 \phi.$$

This is a very small quantity: in the latitude of Great Britain it can only amount to an eighteenth of a second for every thousand feet of height. If  $h$  be such that, neglecting the consideration of refraction, to the observer at  $A$ ,  $B$  appears at a zenith distance of  $90^\circ$ , then  $h = k^2 : 2a$ , and the error is

$$\frac{e^2}{4} \frac{k^2}{a^2} \sin 2a \cos^2 \phi.$$

### 8.

The plane containing the normal at  $A$  and passing through  $B$ , and that containing the normal at  $B$  and passing through  $A$ , cut the surface in two distinct plane curves. Suppose to fix the ideas that  $A$  and  $B$  are in the northern hemisphere,  $B$  having the greater latitude of the two: then the curve  $APB$  made by the plane containing the normal at  $A$  lies to the south of the curve  $BQA$  corresponding to the plane containing the normal at  $B$ . There is thus a certain ambiguity as to what is to be considered the distance  $AB$ : but this ambiguity is more apparent than real, for the shortest or geodetic distance does not, as we shall see, differ sensibly from the length of either of the plane curves. The direction moreover of  $BQA$  is correct at  $B$ , and that of  $APB$  is right at  $A$ . Among the various curves that may be traced on the surface connecting  $A$  and  $B$ , there are two which have a special claim to attention, viz. one which we shall call the curve of alignment and the other the geodetic line. We shall refer the course of both these to the plane curves, and shall first consider the curve of alignment.

Suppose that an observer between  $A$  and  $B$  provided with a transit theodolite wishes to place himself in line between these points. Shifting his position transversely to the line  $AB$ , he will consider himself in line when he finds that at

the point  $L$  the vertical plane described by his telescope

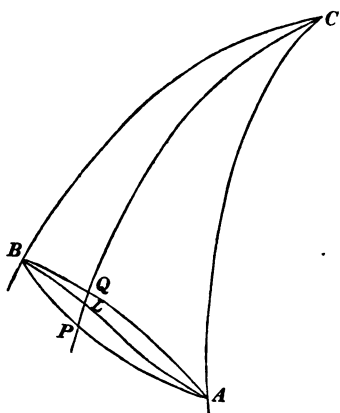

Fig. 21.

passes through both  $A$  and  $B$ . In the adjoining figure let  $CQLP$  be a meridian plane cutting the plane curves in  $Q, P$ , and the curve of alignment in  $L$ . Let  $u, u'$  be the reduced latitudes of  $A$  and  $B$ ; those of  $P, Q, L$  being respectively  $U, U', U$ : also let

$$ACB = \omega, ACQ = \omega,, \\ BCQ = \omega'.$$

Then if  $a$  be the azimuth of  $B$  or  $P$  at  $A$ , (11) gives

$$\nabla \cos u' \sin \omega \cot a = \cos u, \sin u' - \sin u, \cos u' \cos \omega \\ - e^2 \cos u, (\sin u' - \sin u), \\ \nabla \cos U, \sin \omega, \cot a = \cos u, \sin U, - \sin u, \cos U, \cos \omega, \\ - e^2 \cos u, (\sin U, - \sin u),$$

where  $\nabla^2 = 1 - e^2 \cos^2 u,$ . The elimination of  $\cot a$  from these equations, gives equation (18), viz.:

$$\sin U, - N \cos U, = -e^2 \left\{ \sin \omega, \cos U, \frac{\sin u' - \sin u,}{\sin \omega \cos u'} - \sin U, + \sin u, \right\},$$

where

$$N = \frac{\sin u' \cos u, \sin \omega, + \sin u, \cos u' \sin \omega'}{\cos u, \cos u' \sin \omega}$$

Let us here introduce an auxiliary spherical triangle  $ABC$ , in which  $AC = 90^\circ - u,$   $BC = 90^\circ - u',$  and the angle  $ACB = \omega,$  so that  $A$  and  $B$  correspond respectively to  $A$  and  $B$ . In the side  $AB$  take  $D$ , such that  $ACD = \omega,$   $BCD = \omega',$  so that  $D$  corresponds to  $PQ$  or  $L$ . Moreover, let  $CD = 90^\circ - u_0,$   $AD = c,$   $BD = c',$  and  $AB = c,$  then by (8) and (9), pages 41, 42,

$$\sin \omega \tan u_0 = \sin \omega' \tan u, + \sin \omega, \tan u', \\ \sin c \sin u_0 = \sin c' \sin u, + \sin c, \sin u',$$

so that  $\tan u_0 = N$ . It is unnecessary in this investigation to retain terms in  $e^4$  or higher powers, so that in terms multiplied by  $e^2$  we may replace  $U,$  by  $u_0$ . Making this

substitution in (18), and multiplying through by  $\cos u_0$ , we have for  $P$ , on replacing  $\sin(U, -u_0)$  by  $U, -u_0$ ,

$$U, -u_0 = e^2 \cos u_0 \sin u, \frac{2 \sin \frac{c'}{2} \sin \frac{c_1}{2}}{\cos \frac{c}{2}}. \quad (19)$$

Similarly for the point  $Q$ ,

$$U' - u_0 = e^2 \cos u_0 \sin u' \frac{2 \sin \frac{c'}{2} \sin \frac{c_1}{2}}{\cos \frac{c}{2}}.$$

In like manner the condition that the vertical plane at  $L$  passes through both  $A$  and  $B$  gives for  $L$

$$U - u_0 = e^2 \cos u_0 \sin u_0 \frac{2 \sin \frac{c'}{2} \sin \frac{c_1}{2}}{\cos \frac{c}{2}}.$$

Taking the differences of these equations, and multiplying them by  $a$ , we have

$$QP = a e^2 \cos u_0 \frac{2 \sin \frac{c'}{2} \sin \frac{c_1}{2}}{\cos \frac{c}{2}} (\sin u' - \sin u),$$

$$LP = a e^2 \cos u_0 \frac{2 \sin \frac{c'}{2} \sin \frac{c_1}{2}}{\cos \frac{c}{2}} (\sin u_0 - \sin u),$$

$$QL = a e^2 \cos u_0 \frac{2 \sin \frac{c'}{2} \sin \frac{c_1}{2}}{\cos \frac{c}{2}} (\sin u' - \sin u_0).$$

These quantities completely determine the position of  $L$  with respect to the plane curves.

Since the ratio of  $LP : AP$  vanishes when  $AP = c, = 0$ , it is evident that the curve of alignment touches at  $A$  the plane curve  $APB$ , and its azimuth there is consequently the azimuth of  $B$ . So also the curve of alignment has at  $B$  the true azimuth of  $A$ . In tracing this curve two cases arise: first,



$\sin u_0$  may between  $A$  and  $B$  have its values entirely intermediate between  $\sin u$ , and  $\sin u'$ ; in this case the curve lies entirely between  $APB$  and  $BQA$ . But if  $A$  and  $B$ , not supposed to be many degrees apart, are nearly in the same latitude, so that the reciprocal azimuths are both (measured from the north) less than a right angle, then the values of  $\sin u_0$  will not all be between  $\sin u'$  and  $\sin u$ . In such case,  $QL$ , as is easily proved, vanishes when

$$\tan \frac{c}{2} \tan \frac{c}{2} = \frac{\sin u' - \sin u}{\sin u' + \sin u},$$

and this value of  $c$ , determines the point, say  $F$ , when the curve of alignment crosses the plane curve  $BQA$ . Thus, from  $A$  to  $F$ ,  $L$  is between the plane curves, and from  $F$  to  $B$  it lies on the north side of  $FB$ , the actual distance being of the order  $e^2 c^4$ . If  $A$  and  $B$  have the same latitude, the curve of alignment lies wholly to the north of the plane curve between  $A$  and  $B$ .

The angle at which the plane curves intersect, either at  $A$  or  $B$ , is

$$I = e^2 \cos^2 u \sin 2a \sin^2 \frac{c}{2},$$

supposing  $c$  to be small: and if we compare this with the expression, page 130, for the angle which the geodetic curve

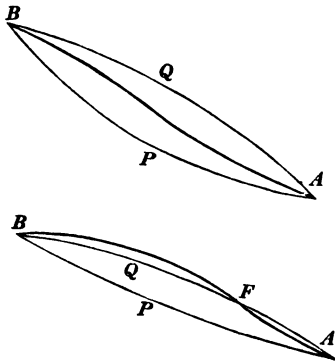

Fig. 22.

starting from  $A$  towards  $B$  makes at  $A$  with the vertical plane there, we see that, neglecting quantities of the order  $e^2 c^3$ , the angle which the geodetic curve makes at  $A$  with the curve  $APB$  is one third of the angle  $I$ , and similarly at  $B$ . But, as we shall see, if we take into account the higher powers of  $c$ , the geodetic crosses  $BQA$  under some circumstances; lying like the curve of alignment

wholly to the north of the plane curves when  $A, B$  having the same latitude, these curves coincide.

9.

In strict analogy with the method followed in plane curves, Gauss defined the curvature of a surface thus: if we have a portion of a surface bounded by any closed curve, and if we draw radii of a unit sphere parallel to the normals at every point of the bounding curve, the area of the corresponding portion of the sphere is the total curvature of the portion of surface under consideration. And if at any point of a surface we divide the total curvature of the element of surface containing the point by the area of that element, the quotient is called the measure of curvature at that point. Let the element of surface be the very small rectangle made by four lines of curvature. Let  $a, \beta$  be the sides of this rectangle,  $\epsilon, \rho$  the corresponding radii of curvature. The normals drawn through the points of the contour lie in four planes cutting each other two and two at right angles. The corresponding radii of the unit sphere form on its surface a rectangle whose sides are  $a : \epsilon$  and  $\beta : \rho$ , and its area  $a\beta : \epsilon\rho$ ; this divided by the area of the rectangle gives  $1 : \epsilon\rho$  as the measure of curvature. Gauss has shown that, if an inextensible but flexible surface be bent or deformed in any way, then the measure of curvature at every point remains the same. Thus, taking a very small portion of a surface at the centre of which the principal radii of

curvature are  $\epsilon, \rho$ , this portion may be fitted to a sphere whose radius is  $(\epsilon\rho)^{\frac{1}{2}}$ . Without attempting a rigid proof, this may be seen as follows:  $FP, PQ$  are the principal sections of a surface through  $P$ —their radii of curvature  $\epsilon, \rho$  respectively.  $P'$  is a point indefinitely near  $P$  in  $FP$ ;  $P'Q'$  a section of the surface by a plane through  $P'$  perpendicular to the plane  $FP$ . Let  $q, q'$  be the projections of  $Q, Q'$  on the plane  $FP$ , so that  $Pq, P'q'$  intersect at the distance  $\epsilon$  from  $P$ .  $PQ = P'Q'$  being a very small quantity ( $=\delta$ ) compared

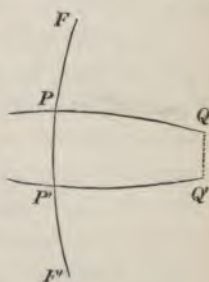

Fig. 23.

the plane  $FP$ . Let  $q, q'$  be the projections of  $Q, Q'$  on the plane  $FP$ , so that  $Pq, P'q'$  intersect at the distance  $\epsilon$  from  $P$ .  $PQ = P'Q'$  being a very small quantity ( $=\delta$ ) compared

with  $\epsilon$  or  $\rho$ ,

$$Pq = P'q' = \frac{s^2}{2\rho},$$

then since  $qq' = QQ'$ ,

$$QQ' : PP' = \epsilon - \frac{s^2}{2\rho} : \epsilon,$$

$$\therefore \frac{PP' - QQ'}{PP'} = \frac{s^2}{2\epsilon\rho}.$$

Hence,  $PP'$  being given, the law of width of the elementary strip of surface  $PQQ'P'$  is the same as if belonging to a sphere of radius  $(\epsilon\rho)^{\frac{1}{2}}$ . Hence, a very small portion of surface round  $P$  may be bent to fit a sphere of that radius. When a surface is so bent, lines drawn on it remain unchanged in length, and angles of intersection remain unchanged. Thus, a small spheroidal triangle whose sides are geodetic lines may be fitted on a spherical surface of radius  $(\epsilon\rho)^{\frac{1}{2}}$ —these quantities corresponding to the centre of the triangle—the geodetic lines retaining their character become arcs of great circles, and the angles of this spherical triangle are the same as those of the spheroidal triangle before deformation.

## 10.

We shall now compare the angles of a spheroidal triangle (viz. the true angles as observed or formed by joining the angular points by curves of alignment) having given sides lying in given azimuths, with a spherical triangle having sides of the same length, and the radius of the sphere being  $(\rho\epsilon)^{\frac{1}{2}}$ , which we shall denote by  $N$ . The higher powers of  $e^2$  are to be neglected, and it is premised that the differences of the angles in question are of the order  $e^2 e^2$ . If  $x, y$  be the coordinates of any point of a curve which passing through the origin touches the axis of  $x$  there, then  $s$  being the length of the curve measured from the origin, we have by Maclaurin's Theorem

$$x = s + \frac{s^2}{1 \cdot 2} \left( \frac{d^2 x}{ds^2} \right) + \frac{s^3}{1 \cdot 2 \cdot 3} \left( \frac{d^3 x}{ds^3} \right) + \dots,$$

$$y = \frac{s^2}{1 \cdot 2} \left( \frac{d^2 y}{ds^2} \right) + \frac{s^3}{1 \cdot 2 \cdot 3} \left( \frac{d^3 y}{ds^3} \right) + \dots;$$

or if  $\rho$  be the radius of curvature at the origin

$$x = s - \frac{s^3}{6\rho^2} + \frac{s^4}{8\rho^3} \left(\frac{d\rho}{ds}\right) + \dots,$$

$$y = \frac{s^2}{2\rho} - \frac{s^3}{6\rho^2} \left(\frac{d\rho}{ds}\right) + \dots,$$

where  $\left(\frac{d\rho}{ds}\right)$  is the value of that differential coefficient at the origin. These may be written

$$x = \rho \sin \frac{s}{\rho} + \frac{s^4}{8\rho^3} \left(\frac{d\rho}{ds}\right) + \dots,$$

$$y = \rho \left(1 - \cos \frac{s}{\rho}\right) - \frac{s^3}{6\rho^2} \left(\frac{d\rho}{ds}\right) + \dots$$

Applying these expressions to the curve of intersection of the spheroidal surface with the plane containing the normal at  $A$  and passing through  $B$ : drop from  $B$  a perpendicular on the normal at  $A$ , and let  $\xi, \eta$  be the coordinates of  $B$ ,  $c$  the length of the curve  $AB$ , and  $R$  the radius of curvature of the section at  $A$ , then

$$\frac{\xi}{R} = \sin \frac{c}{R} + \frac{c^4}{8R^4} \left(\frac{dR}{ds}\right) + \dots,$$

$$\frac{\eta}{R} = 1 - \cos \frac{c}{R} - \frac{c^3}{6R^3} \left(\frac{dR}{ds}\right) + \dots,$$

which may be written thus

$$\frac{\xi}{N} = \sin \frac{c}{N} + \frac{c^3}{3N^2} \left(\frac{1}{N} - \frac{1}{R}\right) + \frac{c^4}{8R^4} \left(\frac{dR}{ds}\right) + \dots,$$

$$\frac{\eta}{N} = 1 - \cos \frac{c}{N} - \frac{c^2}{2N} \left(\frac{1}{N} - \frac{1}{R}\right) - \frac{c^3}{6R^3} \left(\frac{dR}{ds}\right) + \dots$$

Here

$$\frac{1}{R} = \frac{1}{a} \left(1 - \frac{e^2}{2} \sin^2 \phi' + e^2 \cos^2 a \cos^2 \phi'\right),$$

$$\frac{1}{N} = \frac{1}{a} \left(1 + \frac{e^2}{2} - e^2 \sin^2 \phi\right),$$

where  $a$  is the azimuth of  $B$  at  $A$ ,  $\phi'$  the latitude of  $A$ , and  $\phi$  the mean latitude of the triangle. Now it is unnecessary to retain in the expression for  $\xi$  any term of a higher order than  $e^2 c^3$ , or in  $\eta$  any term of a higher order than  $e^2 c^2$ , so

that we may dispense with the term containing  $\left(\frac{d\xi}{ds}\right)$ ; and also in the expression for  $R$  we may substitute for  $\alpha$  the azimuth of  $AB$  at its middle point, call this  $\gamma$ ; and for  $\phi'$  put  $\phi$ . Thus,

$$\frac{1}{N} - \frac{1}{R} = -\frac{e^2 \cos^2 \phi \cos 2\gamma}{2N},$$

and it follows that

$$\xi = N \sin \frac{c}{N} - \frac{e^2 c^3}{6N^2} \cos^2 \phi \cos 2\gamma + \dots, \quad (20)$$

$$\eta = N \left(1 - \cos \frac{c}{N}\right) + \frac{e^2 c^2}{4N} \cos^2 \phi \cos 2\gamma + \dots,$$

$$\xi^2 + \eta^2 = 2N^2 \left(1 - \cos \frac{c}{N}\right) - \frac{e^2 c^4}{12N^2} \cos^2 \phi \cos 2\gamma + \dots$$

We do not require the smaller terms. Thus the position of  $B$  is definitely expressed: and the coordinates  $\xi', \eta'$  of  $C$  are obtained by substituting in the above  $b$  and  $\beta$  for  $c$  and  $\gamma$ .

## 11.

Let  $A, B, C$  be the angles of the spherical triangle whose sides are  $a, b, c$  to the radius  $N$ , and let the angles of the spheroidal triangle be

$$A' = A + dA, \quad B' = B + dB, \quad C' = C + dC,$$

and let the azimuths  $\alpha, \beta, \gamma$  of the sides  $a, b, c$  (at their middle points) be reckoned consecutively from  $0^\circ$  to  $360^\circ$ , and in the same direction as the lettering  $A, B, C$ . Then regarding  $N$  as the unit of length,

$$\xi^2 + \xi'^2 - 2\xi\xi' \cos A' + (\eta' - \eta)^2 = BC^2.$$

But we have also

$$BC^2 = 2(1 - \cos a) - \frac{e^2}{12} a^4 \cos^2 \phi \cos 2\alpha.$$

Substitute for  $\xi\xi'\eta\eta'$ , and put  $\frac{1}{12} e^2 \cos^2 \phi = i$ : then on equating these values of  $BC^2$ , we get after a slight reduction,

$$0 = 2(\cos a - \cos b \cos c - \sin b \sin c \cos A') \\ + ia^4 \cos 2\alpha + ib^2 \cos 2\beta \cdot H + ic^2 \cos 2\gamma \cdot K,$$

where

$$\begin{aligned} H &= 4bc \cos A' - 3c^2 - b^2 = -a^2 - 2ac \cos B, \\ K &= 4bc \cos A' - 3b^2 - c^2 = -a^2 - 2ab \cos C. \end{aligned}$$

Now put for  $\cos A'$  its equivalent  $\cos A - dA \sin A$ , then, if  $\Delta$  be the area of the triangle, the above expression becomes

$$\begin{aligned} \frac{4\Delta}{i} dA &= -a^4 \cos 2\alpha + b^2 \cos 2\beta (a^2 + 2ac \cos B) \\ &\quad + c^2 \cos 2\gamma (a^2 + 2ab \cos C), \end{aligned}$$

which by means of (2), page 38, is reduced to

$$4\Delta dA = 2iabc \sin A \{c \sin(\alpha + \gamma) - b \sin(\alpha + \beta)\}.$$

Thus, we get the first of the following equations; the others follow by symmetry<sup>1</sup>:

$$\begin{aligned} dA &= iabc \left\{ \frac{\sin(\alpha + \gamma)}{b} - \frac{\sin(\beta + \alpha)}{c} \right\}, \\ dB &= iabc \left\{ \frac{\sin(\beta + \alpha)}{c} - \frac{\sin(\gamma + \beta)}{a} \right\}, \\ dC &= iabc \left\{ \frac{\sin(\gamma + \beta)}{a} - \frac{\sin(\alpha + \gamma)}{b} \right\}. \end{aligned} \tag{21}$$

These may also be put in the form

$$\begin{aligned} dA &= ib^2 \sin 2\beta - ic^2 \sin 2\gamma, \\ dB &= ic^2 \sin 2\gamma - ia^2 \sin 2\alpha, \\ dC &= ia^2 \sin 2\alpha - ib^2 \sin 2\beta. \end{aligned} \tag{22}$$

Thus it appears, that to the order of small quantities here retained, the sum of the angles of the spheroidal is equal to the sum of the angles of the spherical triangle. As a numerical example take the large triangle calculated with precision at page 110. The mean of the three values of  $N$  corresponding to the angular points of the triangle is 20942838, and the above formulæ give

$$dA = -0''.093, \quad dB = +0''.132, \quad dC = -0''.039.$$

In fact, if with this value of  $N$ , we convert the sides  $a$ ,  $b$ ,  $c$  of the triangle into arcs, and calculate with precision the angles of the corresponding spherical triangle, we have the following contrast of angles:

<sup>1</sup> *Account of the Principal Triangulation*, page 242.

Spheroidal.	Spherical.
$A' = 98^{\circ} 44' 37.0965''$ ,	$A = 98^{\circ} 44' 37.1899''$ ,
$B' = 58 16 46.5994$ ,	$B = 58 16 46.4737$ ,
$C' = 23 0 12.7303$ ,	$C = 23 0 12.7634$ ,
$\epsilon' = 1 36.4262$ .	$\epsilon = 1 36.4270$ .

Thus the actual difference of the spherical excesses of the two triangles is  $0''.0008$ .

## 12.

Suppose now that using the two sides  $a, b$  of a spheroidal triangle and the included spheroidal angle we calculate by the rules of spherical trigonometry the remaining angles and side, and let it be required to express the errors  $\partial A, \partial B, \partial c$  of the angles and side so obtained. Now in the spherical triangle,  $a, b, C$  give  $A, B, c$ ; and  $a, b, C+dC$  would give

$$A - \frac{a}{c} \cos B dC \text{ instead of } A + dA,$$

$$B - \frac{b}{c} \cos A dC \quad ,, \quad ,, \quad B + dB,$$

$$c + b \sin A dC \quad ,, \quad ,, \quad c.$$

Therefore, since  $dA + dB + dC = 0$ ,

$$\partial A = \frac{ab}{c} \left\{ -\frac{dA}{a} \cos A + \frac{dB}{b} \cos B \right\},$$

$$\partial B = \frac{ab}{c} \left\{ \frac{dA}{a} \cos A - \frac{dB}{b} \cos B \right\},$$

$$\partial c = \frac{ab}{c} \sin C dC.$$

Substituting the values we have obtained for  $dA, dB$ ,

$$\partial A = iab \{ 2 \sin(a+\beta) + \sin 2\gamma \cos(a-\beta) \}, \quad (23)$$

$$\partial B = -iab \{ 2 \sin(a+\beta) + \sin 2\gamma \cos(a-\beta) \}.$$

Again, if with the side  $c$  of a spheroidal triangle, and the adjacent spheroidal angles, we calculate the other two sides by the rules of spherical trigonometry, their errors will be, as we may easily verify,

$$\partial a = i \frac{abc}{\sin C} \{2 \sin(a + \gamma) + \sin 2\beta \cos(a - \gamma)\}, \quad (24)$$

$$\partial b = -i \frac{abc}{\sin C} \{2 \sin(\beta + \gamma) + \sin 2\alpha \cos(\beta - \gamma)\}.$$

Thus the greatest error that can arise in the calculated side of a triangle on account of the spheroidal form of the surface, is less than

$$\frac{e^2}{4} \cos^2 \phi \frac{abc}{\sin C},$$

where  $C$  is the angle opposite the base or given side.

If in the case of our spheroidal triangle of reference we calculate from the given side  $c$  the sides  $a$ ,  $b$ , their errors are +0.5 ft. and +0.7 ft., which are very small in respect to those large distances, viz.  $a = 209$  miles,  $b = 180$  miles.

It follows therefore that spheroidal triangles may be calculated as spherical triangles, that is to say, they may be calculated by using Legendre's Theorem, and obtaining the spherical excess from the formula

$$\epsilon = \frac{ab \sin C'}{2 \rho \sin 1''}. \quad (25)$$



## CHAPTER VI.

### GEODETIC LINES.

THE geodetic line has always held a more important place in the science of geodesy amongst the mathematicians of the continent, than has been assigned to it in the operations of the English and Indian Triangulations. Here, indeed, it has been completely set aside, partly because the long arcs measured are in the direction of the meridian—itsself a geodetic line—and partly because the actual angles of a geodetic triangle cannot be observed, since, as we shall see, the azimuth of a geodetic, as it starts from a point *A* to a point *B*, is different from the astronomical azimuth of *B* at *A*. But the difference of length between the plane curve distance *AB* and the geodetic distance is all but immeasurably small for any such distance as three or four degrees. It may also be proved that the calculation of spheroidal triangles as spherical is correct only when the observed angles have been reduced to the geodetic angles, that is, the angles in which the geodetic lines joining the three vertices intersect. Still the difference is so very small that for such triangles as are formed by mutually visible points on the earth's surface it has been generally disregarded. We do not however conclude that geodetic lines have no necessary place in geodesy. Both the extreme precision now attained in the measures of base lines and angles, and the vast extents of country over which triangulations are being carried, make the consideration of even the smallest refinements not superfluous.

1.

We shall now investigate briefly the nature of the geodetic line—as the shortest line—on the surface of an ellipsoid of revolution. Suppose the position of a point on the surface to be defined by its distance  $\zeta$  measured from one of the poles along a meridian, and by its longitude  $\omega$  measured from a fixed meridian, then,  $r$  being the distance of the point from the axis of revolution, the length of a curve traced on the surface is

$$s = \int (r^2 d\omega^2 + d\zeta^2)^{\frac{1}{2}}.$$

This length is to be a minimum between the given extremities. We shall most readily arrive at the characteristic of the curve by giving a variation  $\delta\omega$ , a function of  $\zeta$ , to  $\omega$ . Thus,

$$\begin{aligned} \delta s &= \int \frac{r^2 d\omega}{ds} d. \delta\omega \\ &= \delta\omega \frac{r^2 d\omega}{ds} - \int \delta\omega d \left( \frac{r^2 d\omega}{ds} \right); \end{aligned}$$

consequently, for the minimum,

$$r^2 d\omega = C ds. \tag{1}$$

To fix our ideas, let longitude be measured positively from west to east, and azimuths from north through east round to north. Let  $a$  be the azimuth of the element  $ds$  of the curve, then

$$\begin{aligned} ds \cos a &= -d\zeta, \\ ds \sin a &= r d\omega, \end{aligned}$$

and the second of these substituted in the characteristic of minimum gives

$$r \sin a = C.$$

If  $u$  be the reduced latitude,  $r = a \cos u$ , where  $a$  is the semiaxis major of the spheroid; and if  $u, a$ , be the initial values of  $u, a$  at the point  $A$ , say, then

$$\cos u \sin a = \cos u, \sin a. \tag{2}$$

The relation here expressed is that which exists in a spherical triangle  $\mathbb{A}\mathbb{B}\mathbb{C}$ , whose sides are  $\mathbb{A}\mathbb{C} = 90^\circ - u$ ; and  $\mathbb{B}\mathbb{C} = 90^\circ - u$ , and the angles opposite to them  $\mathbb{C}\mathbb{A}\mathbb{B} = a$ , and

$\mathcal{C}\mathcal{B}\mathcal{A} = 180^\circ - \alpha$ . Let the third side of this triangle be  $\sigma$ , and the third angle  $\mathcal{C} = \varpi$ , then

$$\begin{aligned} d\sigma \cos \alpha &= du, \\ d\sigma \sin \alpha &= \cos u d\varpi. \end{aligned}$$

If  $\phi$  be the latitude of a point on the geodetic

$$\begin{aligned} \sin \phi &= \frac{\sin u}{(1 - e^2 \cos^2 u)^{\frac{1}{2}}}, \\ dr &= d\zeta \sin \phi = -a \sin u du, \end{aligned}$$

whence we obtain

$$\begin{aligned} ds &= a(1 - e^2 \cos^2 u)^{\frac{1}{2}} d\sigma, \\ d\omega &= (1 - e^2 \cos^2 u)^{\frac{1}{2}} d\varpi. \end{aligned} \quad (3)$$

This completely determines the auxiliary spherical triangle, and through it the latitude and longitude of any point at a distance  $s$  from  $A$  measured along a geodetic which has a given initial azimuth. The spherical triangle gives

$$d\varpi = d\sigma \frac{\sin \alpha}{\cos u} = \frac{\sin \alpha, \cos u}{\cos^2 u} d\sigma,$$

by which we may eliminate  $d\varpi$  from the second of (3). If we omit the higher powers of  $e^2$ , we have, on integrating this last-mentioned equation,

$$\omega = \varpi - \frac{e^2}{2} \int \cos^2 u d\varpi = \varpi - \frac{e^2}{2} \sigma \sin \alpha, \cos u, \quad (4)$$

## 2.

Before applying these results to the calculation of distances we shall first trace the course of a geodetic line, joining two given points  $AB$  on a spheroid, and in this process we shall omit the higher powers of  $e^2$ . Let  $G$  be a point on the geodetic joining two points  $A$  and  $B$ . Let  $ss'$  be the distances of  $G$  and  $B$  from  $A$ , measured along the geodetic,  $\sigma \sigma'$  the corresponding values of  $\sigma$ ,  $\omega \omega'$  the longitudes of  $G$  and  $B$ ,  $u u'$  their reduced latitudes. Let  $\mathcal{C}$  be a point on the side  $\mathcal{A}\mathcal{B}$  of the auxiliary spherical triangle  $\mathcal{A}\mathcal{B}\mathcal{C}$  corresponding to  $G$ , so that  $\mathcal{A}\mathcal{C} = \sigma$ ,  $\mathcal{A}\mathcal{B} = \sigma'$ ,  $\mathcal{A}\mathcal{C}\mathcal{C} = \varpi$ ,  $\mathcal{A}\mathcal{C}\mathcal{B} = \varpi'$ ,

$\mathfrak{C}\mathfrak{C} = 90^\circ - u$ ,  $\mathfrak{B}\mathfrak{C} = 90^\circ - u'$ ; then we have the three following equations:

$$\begin{aligned} \sin u &= \sin u_1 \cos \sigma + \cos u_1 \sin \sigma \cos a_1, \\ \sin u_1 &= \sin u_1 \cos \sigma' + \cos u_1 \sin \sigma' \cos a_1, \\ \sin \varpi' \tan u &= \sin \varpi \tan u' + \sin (\varpi' - \varpi) \tan u_1; \end{aligned}$$

the last, by equation (9) page 42. Now from (4)

$$\begin{aligned} \varpi &= \omega + \frac{e^2}{2} \sigma \sin a_1 \cos u_1, \\ \varpi' &= \omega' + \frac{e^2}{2} \sigma' \sin a_1 \cos u_1; \end{aligned}$$

and if for convenience we write  $\omega_1, \varpi_1, \sigma_1$  for  $\omega' - \omega, \varpi' - \varpi, \sigma' - \sigma$ , then

$$\begin{aligned} \sin \varpi &= \sin \omega + \frac{e^2}{2} \sigma \sin a_1 \cos u_1 \cos \omega, \\ \sin \varpi' &= \sin \omega' + \frac{e^2}{2} \sigma' \sin a_1 \cos u_1 \cos \omega', \\ \sin \varpi_1 &= \sin \omega_1 + \frac{e^2}{2} \sigma_1 \sin a_1 \cos u_1 \cos \omega_1. \end{aligned}$$

We have now to substitute these in the equation above which contains  $\tan u$ . If  $a'$  be the azimuth of the geodesic at  $B$ , we have

$$\begin{aligned} \sin \sigma' \cos a_1 &= \cos u_1 \sin u' - \sin u_1 \cos u' \cos \varpi', \\ -\sin \sigma' \cos a' &= \cos u' \sin u_1 - \sin u' \cos u_1 \cos \varpi', \end{aligned}$$

by means of which, and some obvious simplifications, we get

$$\begin{aligned} \sin \omega' \tan u &= \sin \omega \tan u' + \sin \omega_1 \tan u_1, \\ &+ \frac{e^2}{2} (\sigma \cos a_1 \sin \omega_1 - \sigma_1 \cos a' \sin \omega). \end{aligned} \tag{5}$$

Take now, as at page 114, an auxiliary spherical triangle  $ABC$  corresponding point for point with  $ABC$  and  $\mathfrak{A}\mathfrak{B}\mathfrak{C}$ , so that  $BC = 90^\circ - u'$ ,  $AC = 90^\circ - u_1$ ,  $ACB = \omega'$ ; on  $AB$  take  $G$ , such that  $ACG = \omega$ ,  $GCB = \omega_1$ , then if  $CG = 90^\circ - u_0$ ,

$$\sin \omega' \tan u_0 = \tan u' \sin \omega + \tan u_1 \sin \omega_1, \tag{6}$$

as at the page above referred to;  $u_0$  is the same in both cases on the supposition of  $AB$  being the same points in the one case as in the other, the intermediate point being also the same.

Now since  $e^4$  is to be neglected, we may put within the parenthesis in (5)

$$\sin \omega, = \sin \omega' \frac{\cos u, \sin \sigma,}{\cos u \sin \sigma'},$$

$$\sin \omega = \sin \omega' \frac{\cos u' \sin \sigma}{\cos u \sin \sigma'}.$$

After making this substitution, taking the difference of (5) and (6), and putting  $\tan u - \tan u_0 = (u - u_0) \sec^2 u$ , we get finally

$$u - u_0 = \frac{e^2}{2} \cos u \left( \frac{\sigma \sin \sigma,}{\sin \sigma'} \cos u, \cos a, \right. \\ \left. - \frac{\sigma, \sin \sigma}{\sin \sigma'} \cos u' \cos a' \right). \quad (7)$$

To compare this with the equations at page 115; the points  $AB$  we are now dealing with are to be considered the same as the points  $AB$  of that investigation, and our present point  $G$  is on the same meridian with  $P, L$  and  $Q$ , thus the  $c'c'$ , of those formulæ correspond respectively with  $\sigma, \sigma, \sigma$  of (7), and we know fully the course of the geodetic compared with either the plane curves or the curve of alignment. From the last equation written down and (19) we get for the distance of  $G$  north of  $P$ ,<sup>1</sup>

$$PG = a \frac{e^2}{2} \cos u \left\{ \frac{\sigma \sin \sigma,}{\sin \sigma'} \cos u, \cos a, - \frac{\sigma, \sin \sigma}{\sin \sigma'} \cos u' \cos a' \right. \\ \left. - \frac{4 \sin \frac{\sigma}{2} \sin \frac{\sigma,}{2}}{\cos \frac{\sigma'}{2}} \sin u, \right\}.$$

We may alter the form of this by eliminating  $a'$  through the equation

$$-\cos u' \cos a' = \sin u, \sin \sigma' - \cos u, \cos \sigma' \cos a,$$

thus getting

$$PG = a \frac{e^2}{2} \cos u (H \cos u, \cos a, + K \sin u,), \quad (8)$$

<sup>1</sup> See *Philosophical Magazine*, May, 1870. 'On the course of geodetic lines on the earth's surface,' by Captain Clarke, R.E., from which much of this chapter is taken.

where

$$H = \frac{\sigma \sin \sigma_1}{\sin \sigma'} - \frac{\sigma_1 \sin \sigma}{\tan \sigma'},$$

$$K = \sigma_1 \sin \sigma - 4 \frac{\sin \frac{\sigma}{2} \sin \frac{\sigma_1}{2}}{\cos \frac{\sigma'}{2}}.$$

If we desire to trace the course of a geodetic line, not as passing through two given points, but as starting from a point  $A$  in a given azimuth, we may refer its different points to the corresponding points of the curve of intersection of the vertical plane at  $A$  which touches the geodetic at that point. In order to do this we must put in (8)  $\sigma' - \sigma = \sigma_1$ , and in the result put  $\sigma' = 0$ , making the point  $B$  move up to  $A$  along the geodetic. The result of this operation is

$$PG = \frac{ae^2}{2} \cos u \sin \sigma \left\{ \left( \frac{\sigma}{\tan \sigma} - 1 \right) \cos u, \cos a, \right. \\ \left. - \left( \sigma - 2 \tan \frac{\sigma}{2} \right) \sin u, \right\}, \quad (9)$$

where, with respect to the sign of  $PG$ , it is to be remembered that  $PG = a(u - U)$ . From this we can readily infer the following: if  $A$  be the true azimuth at  $A$  of  $B$ ,  $a$ , the azimuth of the geodetic to  $B$  at  $A$ ,  $\alpha$  the azimuth at  $B$ ,

$$A - \alpha, = - \frac{PG \sin \alpha}{a \sin \sigma} \\ = \frac{e^2}{2} \cos u, \sin \alpha, \left\{ \left( 1 - \frac{\sigma}{\tan \sigma} \right) \cos u, \cos a, \right. \\ \left. + 2 \left( \frac{\sigma}{2} - \tan \frac{\sigma}{2} \right) \sin u, \right\}, \quad (10)$$

a formula which is given by Bessel in the *Astronomische Nachrichten*, Nos. 3 and 330.

We infer from this formula, that the azimuth of the geodetic is equal to the true azimuth when the following condition exists:

$$\cot u, \cos a, = 2 \frac{\tan \frac{\sigma}{2} - \frac{\sigma}{2}}{1 - \frac{\sigma}{\tan \sigma}}. \quad (11)$$

When  $\sigma$  is small, then approximately

$$A - \alpha, = \frac{e^2}{6} \cos u, \sin \alpha, \left\{ \sigma^2 \cos u, \cos \alpha, - \frac{\sigma^3}{4} \sin u, \right\}. \quad (12)$$

### 3.

Let us now consider the case of geodetic lines starting from a point on a spheroid of small excentricity and diverging in all directions. First to confine our attention to a single line, it is well known, and may be inferred from the auxiliary spherical triangle, that a geodetic touches alternately two parallels equidistant from the poles—the difference of longitude between the successive points of contact being constant, and something less, than  $180^\circ$  depending on the angle at which it cuts the equator. Now suppose a line starting from a point on the equator with azimuth  $\alpha$ , the osculating plane at that point cuts the equator again at the opposite point  $N$ . As a point  $P$  moves along the geodetic towards  $N$ , the angle  $\sigma$  of the auxiliary spherical triangle increases from 0, and when it becomes  $\pi$  then  $\sigma$  also becomes  $= \pi$ , and  $P$  has reached the equator, its longitude being  $\pi - \frac{1}{2} e^2 \pi \sin \alpha$ . Since, in (9),  $\sigma \cot \sigma - 1$  is negative for all values of  $\sigma$  from 0 to  $\pi$ , the geodetic lies wholly on the south side of the osculating plane at the initial point, if we suppose  $\alpha < 90^\circ$ , and its distance south when  $\sigma = \pi$  and  $P$  is on the equator is  $\frac{1}{2} \pi e^2 \cos \alpha$ . We infer from this that all geodetics proceeding from the same point on the equator have an approximately equal length  $\frac{1}{2} \pi e^2$ —about 36' in the case of the earth—intercepted between the meridian through  $N$  and the equator. Consequently, the ultimate intersections of the geodetics will form an envelope like the evolute of an ellipse or the hypocycloid

$$x^{\frac{2}{3}} + y^{\frac{2}{3}} = k^{\frac{2}{3}},$$

$N$  being the centre of the curve. If geodetic lines starting from a given point intersect so as to form an envelope, then each line is a shortest one only up to its point of contact with the envelopé and no further (Jacobi: *Vorlesungen über Dynamik*, Berlin, 1866). If the lines diverge from a point

not on the equator, but in latitude  $u$ , the diameter of the envelope will vary as  $\cos^2 u$ .

4.

In the case of a geodetic joining two points which are a short distance apart, the line will generally lie between the plane curves, and neglecting quantities of the order  $e^2 \sigma^4$  it is easy to see from what precedes that

$$\frac{PG}{PQ} = \frac{\sigma + \sigma'}{3\sigma'} = \frac{1}{3} + \frac{\sigma - \sigma'}{6\sigma'}$$

so that the geodetic divides the angle at  $P$  into parts in the proportion of 1 : 2, and the angle at  $Q$  into parts in the ratio of 2 : 1. If, however, we take in quantities of a higher order we find that the curve under some circumstances, namely, when the terminal stations are nearly in the same latitude, crosses one of the plane curves. To determine the condition of crossing we must make the expression for  $PG$  in (8) vanish,

thus,  $\frac{H}{\sigma\sigma'} \cot u, \cos a, + \frac{K}{\sigma\sigma'} = 0$  gives the condition of the geodetic crossing the plane curve which contains the normal at  $A$ . In the expressions for  $\frac{H}{\sigma\sigma'}$  and  $\frac{K}{\sigma\sigma'}$ , substitute for the sines and cosines their expansions in series, and the condition of crossing becomes

$$(\sigma + \sigma') \cot u, \cos a, = \frac{1}{4} (\sigma^2 + \sigma\sigma' + \sigma'^2) + \frac{1}{120} (\sigma^4 + \sigma^3\sigma' - \sigma^2\sigma'^2 + \sigma\sigma'^3 + \sigma'^4). \quad (13)$$

If the crossing be indefinitely near  $A$  we must here put  $\sigma = 0$ , which gives

$$\cot u, \cos a, = \frac{\sigma'}{4} \left(1 + \frac{\sigma'^2}{30}\right).$$

If the crossing be very near  $B$  we must put  $\sigma = \sigma'$ ,

$$\cot u, \cos a, = \frac{3\sigma'}{8} \left(1 + \frac{\sigma'^2}{30}\right).$$

Now laying aside for a moment the consideration of the earth being non-spherical, that is, supposing  $e=0$  drop a perpendicular from the pole  $C$  on the arc  $AB$ , and let it meet  $AB$  in  $S$  between  $A$  and  $B$ , and let  $AS=iAB$ , then, by spherical



trigonometry,  $\cot u, \cos a, = \tan i \sigma' = i \sigma' + \frac{1}{3} i^3 \sigma'^3$ . Supposing then  $\sigma$  to be very small, in order that the geodetic may cross the northern curve,  $AS$  must be between  $\frac{1}{4} AB$  and  $\frac{3}{8} AB$ ,  $A$  being under these circumstances the northernmost of the two terminal stations. The limits of azimuth under which crossing takes place are therefore very small.

Supposing the case in which the points  $A, B$  are on the same parallel of latitude, let  $L$  be the point on the curve of alignment, which is on the same meridian as  $G$  on the geodetic, then when  $\sigma'$  is small

$$PL = \frac{ae^2}{4} \sigma^2 \sigma'^2 \cos u \sin u,$$

$$PG = \frac{ae^2}{24} \sigma \sigma' (\sigma^2 + 3\sigma\sigma' + \sigma'^2) \cos u \sin u,$$

and in the middle part of the arc, the geodetic lies between the coincident plane curves and the curve of alignment.

## 5.

Let us now determine the difference in length between the geodetic and the other curves in the case of a short line: and first between the geodetic and the curve  $P$ . Let  $\delta u$  be the difference of latitude of the corresponding points  $G$  and  $P$  of these curves,  $G$  being north of  $P$  by the distance  $a\delta u$ . Draw an arc of parallel through  $G$ , meeting the plane curve in the point  $R$  east of  $G$ , then the difference of longitude of  $R$  and  $G$  is  $\delta\omega = \delta u \tan a \sec u$ , and we may suppose all the points of the plane curve to be referred in this manner to the geodetic. Now when  $\omega$  is increased by  $\delta\omega$

$$\frac{ds}{d\zeta} = \left( r^2 \frac{d\omega^2}{d\zeta^2} + 1 \right)^{\frac{1}{2}}$$

is increased by

$$r^2 \frac{d\omega}{ds} \left( \frac{d\delta\omega}{d\zeta} \right) + \frac{1}{2} \left( \frac{d\delta\omega}{d\zeta} \right)^2 \frac{r^2 d\zeta^3}{ds^3},$$

the first term of which when integrated is, by reason of the character of the geodetic, zero. Hence the increment of

length in passing from the geodetic to the plane curve is, since  $ds \cos a = -d\zeta$

$$\delta s = -\frac{1}{2} a^2 \int \cos^2 u \cos^3 a \left( \frac{d\delta\omega}{d\zeta} \right)^2 d\zeta,$$

and as we require merely the first or principal term in the value of  $\delta s$ , we may put  $d\zeta = -adu$ , and so

$$\delta s = \frac{1}{2} a \cos^2 u \cos^3 a \int \left( \frac{d\delta\omega}{du} \right)^2 du.$$

Let the whole length of the line be  $c$ , the distance of  $G$  from the initial point  $A$  being as before  $=\sigma$ . Now, omitting small quantities of the fourth order, the equation (8) gives

$$PG = a \frac{e^2}{6} \sigma (c-\sigma) (c+\sigma) \cos^2 u \cos a,$$

whence we have

$$\delta\omega = \frac{1}{8} e^2 \sigma (c^2 - \sigma^2) \sin a \cos u,$$

and 
$$\left( \frac{d\delta\omega}{du} \right)^2 du = \left( \frac{d\delta\omega}{d\sigma} \right)^2 \frac{d\sigma}{du} d\sigma;$$

$$\begin{aligned} \therefore \delta s &= \frac{ae^4}{288} \cos^4 u \sin^2 2a \int_0^c (c^2 - 3\sigma^2)^2 d\sigma \\ &= \frac{ae^4}{360} c^5 \cos^4 u \sin^2 2a. \end{aligned} \tag{14}$$

This gives an approximation to the truth, only when the distance  $c$  is not very large. The coefficient  $\frac{1}{8} \frac{1}{6} a e^4$  is only 2.66 feet: and if  $c$  were for instance  $10^\circ$ , the maximum value of  $\delta s$  would be less than a hundredth of an inch. For the curve of alignment, the difference of length between it and the geodetic is obtained by putting

$$\delta\omega = \frac{1}{8} e^2 \sigma (c-\sigma) (2\sigma-c) \sin a \cos u,$$

and by the same process as before, we get

$$\delta s = \frac{ae^4 c^5}{1440} \sin^2 2a \cos^4 u,$$

which is one-fourth part of the difference in the case of the plane curve.

The difference of length of the two plane curves is of a higher order.

<sup>1</sup> Bessel, *Astron. Nachr.*, No. 330, p. 285. The demonstration is not given.

## 6.

From the expression (12) we can compare the angles of a geodetic triangle on a spheroid with the true spheroidal angles. Let  $ABC$  be the triangle, its sides being  $a, b, c$ : measuring the azimuths consecutively from  $0^\circ$  to  $360^\circ$ , let the true and geodetic azimuths of  $C$  at  $B, A$  at  $C, B$  at  $A$  be  $(\alpha), (\beta), (\gamma)$  and  $\alpha, \beta, \gamma$  respectively: and denote the reverse azimuths of  $B$  at  $C, C$  at  $A, A$  at  $B$  by  $(\alpha'), (\beta'), (\gamma')$  for the true,  $\alpha, \beta, \gamma$ , for the geodetic azimuths. We propose to retain only the part of (12) depending on  $\sigma^2$ , omitting the smaller term. In doing this we become at the same time at liberty to put for  $\cos^2 u$ , (which varies from point to point of the triangle),  $\cos^2 u$  where  $u$  refers to the centre say of the triangle; and in the factor  $\sin 2\alpha$ , we need not distinguish between the direct and reverse azimuth of the sides of the triangle. Thus, we get, putting  $i = \frac{1}{2} c^2 \cos^2 u$ ,

$$(\alpha) = \alpha + i a^2 \sin 2\alpha,$$

$$(\alpha') = \alpha' + i a^2 \sin 2\alpha,$$

$$(\beta) = \beta + i b^2 \sin 2\beta,$$

$$(\beta') = \beta' + i b^2 \sin 2\beta,$$

$$(\gamma) = \gamma + i c^2 \sin 2\gamma,$$

$$(\gamma') = \gamma' + i c^2 \sin 2\gamma.$$

Thus the true angles of the triangle are

$$A = (\beta') - (\gamma) = \beta' - \gamma + i (b^2 \sin 2\beta - c^2 \sin 2\gamma),$$

$$B = (\gamma') - (\alpha) = \gamma' - \alpha + i (c^2 \sin 2\gamma - a^2 \sin 2\alpha),$$

$$C = (\alpha') - (\beta) = \alpha' - \beta + i (a^2 \sin 2\alpha - b^2 \sin 2\beta).$$

Now, at page 121, we have brought out the differences between the true angles of a spheroidal triangle and the angles of a spherical triangle with the same sides—the radius of the sphere corresponding to the mean measure of curvature of the triangle; and it appears on a comparison of these results that the angles of the geodetic triangle are equal respectively to those of the spherical triangle, to quantities of the order  $i a^2$ .

7.

It will be interesting here to compute some actual numerical examples of the course of geodetic lines. Take for the elements of the spheroid  $a=20926060$ ,  $a:b=295:294$ , which give  $\log \frac{1}{2}ae^2=4.85013$ . We shall first take the geodetic line joining the Kurrachee base line in the West of India with the Calcutta base line. The approximate latitudes are Kurrachee  $25^\circ 0'$ , Calcutta  $22^\circ 30'$ , and the difference of longitude  $21^\circ 10'$ . From these we obtain,  $\sigma$  being the entire distance and  $u$  the latitude of the middle point,

$$\begin{aligned} a, &= 92^\circ 58', & a' &= 101^\circ 34', \\ \sigma &= 19^\circ 40', & u &= 24^\circ 7'. \end{aligned}$$

Now, at the middle point of the arc, the value of  $PG$ —which is the distance of the geodetic north of the plane which is vertical at Calcutta and passes through Kurrachee—is

$$PG = a \frac{e^2}{2} \cos u \frac{\sin^2 \frac{\sigma}{4}}{\cos \frac{\sigma}{2}} \left( \frac{\frac{\sigma}{4}}{\tan \frac{\sigma}{4}} \sin u - \sin u \right),$$

which gives 46.6 feet as the distance of the geodetic north of the plane curve. The differences of the azimuths of the geodetic from those of the vertical planes are, at Calcutta  $3''.76$ , and at Kurrachee  $2''.04$ .

As a second example, take the line joining the Cathedral of Bordeaux in latitude  $44^\circ 50' 20''$  with the observatory at Nicolaëff in latitude  $46^\circ 58' 20''$ ; the spherical distance of these points being  $22^\circ 35' 30''$ . By spherical trigonometry we get at Bordeaux the azimuth of Nicolaëff  $= 72^\circ 55' 7''$ , and at Nicolaëff the azimuth of (i.e. the angle between the north meridian and) Bordeaux  $= 83^\circ 23' 14''$ . Take Bordeaux as the initial point, and let the whole distance be divided into ten equal parts, and through each point of division let a portion of a meridian line be drawn intersecting the plane curves  $P$ ,  $Q$ , and the geodetic. The former plane curve is that which is formed by the plane containing the vertical at Bordeaux,

and it lies entirely to the south of  $Q$ , that is, between the terminal points. We have also included in the calculation the curve of alignment, intersecting each meridian  $PQ$  in the point  $L$  as the geodetic intersects it in  $G$ : thus the relative course of these two lines will be seen. The first column of the following table contains the successive distances of the intermediate points from Bordeaux:—

$c$ ,	LATITUDE OF $P$	$Q$ NORTH OF $P$	$L$ NORTH OF $P$	$G$ NORTH OF $P$	$L$ NORTH OF $G$	$G$ NORTH OF $Q$
° ' "	° ' "	ft.	ft.	ft.	ft.	ft.
0 0 0	44 50 20	0.0	0.0	0.0	0.0	0.0
2 15 33	45 27 41	18.26	5.40	14.00	- 8.60	- 4.26
4 31 6	45 59 58	32.19	17.66	26.53	- 8.87	- 5.66
6 46 39	46 26 58	41.93	31.80	36.70	- 4.90	- 5.23
9 2 12	46 48 33	47.62	44.04	43.77	+ 0.27	- 3.85
11 17 45	47 4 32	49.36	51.71	47.20	+ 4.51	- 2.16
13 33 18	47 14 51	47.23	53.19	46.54	+ 6.65	- 0.69
15 48 51	47 19 23	41.25	47.88	41.57	+ 6.31	+ 0.32
18 4 24	47 18 8	31.42	36.17	32.13	+ 4.04	+ 0.71
20 19 57	47 11 6	17.70	19.42	18.24	+ 1.18	+ 0.54
22 35 30	46 58 20	0.0	0.0	0.0	0.0	0.0

Here both the geodetic and the curve of alignment cross to the north side of the curve  $Q$ : the geodetic departing but very slightly to the north. In fact the azimuth of the geodetic at Nicolaëff differs from the true azimuth by only  $0''.152$  by the formula (10). For here the condition shown in equation (11) is very nearly fulfilled.

We may determine the point of intersection of the geodetic with  $Q$  from the equation (13); for the whole distance being  $c$ , and  $x$  the distance of the crossing from Nicolaëff, that equation becomes

$$x^4 + x^3 + x^2 \left( \frac{30}{c^2} - 1 \right) + (x+1) \left( 1 + \frac{30}{c^2} - \frac{120 \cos a}{c^3 \tan u} \right) = 0;$$

or numerically,  $a$  and  $u$  applying to Nicolaëff

$$x^4 + x^3 + 191.97x^2 - 16.46x - 16.46 = 0,$$

the appropriate root of which is  $x = .338$ : this agrees with the last column of the table above, which by interpolation, gives  $x = .339$ .

In the accompanying figure drawn to illustrate this case,

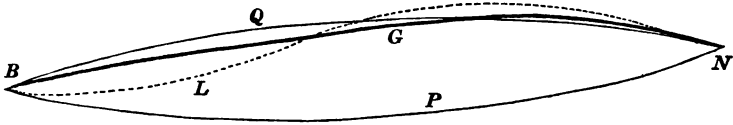

Fig. 24.

the plane curves are indicated by fine lines, the geodesic by a firm line, and the curve of alignment is dotted.

8.

We proceed next to the consideration of the following problem. A geodesic starts from a station  $A$ , in a direction initially at right angles to the meridian there, the latitude of  $A$  being given it is required to determine the latitude and longitude of any point on the geodesic whose distance from  $A$  measured along that curve, is given. Let  $U$  be the reduced latitude of  $A$ ;  $u$  that of a point  $B$  on the geodesic whose distance from  $A$  is  $s$ ;  $\omega$  the longitude of  $B$ . In this case the auxiliary triangle is right-angled, the sides containing the right angle are  $90^\circ - U$  and  $\sigma$ , the third side is  $90^\circ - u$ , and the two other angles are  $\varpi$  and  $a$ . Hence  $\sin u = \sin U \cos \sigma$  and the equations (3) become

$$s = a \int (1 - e^2 + e^2 \sin^2 U \cos^2 \sigma)^{\frac{1}{2}} d\sigma, \tag{15}$$

$$\omega - \varpi = \int \{ (1 - e^2 \cos^2 u)^{\frac{1}{2}} - 1 \} \frac{\cos U d\sigma}{\cos^2 u}.$$

Now put

$$k^2 = \frac{e^2 \sin^2 U}{1 - e^2 \cos^2 U}, \quad 1 - k^2 = \frac{1 - e^2}{1 - e^2 \cos^2 U}; \tag{16}$$

then the first equation may be put in the form

$$\frac{s}{a \sqrt{1 - e^2}} = \frac{1}{\sqrt{1 - k^2}} \int (1 - k^2 \sin^2 \sigma)^{\frac{1}{2}} d\sigma; \tag{17}$$

but we have

$$\begin{aligned}(1 - k^2 \sin^2 \sigma)^{\frac{1}{2}} &= 1 - \frac{1}{2} k^2 \sin^2 \sigma - \frac{1}{8} k^4 \sin^4 \sigma - \frac{1}{16} k^6 \sin^6 \sigma - \dots, \\ \sin^2 \sigma &= \frac{1}{2} - \frac{1}{2} \cos 2\sigma, \\ \sin^4 \sigma &= \frac{3}{8} - \frac{1}{2} \cos 2\sigma + \frac{1}{8} \cos 4\sigma, \\ \sin^6 \sigma &= \frac{5}{16} - \frac{15}{32} \cos 2\sigma + \frac{3}{16} \cos 4\sigma - \frac{1}{32} \cos 6\sigma;\end{aligned}$$

whence, putting

$$\begin{aligned}A &= 1 + \frac{1}{4} k^2 + \frac{13}{64} k^4 + \frac{45}{256} k^6, \\ B &= \frac{1}{4} k^2 + \frac{3}{16} k^4 + \frac{79}{512} k^6, \\ C &= \frac{1}{128} k^4 + \frac{5}{512} k^6, \\ D &= \frac{1}{1536} k^6,\end{aligned}\tag{18}$$

there results

$$\left\{ \frac{1 - k^2 \sin^2 \sigma}{1 - k^2} \right\}^{\frac{1}{2}} = A + B \cos 2\sigma - 2C \cos 4\sigma + 3D \cos 6\sigma;$$

consequently, integrating from  $\sigma = 0$ ,

$$\frac{s}{a \sqrt{1 - e^2}} = A\sigma + \frac{1}{2} B \sin 2\sigma - \frac{1}{2} C \sin 4\sigma + \frac{1}{2} D \sin 6\sigma, \tag{19}$$

and reversing this series we get  $\sigma$  in terms of  $s$ . Thus, from the two sides,  $\sigma$ ,  $90^\circ - U$  of the spherical triangle, we can compute the other angles  $\varpi$  and  $\alpha$ . In order to obtain  $\omega$  from  $\varpi$ , we must develop the second of equations (15). Expanding the radical, we get

$$\omega - \varpi = -\frac{e^2}{2} \cos U \int (1 + \frac{e^2}{4} \cos^2 u + \frac{e^4}{8} \cos^4 u) d\sigma;$$

substituting here for  $\cos^2 u$  its value  $1 - \sin^2 U \cos^2 \sigma$ , and reducing, there is no difficulty in arriving at the following equation:

$$\omega - \varpi = -\frac{e^2}{2} \cos U (A' \sigma - \frac{1}{2} B' \sin 2\sigma + \frac{1}{2} C' \sin 4\sigma), \tag{20}$$

where

$$\begin{aligned}A' &= 1 + \frac{1}{4} e^2 + \frac{1}{8} e^4 - \frac{1}{8} k^2 - \frac{5}{64} k^4, \\ B' &= \frac{1}{8} k^2 + \frac{1}{16} k^4, \\ C' &= \frac{1}{128} k^4.\end{aligned}\tag{21}$$

This completes the determination of  $\omega$ .

## 9.

The results we have just obtained enable us to solve the

more general problem : a geodetic starts from a given point  $A$ , whose reduced latitude is  $u$ , in a given initial azimuth  $a$ , to determine the latitude and longitude of a point  $B$  on the geodetic whose distance from  $A$  measured along that curve is  $s$ . In the solution of this problem we shall omit the terms in  $e^6$  as unnecessary for our purpose. Let  $PHK$  be the auxiliary triangle,  $P$  corresponding to the pole ;  $H, K$ , to  $A$  and  $B$  respectively, so that  $PH = 90^\circ - u$ ,  $PHK = a$ . Drop the perpendicular  $PM$  on  $HK$ , produced if necessary, and let

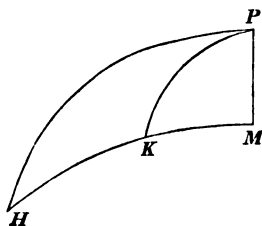

Fig. 25.

$$\begin{aligned} PM &= 90^\circ - U, & HM &= \Sigma, \\ PK &= 90^\circ - u, & HK &= \sigma, \\ HPK &= \varpi, & PKM &= a. \end{aligned}$$

Then we have from the right-angled triangle  $PHM$ ,

$$\begin{aligned} \sin u, &= \sin U \cos \Sigma, \\ \cos a, \cos u, &= \sin U \sin \Sigma, \\ \sin a, \cos u, &= \cos U; \end{aligned}$$

whence  $U$  and  $\Sigma$  are obtained with a check. Now as  $s$  corresponds to  $\sigma$ , so let  $S$  be the linear distance which corresponds to  $\Sigma$ , then by (19) since  $KM = \Sigma - \sigma$ ,

$$\begin{aligned} \frac{S}{a\sqrt{1-e^2}} &= A\Sigma + \frac{1}{2}B \sin 2\Sigma - \frac{1}{2}C \sin 4\Sigma, \\ \frac{S-s}{a\sqrt{1-e^2}} &= A(\Sigma-\sigma) + \frac{1}{2}B \sin 2(\Sigma-\sigma) - \frac{1}{2}C \sin 4(\Sigma-\sigma), \\ \therefore \frac{s}{a\sqrt{1-e^2}} &= A\sigma + B \cos(2\Sigma-\sigma) \sin \sigma \\ &\quad - C \cos(4\Sigma-2\sigma) \sin 2\sigma. \quad (22) \end{aligned}$$

By reversion of this series,  $\sigma$  becomes known, and then by the solution of the spherical triangle  $PHK$  having given the sides  $HK, HP$ , and the angle  $H$ , the third side  $PK = 90^\circ - u$  becomes known, and the angles  $\varpi$  and  $a$ . The value of  $\omega$  follows from (20) in the following manner : first, in the right hand member of this equation put  $\Sigma$  for  $\sigma$ ; secondly, write  $\Sigma - \sigma$  for  $\sigma$ , subtract the second result from the first, then we



have the  $\omega - \varpi$  of our present problem expressed thus

$$\omega - \varpi = -\frac{e^2}{2} \cos U \{A'\sigma - B' \cos(2\Sigma - \sigma) \sin \sigma\}, \quad (23)$$

where the values of  $A'$ ,  $B'$ , are as given in (21).

### 10.

We shall now give the working in full of the following numerical example. Given the latitude of the centre of the Tower of Dunkirk  $51^\circ 2' 8''.41$  as determined by observations with Ramsden's Zenith Sector; the latitude of the vane of the Munster Tower of Strasburg Cathedral  $48^\circ 34' 55''.94$ , and the difference of longitude of these points (*Annales de l'Observatoire Imperial de Paris*, Tome VIII, pp. 256, 320, 356)  $5^\circ 22' 28''.440$ ; to determine the shortest distance between them, and their mutual azimuths. We take the elements of the spheroid,  $a = 20926060$ ,  $b : a = 294 : 295$ , whence

$$\log e^2 = 7.8304712,$$

$$\log e^2 \operatorname{cosec} 2'' = 2.8438663,$$

$$\log a \sqrt{1 - e^2} = 7.3192128.$$

Using only seven place logarithms, we shall omit the terms in  $k^6$ . It is unnecessary to give the calculation for determining the reduced latitudes of the stations, they are found to be

$$u, = 50^\circ 56' 25''.837, \quad \log \cos u, = 9.7994281,$$

$$u', = 48 \ 29 \ 8 \ .406, \quad \log \cos u' = 9.8213873,$$

$$\text{also, } \omega = 5 \ 22 \ 28 \ .440, \quad \log \sin \omega = 8.9715838.$$

In the auxiliary triangle whose sides are  $90^\circ - u$ ,  $90^\circ - u'$ , the included angle is  $\varpi$ —of which an approximate value is  $\omega$ , the true difference of longitude—and the third side  $\sigma$ . The other two angles are the azimuths of the geodetic line at the terminal stations. If  $90^\circ - U$  be a perpendicular dropped on the side  $\sigma$  from the opposite angle, and  $\Sigma$  the distance from the point  $u$ , to the foot of this perpendicular,

$$\sin \sigma \cos U = \cos u, \cos u' \sin \varpi,$$

$$\cos \Sigma \sin U = \sin u, ;$$

put now

$$\kappa^2 = \frac{1}{4} \frac{e^2 \sin^2 U}{1 - e^2 \cos^2 U}, \tag{24}$$

$$A = a \sqrt{1 - e^2} (1 + \kappa^2 + \frac{1}{4} \kappa^4),$$

$$B = a \sqrt{1 - e^2} (\kappa^2 + 3 \kappa^4),$$

$$C = a \sqrt{1 - e^2} (-\frac{1}{8} \kappa^4);$$

then  $s$  being the shortest distance required,

$$s = A\sigma + B \cos(2\Sigma - \sigma) \sin \sigma + C \cos(4\Sigma - 2\sigma) \sin 2\sigma, \tag{25}$$

$$\omega - \varpi = -\frac{e^2}{2} \cos U \left\{ \sigma \left( 1 + \frac{e^2}{4} - \frac{\kappa^2}{2} \right) - \frac{\kappa^2}{2} \cos(2\Sigma - \sigma) \sin \sigma \right\}.$$

The calculation is indirect: we require  $\sigma$ , but

$$\cos \sigma = \sin u, \sin u' + \cos u, \cos u' \cos \omega,$$

therefore we must first obtain  $\varpi$ ; and this implies the knowledge of  $\sigma$ , we therefore adopt the method of approximation. Let  $\varpi_1$  be the first approximation to  $\varpi$ , so that  $\varpi_1 = \omega + \delta\omega$ , where

$$\delta\omega = \frac{e^2}{\sin 2''} \left( \frac{\sigma_0}{\sin \sigma_0} \right) \cos u, \cos u' \sin \omega,$$

$$\cos \sigma_0 = \sin u, \sin u' + \cos u, \cos u' \cos \omega.$$

If  $\sigma_1$  be a first approximation to  $\sigma$ , such that

$$\cos \sigma_1 = \sin u, \sin u' + \cos u, \cos u' \cos \varpi_1,$$

then subtracting this equation from the preceding, we have

$$\sigma_1 - \sigma_0 = \delta\omega \cos u, \cos u' \sin \omega \operatorname{cosec} \sigma_0.$$

In calculating  $\delta\omega$  we may put for the fraction  $\sigma_0 \div \sin \sigma_0$  its approximate equivalent  $\sec^{\frac{1}{2}} \sigma_0$ . It is unnecessary to give the calculation of  $\sigma_0$ , the result is

$$\sigma_0 = 4^\circ 15' 11''.2, \quad \log \sin \sigma_0 = 8.8701852,$$

and the remainder of the work proceeds thus

$\log \sec^{\frac{1}{2}} \sigma_0$	0.00040
$\log e^2 \operatorname{cosec} 2''$	2.84387
$\log \cos u, \cos u' \sin \omega$	8.59240
$\delta\omega = 27''.33$	1.43667
$\log \operatorname{cosec} \sigma_0$	1.12981
$\sigma_1 - \sigma_0 = 14''.41$	1.15888

whence  $\varpi_1 = 5^\circ 22' 55''.77$  and  $\sigma_1 = 4^\circ 15' 25''.6$ . From these we get  $U$  and  $\kappa$  with sufficient approximation,

$\log \cos u, \cos u'$	9.6208154,
$\log \sin \varpi_1 \operatorname{cosec} \sigma_1$	0.1016022,
$\log \cos U$	9.7224176,
$\log \sin U$	9.9291162,
$\log \frac{1}{4} e^2 \sin^2 U$	7.0866436,
$\log (1 + e^2 \cos^2 U)$	0.0008179,
$\log \kappa^2$	7.0874615.

The value of  $\Sigma$  from the equation  $\cos \Sigma \sin U = \sin u$ , is  $\Sigma = -23^\circ 54' 49''.3$ ; it is negative because the perpendicular  $U$  falls on the opposite side of Dunkirk to that in which Strasburg lies. Hence,  $\log \cos (2\Sigma - \sigma) = 9.7885193$ . Then to get  $\varpi$  from (25) the work stands thus, putting for a moment  $N$  for  $e^2 \cos u, \cos u' \sin \varpi_1 \operatorname{cosec} 2''$ ,

$\log N$	1.436877	...	...	...	1.4369,
$\log \sec^{\frac{1}{2}} \sigma_1$	0.000400	$\cos (2\Sigma - \sigma)$	9.7885,		
$+ 27''.3701$	1.437277	$\frac{1}{2} \kappa^2$	6.7864,		
$\log (\frac{1}{4} e^2 - \frac{1}{2} \kappa^2)$	7.03362	$- .0103$	8.0118,		
$+ 0''.0296$	8.47090				

$$\therefore \varpi = \omega + 27''.389 = 5^\circ 22' 55''.829.$$

We have now to compute the third side and remaining angles of the spherical triangle whose sides are complements of  $u$ , and  $u'$ , and  $\varpi$  the included angle. The most correct way of determining the angles is by computing the tangents of half their sum and half their difference, thus we obtain the azimuths

Strasburg at Dunkirk ...  $123^\circ 7' 20''.41$ ,  
 Dunkirk at Strasburg ...  $52^\circ 46' 11''.46$ ;

the last being measured in the direction north towards west. To determine the third side  $\sigma$ , we might proceed in different ways, but owing to the uncertainties of the seventh place of the resulting logarithm there will remain an uncertainty of between two and three units in the third decimal of the seconds. The value as far as seven-place logarithms can give it, is

$$\sigma = 4^\circ 15' 25''.710,$$

There remains no difficulty in computing the length  $s$  from the formula (25) as we are in possession of all the necessary logarithms. We shall therefore merely give the values of the parts of the different terms depending on the different powers of  $\kappa$  :—

TERMS IN	$\sigma$	$\sin \sigma$	$\sin 2\sigma$
	ft.	ft.	ft.
$\kappa^0$	1549559.6	.....	.....
$\kappa^2$	1895.27	1163.56	.....
$\kappa^4$	7.54	4.27	0.14

The sum of these gives  $s = 1552630.4$  with an uncertainty of one or two units in the place of decimals. The true distance is 1552630.300. The astronomical azimuths (computed with precision) are

Strasburg at Dunkirk ... 123° 7' 20".165,  
 Dunkirk at Strasburg ... 52 46 11 .725.

If now by the formula (12), page 130, we compute the differences between the true and geodetic azimuths, we find that to reduce the former to the latter the corrections  $+0''.24$  and  $-0''.26$  are to be applied. Adding these we get again the geodetic azimuths as before.

### 11.

In the particular manner in which we have deduced the equation of the geodetic line, there is this disadvantage that we have lost sight of one of its principal characteristics. Let  $p, q$  be adjacent points on a curved surface; through  $s$  the middle point of the chord  $pq$  imagine a plane drawn perpendicular to  $pq$ , and let  $S$  be any point in the intersection of this plane with the surface. Then  $pS + Sq$  is evidently least when  $sS$  is a minimum, that is, when  $sS$  is a normal to the surface; hence it follows, that of all plane curves joining  $pq$ , when those points are indefinitely near to one another, that is, the shortest which is made by the normal plane. That is to say,

the osculating plane at any point of a geodetic line on a curved surface contains the normal to the surface at that point.

Imagine now three points in space,  $A, B, C$  such that  $AB = BC = c$ ; let the direction-cosines of  $AB$  be  $l, m, n$ , of  $BC$  be  $l', m', n'$ , then  $x, y, z$  being the coordinates of  $B$ , those of  $A$  and  $C$  will be respectively

$$\begin{array}{lll} x-cl, & y-cm, & z-cn, \\ x+c'l, & y+cm', & z+cn', \end{array}$$

and consequently, the coordinates of  $M$ , the middle point of  $AC$  are

$$x + \frac{1}{2}c(l'-l), \quad y + \frac{1}{2}c(m'-m), \quad z + \frac{1}{2}c(n'-n);$$

therefore the projections of  $BM$  on the coordinate planes are

$$\frac{1}{2}c(l'-l), \quad \frac{1}{2}c(m'-m), \quad \frac{1}{2}c(n'-n),$$

and the direction-cosines of  $BM$  are proportional to  $l'-l, m'-m, n'-n$ . If the angle made by  $BC$  with  $AB$  be indefinitely small, then the direction-cosines of  $BM$  are proportional to  $\delta l, \delta m, \delta n$ . Now if  $AB, BC$  be considered two contiguous elements of a geodetic curve, then  $BM$  must be a normal to the surface, and since  $\delta l, \delta m, \delta n$  are in this case represented by

$$d \cdot \frac{dx}{ds}, \quad d \cdot \frac{dy}{ds}, \quad d \cdot \frac{dz}{ds},$$

we have, if  $u = 0$  be the equation of the surface,

$$\frac{\frac{d^2x}{ds^2}}{\frac{du}{dx}} = \frac{\frac{d^2y}{ds^2}}{\frac{du}{dy}} = \frac{\frac{d^2z}{ds^2}}{\frac{du}{dz}}. \quad (26)$$

In the case of the ellipsoid

$$\frac{x^2}{a^2} + \frac{y^2}{b^2} + \frac{z^2}{c^2} = 1,$$

the equations of the geodetic line are

$$\frac{a^2}{x} \frac{d^2x}{ds^2} = \frac{b^2}{y} \frac{d^2y}{ds^2} = \frac{c^2}{z} \frac{d^2z}{ds^2}.$$

For the spheroid, where  $a = b$ ,

$$y \frac{d^2 x}{ds^2} - x \frac{d^2 y}{ds^2} = 0.$$

This being integrated gives

$$y dx - x dy = C ds,$$

which leads to the equation  $r^2 d\omega = C ds$ , as before.

The two equations (26) are equivalent to one only, for of its three members any one can be deduced from the other two by means of the equations

$$\begin{aligned} \frac{du}{dx} dx + \frac{du}{dy} dy + \frac{du}{dz} dz &= 0, \\ \frac{d^2 x}{ds^2} dx + \frac{d^2 y}{ds^2} dy + \frac{d^2 z}{ds^2} dz &= 0. \end{aligned}$$

On the subject of this chapter, see an interesting paper : *Sur les écarts de la ligne géodésique et des sections planes normales entre deux points rapprochés d'une surface courbe*, par F. J. Van den Berg (*Extrait des Archives Néerlandaises*, t. xii).

## CHAPTER VII.

### MEASUREMENT OF BASE-LINES.

THE Geodetic Standards of length of different countries vary in length, in form, and in the material of which they are composed. They are divided into two classes, standards 'à traits' and standards 'à bouts'; in the first, the lines or dots defining the measure are engraved on small disks of silver, platinum, or gold let into the bar; in the second, the bar generally has its extremities in the form of a small cylinder presenting a circular disk, either plane or convex, of hard polished metal, or sometimes of agate, for the contact measurements.

The unit of length, in which by far the greater part of the geodetical measurements in Europe are expressed, is the *Toise of Peru*, a measure, 'à bouts,' of which fortunately there exist two copies (compared with the original and certified by Arago), one made for Struve in 1821, and a second for Bessel in 1823; it has moreover a third representative in Borda's Rod, No. 1. The Standards of Belgium and Prussia are copies of the toise of Bessel; and the Russian Standard, which is two toises in length, is measured from the toise of Struve. The Standard of the Ordnance Survey is ten feet in length and in section a rectangle of an inch and a half in breadth by two and a half in depth, supported on rollers at  $\frac{1}{4}$  and  $\frac{3}{4}$  of its length. The ends of the bar are cut away to half its depth, so that the dots marking the measure of ten feet are in the neutral axis. The standard yard of this country and its copies are bars, an inch square in section, of iron, steel, brass, or copper; the lines defining the yard being in the axis of the

bar. The Standard of the Spanish Geodetical Survey is a bar of four metres in length, constructed of two plates of iron rivetted together in the form of a  $\perp$ . The defining lines are on the upper edge of the vertical bar.

Standards of length are generally provided with thermometers which either lie in contact with the metal or have their bulbs bent downwards so as to enter into cylindrical holes in the upper surface of the bar. It is necessary that the errors of these thermometers be known with considerable accuracy, for an error of a tenth of a degree of temperature corresponds to an error of nearly a millionth of the length of an iron bar and quite that amount in a bronze bar; it is therefore necessary that the error be less than, say,  $0^{\circ}.04$ . These thermometers are compared with standard thermometers from time to time. A standard thermometer for geodetic purposes must be the best workmanship of the best workman, and the residual errors of the division-lines have to be determined from special observations and measurements. These consist in, the determination of the boiling point, that also of the freezing point, the determination of the errors of calibration, and finally, the comparisons together of the standards after the application of the corrections which shall have resulted from the foregoing operations. As all thermometers have an index error which is liable to slow variations in the course of time, it is necessary frequently to redetermine the freezing point by placing the thermometer in broken ice. A convenient method of preparing the ice is to plane it from a block with a rough plane.

In the comparisons of thermometers with one another it is essential that they be held in water. In the comparisons at Southampton the thermometers are carried on a small platform of perforated zinc in the middle of a rectangular vessel measuring 16 inches square by 36 inches in length, thus the thermometers are covered with about seven inches of water when under comparison. There is a piece of mechanism for agitating the water throughout its mass at intervals, so as to prevent any local cooling. The thermometers, lying horizontally, are read by a vertical micrometer microscope from above.

It may be interesting to give here the results of comparisons



of two important standard thermometers; one is that on which depend all the comparisons of standards made at Southampton, the other is a standard used for similar purposes in India. An examination of the boiling and freezing points of these thermometers made at the time of the comparisons show that the former requires the correction  $-0^{\circ}.010 (t-32^{\circ}) - 0^{\circ}.41$  where  $t$  is the thermometer reading, and the latter  $-0^{\circ}.010 (t-32^{\circ})$ . The calibration corrections given in the second and fifth columns result from a large number of micro-meter measurements of the capacities of the different portions of the tubes. The first and fourth columns contain each the mean of five simultaneous readings of the thermometers in water; the room in which the comparisons were made having been kept at a temperature not differing more than a couple of degrees from that of the water.

ORDNANCE SURVEY STANDARD.			INDIAN SURVEY STANDARD.		
Reading.	Cal. Corr.	App. Error.	Reading.	Cal. Corr.	App. Error.
97.84	- 0.032	+ 0.005	97.46	- 0.073	- 0.005
92.58	- 0.062	0.000	92.11	- 0.005	0.000
87.61	- 0.039	+ 0.010	87.15	- 0.012	- 0.010
82.72	- 0.095	- 0.005	82.25	- 0.020	+ 0.005
77.92	- 0.116	0.000	77.43	- 0.044	0.000
72.56	- 0.106	- 0.015	72.03	+ 0.046	+ 0.015
67.70	- 0.083	+ 0.010	67.17	+ 0.029	- 0.010
62.64	- 0.068	- 0.005	62.15	+ 0.035	+ 0.005
57.95	- 0.059	- 0.015	57.48	+ 0.036	+ 0.015
52.63	- 0.041	- 0.020	52.20	+ 0.016	+ 0.020

The 'apparent error' in the third and sixth columns is the difference between the individual readings after correction and their mean.

The standards when boiled were kept in a horizontal position. If  $T$  be the reading of the thermometer,  $B$  that of the barometer (reduced to  $32^{\circ}$ ) at the same moment, then the error  $E$  of the boiling point is

$$E = T - 212^{\circ} + 1.680 (\mathfrak{B} - B),$$

where  $\mathfrak{B}$  is Laplace's standard atmospheric pressure, namely in

latitude  $\phi$ , and at the height of  $h$  feet above the sea,

$$\mathfrak{z} = 29.9215 \text{ in.} + .0785 \cos 2\phi + .0000018 h.$$

This is 0.760 of a metre in the latitude of  $45^\circ$  or 30.000 inches at the equator; in either case at the level of the sea. A few minutes after boiling, the thermometers are placed in ice for the determination of the index error.

But it is not sufficient to define a measure as the distance between two marks on the upper surface of a bar of metal at a given temperature, for the bar is not a rigid but an elastic body, which changes its form according to the manner in which it is supported. If an uniform elastic rod be supported at its centre in a horizontal position, the whole of the material above the 'neutral axis' is in a state of tension, while the lower half is compressed; and an exactly opposite state exists if the rod is supported at its ends. Suppose the bar to be of length  $a$ , and its section a rectangle of breadth  $h$  and depth  $k$ : let  $w$  be its weight, and  $\alpha$  the small quantity by which the bar would be either lengthened or shortened by an extending or compressing force equal to  $w$ . Then, supposing the bar to be in its unconstrained state perfectly straight, if  $\rho$  be the radius of curvature of the axis at any point  $q$  when the bar is slightly bent in the plane of  $k$ , the sum of the moments of the elastic forces developed in the transverse section of the bar at that point may be shown to be equal to  $\frac{w a k^2}{12 a \rho}$ , and this must be equal to the sum of the moments of the external forces tending to bend the bar round  $q$ .  
Let  $P, P'$  be the points of support

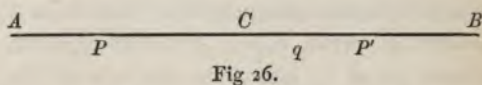

Fig 26.

of the rod at the distances  $b, b'$  from  $C$ , the middle point of  $AB$ . Let the equation of the rod, or of its axis rather, be expressed in rectangular coordinates  $x, y$ , the axis of  $x$  passing through the points of support, and  $x = 0$  corresponding to the point  $C$ . Now the external forces tending to bend  $qB$  round  $q$  are its own weight and the reaction of the support at  $P'$ , and the sum of the moments of these forces is

$$= \frac{b w}{b + b'} (b' - x) - \frac{w}{2 a} (\frac{1}{2} a - x)^2.$$

Hence, the condition of equilibrium is

$$\frac{ak^2}{6a} \cdot \frac{1}{\rho} = \frac{2bb'}{b+b'} - \frac{a}{4} + \frac{b'-b}{b'+b}x - \frac{x^2}{a}.$$

It is easy to see from this that there can be no points of inflection unless  $b+b' > \frac{1}{2}a$ . That is, unless the supports are further apart than half the length, the whole bar will be convex upwards. This equation however does not refer to the portion  $P'B$  of the bar; for that portion we find

$$\frac{ak^2}{6a} \frac{1}{\rho} = -\frac{a}{4} + x - \frac{x^2}{a}.$$

Now since the flexure of the bar is really very small, we may omit  $\frac{dy^2}{dx^2}$ , and putting  $\frac{1}{\rho} = \frac{d^2y}{dx^2}$  and  $\mu = \frac{6a}{ak^2}$ , the above equations become

$$\frac{1}{\mu} \frac{d^2y}{dx^2} = \frac{2bb'}{b+b'} - \frac{a}{4} + \frac{b'-b}{b'+b}x - \frac{x^2}{a}, \quad (1)$$

$$\frac{1}{\mu} \frac{d^2y}{dx^2} = -\frac{a}{4} + x - \frac{x^2}{a}, \quad (2)$$

from whence we obtain by two integrations the equation of the axis.

The distance between two points on the upper surface of the bar at its extremities will be variable, not only from the curvature of the neutral axis shortening its horizontal projection, but from the compression or extension of the upper surface. The change of length arising from the first is generally quite inappreciable, that from the second is large, a source of error unless guarded against. Imagine normals drawn at  $A$ ,  $C$ , and  $B$  to the axis of the bar in its vertical plane, the angle between the normals at  $C$  and  $B$ —supposed to converge upwards—being  $\theta$ , and let  $\theta'$  be the angle between the normals at  $A$  and  $C$ , then the points on the upper surface have been drawn together by the amount  $\frac{1}{2}k(\theta + \theta')$ . Now

$$\begin{aligned} \frac{1}{\mu} \theta &= \int_0^{b'} \left( \frac{2bb'}{b+b'} - \frac{a}{4} + \frac{b'-b}{b'+b}x - \frac{x^2}{a} \right) dx + \int_{b'}^{\frac{a}{2}} \left( -\frac{a}{4} + x - \frac{x^2}{a} \right) dx \\ &= b' \frac{bb'}{b+b'} - \frac{a^2}{24}, \end{aligned}$$

with a similar expression for  $\theta'$ ; thus the contraction of the upper surface is, if we put  $aa = k\epsilon$ ,

$$\frac{1}{2} k (\theta + \theta') = 3\epsilon \left( \frac{bb'}{a^2} - \frac{1}{12} \right).$$

For a bar supported at its centre  $b = b' = 0$ , and the surface is *extended* to the amount  $\frac{1}{4}\epsilon$ . For a bar supported at its extremities the *contraction* is  $\frac{1}{2}\epsilon$ , being double the amount of the extension in the previous case. If supported on rollers at one-fourth and three-fourths of its length, the upper surface is extended  $\frac{1}{18}\epsilon$ . But if we place the supports so that

$$b = \frac{a}{2\sqrt{3}} = b',$$

the distance between the extreme marks on the upper surface will be the same as if the bar were straight; a particular case of a more general theorem due to the Astronomer Royal (*Memoirs of the Royal Astronomical Society*, vol. xv).

The variations of length to which the upper surface of a bar is thus liable have given rise to the practice of engraving the lines indicating the measure on surfaces (gold, silver, or platinum disks) in the neutral axis.

At the Ordnance Survey Office, Southampton, is a building specially constructed for comparisons of standards. The inner room, measuring 20 feet by 11, with thick double walls, is half sunk below the level of the ground, and is roofed with 9 inches of concrete. An outer building entirely encloses and protects the room from external changes of temperature; so that diurnal variations are not sensible in the interior. Along one wall of the room are three massive stone piers on deep foundations of brickwork; the upper surfaces of these stones (which are  $4\frac{1}{2}$  feet above the flooring on which the observer stands) carry the heavy cast-iron blocks which—projecting some seven inches to the front over the stones—hold in vertical positions the micrometer microscopes under which the bars are brought for comparison. Each micrometer microscope is furnished with an affixed level for making its axis vertical; one division of the micrometer is somewhat less than the millionth of a yard.

It is a most essential point in the construction that the

foundations which carry the stone piers—the supports of the bars under observation—and the flooring on which the observer stands, are *separate*; thus, no movement made by the observer communicates any motion either to the bars or to the microscopes.

The illumination of the disks (on the bar) which bear the lines or dots indicating the measure, is effected by the light of a candle placed some ten inches behind each microscope: the light of the candle passes through a large lens which forms an image of the flame on the disk, giving abundant illumination with a minimum of heat.

When two bars are to be compared they are placed generally in the same box side by side and close together; each bar rests immediately on rollers to which a fine vertical movement can be communicated. The first adjustment is to level one of the bars and bring the microscopes over the terminal dots; the microscopes are then made truly vertical, brought perfectly to focus, with the collimation axis closely over the dots. It is usual to arrange a pair of bars at least twenty-four hours before any comparisons are made, so that a steady equality of temperature may have been obtained. The bars are visited for the purpose of comparison three or four times a day; all adjustments are frequently put out and renewed, and the bars themselves are made to interchange places so as to avoid constant error, the possibility of which requires to be ever kept in mind. The observations made at one visit and constituting 'a comparison' are these:—(1) The thermometers in the bars are read; (2) the bar *A* being under the microscopes the lines or dots at either end are bisected and the micrometer read; (3) the second bar *B* is brought under the microscopes and read; (4) *B* is thrown out of focus, brought back again, and read again; (5) *A* is observed a second time after renewed focussing; (6) the thermometers are read again.

As no artificial temperature is used, it is the practice to compare bars when the temperature is near  $62^{\circ}$ , which is the standard temperature for standards of length in this country, and again when it is much lower, so as to eliminate the differences of expansion. The absolute rates of expansion have been determined for but few standards, although an elaborate

apparatus exists in the comparison room just described for the determination of absolute expansion of ten feet bars. The great point in this apparatus is the possibility of maintaining a bar at a high temperature, such as  $90^{\circ}$  or  $100^{\circ}$ , without perceptibly heating the room; then comparing, if for instance there be two bars  $A, B$ ;  $A$  hot with  $B$  cold; and again,  $B$  hot with  $A$  cold. Each bar lies closely between two long narrow tanks of copper; the cold bar has either ice or cold water in its tanks, while those of the hot bar are continuously supplied with hot water by flexible feed pipes from a large cistern maintained steadily at the required temperature outside the building; the hot water continually running away from the tanks and passing out of the room by flexible waste pipes. A special mechanism permits of the rapid interchange of the bars, each with its tanks, under the microscopes.

The following coefficients of expansion were obtained for four ten feet bars from 6500 micrometer and thermometer readings:—

Indian Standard: Bronze ...	$0.0000098277 \pm .0000000057,$
"    "    Steel ...	$0.0000063478 \pm .0000000056,$
Ordnance Survey: Iron ...	$0.0000064729 \pm .0000000031,$
"    "    Iron ...	$0.0000064773 \pm .0000000033.$

In expressing micrometer measurements and their probable errors it is convenient to use as unit the millionth of a yard. With this unit the probable error of a single micrometer bisection of a good line is, for an expert observer,  $\pm 0.25$ , but for a coarse or ill defined line, or a dot, it may be considerably more. The probable error of a single comparison of two bars depends on their length as well as on the quality of the lines: for a yard it varies from  $\pm 0.35$  to  $\pm 0.66$ ; for a bar of 10 feet it may be between  $\pm .65$  and  $\pm 1.30$ .

The micrometer observations in the comparisons of standards are affected to a small extent by 'personal error': that is to say, what one observer may consider a 'bisection', another observer may think to be in error. What is technically termed a bisection is the placing of the spider lines of the micrometer centrally over the line to be observed; or the adjusting the parallel micrometer lines so that the engraved

line on the bar may appear equally distant from them. Thus, if one observer make a bisection, and two others were to make a drawing of what they see, they might produce such results



Fig. 27.

as *a* and *b*, fig. 27, where the fine lines are the micrometer lines, and the thick line is the engraved line on the bar. There is however not altogether a constant difference between two observers; it is only on some lines that there is any personal error, and then it is but a very small quantity. The difference of opinion seems to arise from some inequalities about the edges of the engraved line. Those lines which bring out the greatest amount of personal error are fine or faint lines; the

best lines for observing are those whose edges are clean and parallel. In the platinum metre of the Royal Society the lines are very fine and difficult to observe.

When the observations to be made with a micrometer microscope are such that a large number of divisions have to be measured, involving it may be perhaps several revolutions of the micrometer, it is absolutely necessary to investigate the errors of the screw. As the measurement of any space on a scale is affected by the error of focal adjustment, it is necessary in measuring spaces for the determination of the values of the screws of micrometers that the focus be readjusted at every measure. In the principal micrometer microscopes of the comparison apparatus at Southampton the value of a division of the micrometer is for the one microscope  $0.79566 \pm .00008$ , and for the other  $0.79867 \pm .00009$ ; these values are not sensibly affected by temperature. The probable errors in the measurement of *n* thousand divisions are for the respective microscopes

$$\pm \sqrt{.187n^2 + .20} \quad \text{and} \quad \pm \sqrt{.349n^2 + .20},$$

the larger quantity arising from that microscope having less perfect definition.

In the case of standards, 'à bouts,' the surfaces of the circular terminating disks should be slightly convex; but the radius

of curvature of these surfaces is a disposable constant, which may be turned to account in the following manner. The true length, or, which is the same, the maximum length of the bar, is the distance of the centres  $C, C'$  of the two disks, these, as well as the corresponding centres of curvature being in the axis of the bar. If the measure be made from any point  $P$  on the surface of one disk to a point  $P'$  on the other disk, the distance  $PP'$ , if taken as the length of the bar, will be in error. Now we may take the radius of curvature  $\rho$  of either disk such that the chance error consequent on measuring between any other than the centre points of the disks may be a minimum. Let  $2a$  be the length of the bar,  $2c$  the diameter of the small disks. Take the centre point of the axis of the bar as the origin of coordinates, the axis itself being that of  $z$ , if  $r, r'$  be the distances of  $P, P'$  from the axis, we may put for the coordinates of those points

$$\begin{aligned}x &= r \cos \theta, & y &= r \sin \theta, & z &= a - \frac{r^2}{2\rho}, \\x' &= r' \cos \theta', & y' &= r' \sin \theta': & z' &= -a + \frac{r'^2}{2\rho}.\end{aligned}$$

One of these angles, as  $\theta'$ , we may put = 0. Then

$$PP'^2 = r^2 + r'^2 - 2rr' \cos \theta + \left(2a - \frac{r^2 + r'^2}{2\rho}\right)^2;$$

$$\therefore 2a - PP' = \frac{1}{4a} \left(2 \frac{a}{\rho} (r^2 + r'^2) - r^2 - r'^2 + 2rr' \cos \theta\right),$$

which is the error of the measurement. The sum of the squares of these errors for all pairs of points is

$$\begin{aligned}\frac{1}{16a^2} \int_0^c \int_0^c \int_0^{2\pi} \left\{ (r^2 + r'^2) \left(\frac{2a}{\rho} - 1\right) + 2rr' \cos \theta \right\}^2 dr dr' r r' d\theta \\= \frac{\pi c^8}{192a^2} \left\{ 3 + 7 \left(\frac{2a}{\rho} - 1\right)^2 \right\},\end{aligned}$$

which is a minimum when  $\rho = 2a$ ; that is, the centre of curvature for either disk must be at the other end of the bar.

In order that the triangulation of the continental countries of Europe might be put in connection with the triangulation of England, the Government of this country, at the suggestion of General Sir Henry James, then Director of the Ordnance



Survey, invited the Governments of Russia, Prussia, Belgium, Spain, Austria, and also the United States of America to send their standards to Southampton to be compared. The invitation in each case was complied with, and an account of the comparisons, which are of the highest importance to Geodesy, will be found in two papers in the *Philosophical Transactions* for 1866 and 1873: fuller details are given in the work entitled *Comparisons of the Standards of Length of England, France, &c.*, by Col. Clarke, R.E.

The following are some of the principal results of these comparisons, the Old English capitals representing the true lengths of the Yard, Toise, Metre, and Klafter:—

NAME OF STANDARD.	STAND. TEMP.	ACCREDITED LENGTH <sup>1</sup> .	LENGTH IN ENGLISH YARDS.
		l.	
Belgian Toise ... ..	61.25	℄ - 0.00100	2.13150851 ℄
Prussian Toise ... ..	"	℄ - 0.00099	2.13150911 "
Russian Double Toise ...	"	2 ℄ - 0.00560	4.26300798 "
		mm.	
Spanish 4 Metre Bar. ...	"	4 ℣ + 0.40710	4.37493562 "
Platinum Metre, Roy <sup>1</sup> . Soc <sup>2</sup> .	32.0	℣ - 0.01759	1.09360478 "
		l.	
Pulkowa copy of Klafter ...	61.25	℔ - 0.00029	2.07403658 "
Milan copy <sup>2</sup> K <sub>1.1</sub> ... ..	"	℔ - 0.00580	2.07401462 "
" " K <sub>1.11</sub> ... ..	"	℔ - 0.00000	2.07402990 "

The first three lines in this table afford, from many thousands of observations, three entirely independent values of the toise. The greatest divergence of any one of the three values from their mean is but half a millionth of a toise. Then the toise being known, the length of the metre follows by means of the definition  $443296 \text{ ℄} = 864000 \text{ ℣}$ . A further check on this value of the metre is afforded by the Spanish bar, of which the length, as taken from Borda's rod No. 1, is  $4.0004071 \text{ ℣}$ .

<sup>1</sup> The 'line' represents the 864th part of the Toise, or of the Klafter.

<sup>2</sup> The Milan copy of the Klafter of Vienna has two measures of the Klafter laid off on it, one on its upper surface defined by dots 1. 3, the other on its under surface by dots marked by Roman numerals I. II.

According to the observations at Southampton the Spanish bar is 4.0004052  $\mu$ , a difference of only half a millionth of the length.

The final results are these :

$$\mathcal{C} = 2.13151116 \mathcal{M},$$

$$\mathcal{M} = 1.09362311 \mathcal{M},$$

$$\mathcal{M} = 2.07403483 \mathcal{M}.$$

The lengths adopted for measured bases have varied according to the circumstances of each case. That of Bessel in East Prussia, as we have seen, was but little more than a mile in length—whereas the base line of Ensisheim in France measured by Col. Henry was 11.8 miles. Between these limits they may be found of all lengths. In India, with the exception of the line at Cape Comorin of 1.7 miles, the remaining nine bases are between 6.4 and 7.8 miles. In the Spanish triangulation are several short bases of about a mile and a half; the principal base, near Madrid, is 9.1 miles long, and there is one of just a mile in length in the Island of Ivica.

In selecting ground for a base measurement, the conditions to be secured are that it be fairly even, and free from obstacles, and that the extremities should not only be mutually visible, but command views of more distant stations of the triangulation, so that the sides of the triangles, commencing with

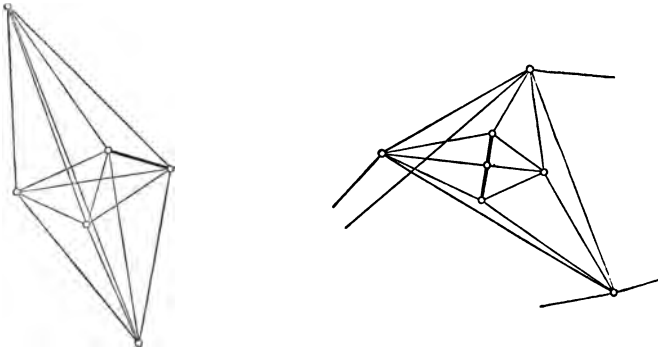

Fig. 28.

the base, may gradually increase. The first of the annexed diagrams shows the connection of the base measured at

Epping, Maine, United States, with the adjoining trigonometrical stations. The second shows the connection of the base measured near Ostend by General Nerenburger in 1853.

The knowledge of the length of a metal bar at any moment involves three distinct matters: the length at some specified temperature, the coefficient of expansion, and the temperature of the bar at the moment in question. The first is known by repeated comparisons with the Standard; the second can be obtained only from special experiments; the exact temperature of a bar at any moment can only be inferred from the indications of thermometers in contact with it, involving the assumption that the temperature of the bar is the same as that of the mercury in the thermometers. But experiments have shown that we may be deceived in this.

To evade the temperature difficulty two different forms of construction have been adopted, one—that of Borda—where the measuring bar is composed of two rods of quite different rates of expansion, forming a metallic thermometer; the other that of Colby, where by a simple mechanical arrangement two rods of different expansions are made to present two points at an invariable distance.

Whatever be the apparatus used, it is essential that the measure be confined strictly to the vertical plane containing the extremities of the base; and that the deviations, in the vertical plane, of the line actually measured or traced by the individual bars from a straight line, be precisely measured. The first part of this sentence requires however to be qualified—it is sometimes necessary that two or more segments of a base be not absolutely in the same straight line; this is no disadvantage when the angles the different parts make with one another are known. But in each segment the measure must be in one vertical plane.

As a preliminary operation to the measurement of a base it is usual after getting an accurate section of the line by spirit levelling, to measure the distance in an approximate manner. In making this measure one or two or more points are selected in positions convenient for dividing the base into segments. The selected points are subsequently adjusted into the line of the base with the utmost precision by means of a theodolite

or transit instrument erected at either or both extremities; or if they be not absolutely in the line, angles measured at them indicate their real position. These intermediate points are sometimes preserved in the same permanent manner as the terminal points of the base, namely, by a fine mark on a massive block of stone set in brickwork. The mark itself may be a microscopic cross drawn on the surface of a piece of brass cemented into the stone, or it may be a dot on the end of a piece of platinum wire set vertically in lead run into a hole in the stone. In some cases the ends of a base have been indicated by small vertical facets.

A more detailed aligning of the base follows. By means of the theodolite or transit instrument over the ends and intermediate points, pickets are driven into the ground at regular intervals; each picket carries a fine mark indicating exactly the line of measurement. As the errors resulting from faulty alignment do not tend to cancel, being always of the same sign, this operation always receives the last degree of care.

In attempting to give a description of the apparatus and processes for measuring base lines it would be quite beyond the purpose of this work to enter into the details which are very complex. Abundant information can be obtained from such works as the following:—*Compte rendu des opérations . . . a la mesure des bases géodésiques Belges*, Bruxelles, 1855; *Triangulation du Royaume de Belgique*, Bruxelles, 1867; *Expériences faites avec l'appareil a mesurer les bases*, Paris, 1860; *Base Centrale de la triangulation géodésique d'Espagne*, Madrid, 1865; the *Account of the measurement of the Lough Foyle base*, London, 1847; and other works.

In the apparatus used by the Russian Astronomer F. W. Struve in the measurement of base-lines, there were four bars, each two toises in length, of wrought iron. One end of each bar terminates in a small steel cylinder coaxial with the bar, its terminal surface being slightly convex and highly polished, the other end carries a contact lever of steel connected directly with the bar. The lower arm of this lever terminates in a polished hemisphere, the upper arm traverses a graduated arc also rigidly connected with the bar. When an index line at the end of the longer arm points to a certain central division on

the graduated arc, the bar is at its normal length, but its length is also known corresponding to any reading of the arc. The annexed figure shows the contact lever. In measuring, the bars are brought into contact, which is maintained by a spring acting on the lever. Each bar held at two points is protected within a box from which its extremities project; it is further protected from variations of temperature by being wrapped in many folds of cloth and raw cotton. Two thermometers, whose bulbs are let into the body of the bar, indicate its temperature.



Fig. 29.

The end of a day's work is marked by driving into the ground under the advanced end of the front bar a very large iron picket to the depth of two feet. This picket carries an arm with a groove, in which slides, and can be fixed, a metallic cube having a fine mark on its upper surface. The projection of the end of the bar over this mark is effected by means of a theodolite established as a transit instrument at a distance of 25 feet in a direction perpendicular to the base.

Struve investigates very carefully for his several bases the probable errors arising from the following causes. 1. Errors of alignment. 2. Errors in the determination of the inclinations of bars. 3. Error in the adopted length of the working standard. 4. Error in the adopted lengths of the measuring bars. 5. Error in reading the lever index and of the graduation. 6. Personal errors of the observers. 7. The uncertainty of temperature. This last was subdivided into four headings, (1) uncertainty in the expansion of the standard, (2) uncertainty in the expansion of the measuring bars, (3) uncertainty of temperature during the comparisons of the bars and standard, (4) uncertainty of the mean temperature at which the base was measured.

The probable errors of the seven bases measured with these bars range from  $\pm 0.73\mu$  to  $\pm 0.91\mu$ , where  $\mu$  is a millionth part of the length measured.

The remainder of the Russian bases, three in number, were measured by the apparatus of M. de Tenner. In this system

the measuring bar is of iron, and the intervals between bars in the line is measured by a fine sliding scale. The accuracy of these bases is not so great, the probable errors are about  $\pm 3.1\mu$ .

Borda's measuring rods have been already described in connection with the work of Delambre. In Bessel's system the platinum and copper of Borda are replaced by iron and zinc, and the intervals are measured with a glass wedge. The annexed figure shows the small interval forming the metallic thermo-

meter. The upper or zinc rod terminates at either end in a horizontal knife edge. The small piece affixed to the upper surface of the iron rod has two vertical knife edges,

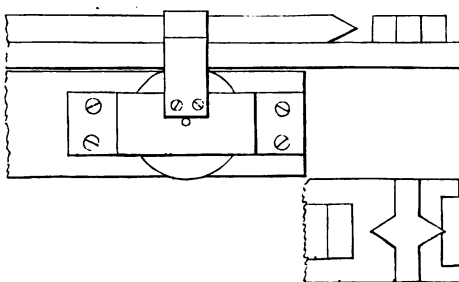

Fig. 30.

end of the measuring rod, while the other, or inner knife edge, forms with horizontal edge of the zinc the small interval which constitutes the thermometer.

The rods are supported on seven pairs of rollers carried by a bar of iron, the whole being protected in a case from which the contact ends of the rod project. A small longitudinal movement of the rods by rolling on the supporting rollers is communicated to them by means of a slow motion screw of which the milled head projects from the box.

The glass wedge has a length of about four inches, being 0.07 of an inch thick at the smaller end and 0.17 at the larger end; it has engraved on its face 120 division lines 0.03 of an inch apart.

Denote by  $\tau$  the standard temperature to which the measurements and comparisons are reduced. Let the lengths of the zinc and iron rods at this temperature be  $l, l'$ , then at any other temperature they will be thus expressed,

$$L = l + e(t - \tau), \quad L' = l' + e'(t - \tau).$$

Let the difference between them, as measured by the wedge, be  $i$  at the temperature  $t$ , then  $i = l' - l + (e' - e)(t - \tau)$ , and eliminating  $t - \tau$ ,

$$L' = \frac{l e' - l' e}{e' - e} + \frac{e' i}{e' - e};$$

that is, the length of the rod is expressed in the form  $A + B i$ , where  $A$  and  $B$  are constants to be determined for each compound rod. The lengths of the rods may be written thus

$$L_1 = l + x_1 + a y_1,$$

$$L_2 = l + x_2 + b y_2,$$

$$L_3 = l + x_3 + c y_3,$$

$$L_4 = l + x_4 + d y_4.$$

The small differences of the bars represented by the quantities  $x$ , the sum of which is zero, and the values of the thermometric coefficients  $y$ , are determined by comparisons of the rods *inter se*. From these comparisons a system of eight equations is deduced by the method of least squares from which the  $x$ 's and  $y$ 's are obtained. Finally, the comparison of one of the rods with the standard gives  $l$ .

The length of the base line is finally expressed in the form

$$L = n l + \alpha x_1 + \beta x_2 + \gamma x_3 + \delta x_4 + \alpha' y_1 + \beta' y_2 + \gamma' y_3 + \delta' y_4.$$

The probable error of Bessel's base was found to be  $\pm 2.2 \mu$ .

Bessel's apparatus was used in the Belgian bases near Beverloo and Ostend, measured (1852, 53) with every imaginable precaution by General Nerenburger. The mode of terminating a day's work by the use of the plummet, a weak point in Bessel's base, was replaced by the following procedure. The exact end of a day's work being decided in advance, a mass of brickwork was built from a depth of a couple of feet up to the surface of the ground; in this was built a cast-iron frame presenting a surface flush with the brickwork. Another frame of iron two feet high, and which could be screwed to the former or removed at pleasure, carried on its upper surface a groove in which a small measuring rule 14 inches long was free to slide in the line of the base and to be clamped where required. This rule terminated in a vertical knife edge at one—the advanced—edge, and in a horizontal knife edge at the

following end. When the vertical knife edge of the last bar, at the end of the day's work, arrived near this apparatus, the small rule was set and clamped so as to leave between it and the measuring bar the usual small interval for measurement with the glass wedge. On the following morning the work was resumed by starting from the other end of the rule—which thus formed a part of the base measure.

The mean error of the base near Beverloo, 2300 metres in length, was  $\pm 0.59 \mu$ ; that of the Ostend base, 2488 metres, was  $\pm 0.45 \mu$ ; these at least are the quantities as computed.

In Colby's Compensation Apparatus the component bars are of iron and brass, 10 feet in length, firmly connected at their centres by a couple of transverse cylinders. At either extremity is a metal tongue about six inches long, pivoted to both bars in such a manner as to be perfectly firm and immoveable, while yet not impeding the expansion of the bars. A silver pin let into the end of each tongue carries a microscopic dot, marked  $c, c'$  in the figure. The letters  $ab, a'b'$  refer to

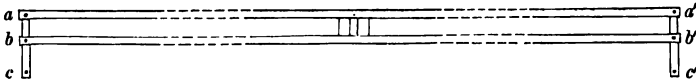

Fig. 31.

the axes of the pivots shown by dots. To explain how the distance  $cc'$  is independent of temperature, let  $\alpha, \beta$  be the rates of expansion of the brass and iron bars  $aa', bb'$ , respectively. By construction,

$$ac : bc = \alpha : \beta = a'c' : b'c'.$$

Now the centres of the bars being fixed, let a certain increase of temperature imparted to each bar cause  $a$  to move off to the left the small distance  $ai$ , while  $b$  is carried in the same direction the amount  $\beta i$ . It is clear that the movement of  $c$  is zero; that is, the distance of the dots  $cc'$ , exactly ten feet, is invariable.

In order to ensure the proper action of this mechanism it is necessary that the radiation and absorption of heat by the bars be equal; this is effected by clouding and varnishing the



surfaces until by experiment the rates of heating and cooling are found to be the same.

The bars, resting immediately upon a pair of rollers, are protected in a stout wooden box, and prevented from longitudinal motion by a pin passing up between the cylinders. The boxes are supported on tripods and trestles in the usual manner.

The interval between two bars in measuring is six inches, measured by a 'compensation microscope' constructed thus: two microscopes of two inches external focal length, lying parallel and six inches apart, are connected by two bars, one of brass and the other of iron, in such a manner that the outer foci are compensated points at six inches distance. Through

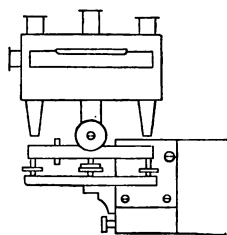

Fig. 32.

the centres of the two bars passes a third microscope parallel to the others; this is a telescopic microscope, that is, it has a focal adjustment to suit vision of points at slightly different distances. Moreover it is provided with object glasses of various lengths, the collimation of which is an important matter.

The three combined microscopes revolve round the axis of the centre one in a tube to which is affixed below, a tripod with levelling screws. Motion is communicated to the compound microscope in two horizontal directions, i.e. in the line of the base and perpendicular thereto, by two slow motion screws, seen in the drawing Fig. 32. The tripod is supported, when the microscopes are being used, on a three-armed grooved stand affixed to the end of the bar box. On one side of the compensation microscope is affixed a level, on the other a small telescope moveable in a vertical plane for alignment.

The end of each series of six bars in the measurement is transferred to the ground by means of a 'point carrier,' which is a massive triangular plate of cast-iron having attached to its surface, or at a height above it that may be varied as required, an adjustable horizontal disk with a fine point engraved on it. This point is adjusted to bisection in the focus of the advanced telescopic microscope.

With this apparatus two bases have been measured in this country; one in Ireland, in the county of Londonderry; the other on Salisbury Plain.

In India ten bases have been measured on this system.

It must be admitted that these bars—and especially in India—have not given unqualified satisfaction. In consequence of the inaccuracies of the apparatus, detected in the work in India, the ordinary practice was departed from in the base at Cape Comorin, and instead of the usual length, a line of a fourth of the length was selected and measured four times. By this means a value of the probable error of measurement was obtained which could have resulted from no other process.

The line runs north and south, and was divided by three intermediate points into nearly equal segments. In consequence of facts that had come to light regarding the thermal inequalities of the components of the compensation bars, two of the measurements were made with the brass bar to the west, the other two with the brass to the east. Each measurement was further made dependent solely upon comparisons with the standard made on days immediately preceding and following that measurement. The results, in feet, are shown in the following table:—

BASE AT CAPE COMORIN,  
1869,

NO. OF MEASURE.	SEGMENT I.	SEGMENT II.	SEGMENT III.	SEGMENT IV.	TOTAL LENGTH.
First	2205.186	2205.166	2205.169	2297.083	8912.604
Second	.180	.156	.163	.065	.565
Third	.175	.156	.162	.075	.568
Fourth	.176	.162	.164	.071	.573
Means	2205.179	2205.160	2205.164	2297.074	8912.578

It is important to remark that the 'compensation' principle was not in this case relied on. The components of one of the bars were each supplied with two thermometers which were regularly read during the measurement.

From these remeasurements the inference is that the probable error of measurement of a base-line is about  $\pm 1.5 \mu$ .

The United States Coast Survey Base Apparatus devised by Professor Bache in 1845 combines the principle of Borda's measuring rods, the compensation-tongue of Colby's, and the contact lever of Struve's. The cross sections of the component bars are so arranged, that while they have equal absorbing surface, their masses are inversely as their specific heats, allowance being made for their difference of conducting power. The components are placed edgewise, the iron above and the brass below, firmly united together at one end. The brass bar, which has the largest cross section, is carried on rollers mounted in suspending stirrups; and the iron bar rests on small rollers which are fastened to it and run on the brass bar. Supporting screws through the sides of the stirrups retain the bars in place. The connection between the free

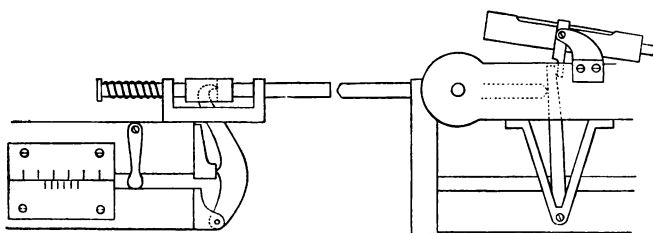

Fig. 33.

ends of the component bars is the lever of compensation which is pivoted to the lower bar. A knife edge on the inner side of this lever abuts against a steel plane on the end of the upper or iron bar. At its upper end this lever terminates in a knife edge facing outwards in a position corresponding to the compensation point in Colby's bars. The knife edge presses against a collar on a sliding rod moving in a frame affixed to the iron bar above; the sliding rod is drawn backwards by a spiral spring through which it passes and keeps the lower knife edge of the lever pressed with constant pressure against the iron bar. The sliding rod terminates in an agate plane for contact. A vernier attached to this end of the bar gives their difference of length as a check on the work.

At the other end, where the bars are united, there is a corresponding sliding rod terminated outwardly in a blunt

horizontal knife edge; the inner end abuts against a contact lever pivoted below, this lever when pressed by the sliding rod comes in contact with the short tail of a level, mounted on trunnions and not balanced; for a certain position of the sliding rod the bubble comes to the centre, this position gives the true length of the measuring bar. It is obvious that this is an exceedingly delicate mode of measuring; the pressure of the contacts is moreover always the same.

At this end of the apparatus there is also a sector for indicating the inclination of the bar in measuring, and it is indeed to the arm of this sector that the contact lever and level are attached. For perfect understanding of these compensation bars, reference must be made to a description and figures contained in the *U. S. Coast Survey Report*, 1873.

The bars are protected in a spar-shaped double tin tubular case; the air chamber between the two cases being a great check on the variations of temperature. The tube is strengthened by diaphragms and a vertical and a horizontal sheet of iron running the whole length. The ends are closed, the sliding rod only projecting at either extremity. The tubes are painted white externally; they are mounted on a pair of trestles; and there is a special apparatus for making the contacts with very great delicacy. There are two such bars in the apparatus, the length of each is six metres.

Eight or more bases have been measured with these bars which offer considerable facility for rapid work; as much as a mile in one day having been completed with them.

As in Colby's apparatus however, the compensation cannot be absolutely relied on; the length of the bar depends on whether the temperature is rising or falling, and a length is assigned from actual comparisons in each of these conditions.

One of the last bases, that of Atalanta in Georgia, was measured three times (*U. S. C. Survey Report*, 1873), twice in winter and once in summer, the range of temperatures at which bars were laid extending from 18° Fahr. to 107° Fahr. By this means an extreme test of the performance of the bars was afforded. The line was subdivided into six segments of about a mile each. The discrepancies in the three measures

when compared with their respective means appear in the following table, expressed in millimetres :—

SEGMENTS.	FIRST MEASURE.	SECOND MEASURE.	THIRD MEASURE.
	mm.	mm.	mm.
I.	- 5.09	+ 1.76	+ 3.32
II.	+ 0.90	- 2.88	+ 1.97
III.	+ 4.37	- 0.23	- 4.14
IV.	- 2.29	+ 3.38	- 1.08
V.	- 2.68	+ 1.50	+ 1.18
VI.	- 3.31	- 3.85	+ 7.16
Sum	- 8.10	- 0.32	+ 8.41

These discrepancies are notably smaller than the carefully calculated probable errors of the three entire measures which are  $\pm 26^{\text{mm}}$ ,  $\pm 26^{\text{mm}}$ , and  $\pm 21^{\text{mm}}$  respectively; this is certainly an unusual phenomenon. By far the greater part of these probable errors is due to the comparisons of the bars with the standard. But the three measures were not absolutely independent. The final length of the base is  $9338.4763 \pm .0166$ , the probable error may be otherwise expressed as  $\pm 1.76 \mu$ . The probable errors of the seven previously measured bases varied from  $\pm 1.8 \mu$  to  $2.4 \mu$ .

A system of measurement wholly different to any of those just described is that of M. Porro, adopted by the *Dépôt de la guerre* for the measuring of bases in Algiers. In this system there is but one measuring bar which is made to measure the successive equal intervals between microscopes arranged—their axes vertical—in the line of the base. The number of microscopes is four, and the length of the bar is three metres, which is therefore the interval between two adjacent microscopes. Supposing the microscopes marked *A*, *B*, *C*, *D* in the direction of measuring, the bar is first placed under *A* and *B*, then after the microscopes are read it is transferred to *B* and *C*, and *A* is placed with its supporting trestle three metres in advance of *D*; and so on in succession.

Each microscope is supported on a very strong and massive trestle. The microscope and its immediate support may be

thus described:—a vertical cylindrical column springing from a tripod base with levelling screws, has two horizontal and parallel arms projecting perpendicularly to the base line; these hold the microscopes above and below in collars. In these collars the microscope rotates, and by means of an attached level can be made vertical; it can also be elevated or depressed small quantities for focal adjustment. The object-glass is of a peculiar construction; in order that one may read not only the bars at a few inches distance, but also when required a point of reference on the ground, there is a large object-glass of about a metre external focal length, and in the centre of this is fixed an object-glass of short focal length. A stop in front of the object-glass has in its centre an aperture corresponding to the diameter of the short focus object-glass. This stop can be removed at pleasure; when removed, points on the ground are visible, and when on, the divisions on the measuring bar can be read.

On the side of the vertical column, opposite to the microscope, is attached a bracket, which being somewhat massive serves as a counterpoise to the microscope, at the same time it is made to support the pivots of the horizontal transverse axis of a small aligning telescope. This bracket has a movement in azimuth round the column, and the centre of the telescope when directed in the line of the base is 0.144 of a metre distant from the axis of the microscope. The telescope can be removed and replaced by a graduated scale a decimetre in length. The telescope serves to read the graduated decimetre scale on the next following microscope in connection with a mark in the line of the base—or rather 0<sup>m</sup>.144 behind it—at a distance of some 300 metres. The reading of the scale corresponding to this mark determines the horizontal deviation from the line of the base. Thus account is kept of the direction of each position of the bar, the inclination being determined by a level.

In order that the aligning telescope may be able to show a point three metres off, as well as another at 300<sup>m</sup> or thereabouts, there is set within the tube of the telescope, behind the object-glass and concentric with it, a small lens, the actual position of which in the tube can be varied longi-

tudinally by means of a rack and pinion. This lens in combination with the object-glass can be adjusted so as to make the scale three metres off distinctly visible, while the remainder of the object-glass forms an image of the distant point of alignment.

The measuring bar is composed of two cylindrical rods laid side by side, of steel and copper, firmly united at their common centre and free to expand outwards. They are protected in a stout deal box strengthened by diaphragms; and there is an arrangement for measuring any flexure of the rods. Their ends project from the box, and each rod has a small scale of graduations at its extremity.

When the bar is adjusted under a pair of microscopes the scales on both rods are read, the readings being made simultaneously by two observers, one at each end; if there be any doubt as to the collimation of the microscopes they are rotated in azimuth  $180^\circ$  and read again.

The reference to the ground either at the extremities of the line, or at the end of a day's work, is effected as follows. A small scale divided to millimetres has a pin affixed perpendicularly to its under surface; this pin fits exactly into a hole in a copper disk firmly connected with the ground, or into a corresponding pinhole indicating the end of the base. The hole being approximately in the axis of the microscope—adjusted to perfect verticality—the pin of the scale is inserted into the hole and the length of the scale directed in the line of measurement.

In order to determine the distance of the optical axis of the microscope from the centre of the hole, the scale is read by the microscope, it is then reversed end for end and read again. Then in order to eliminate any collimation error in the object-glass, the microscope is turned through  $180^\circ$  of azimuth and the readings taken again.

The modification thus described of the original apparatus of M. Porro is due to Colonel Hossard. The description will be found in vol. ix of the *Memorial du dépôt général de la guerre*, Paris, 1871. The three bases measured with it in Algiers have probable errors estimated at  $\pm 1.0 \mu$  in each case.

The apparatus of Porro, still further modified and improved

by General Ibañez, was used by him for the measurement of the base lines in Spain. The measuring bar is four metres, or rather two toises in length. See the work entitled, *Base centrale de la triangulation géodésique d'Espagne par D. C. Ibanez Colonel du génie, &c.*, Madrid, 1863 (p. 564), which contains an elaborate account of the base of Madridejos. Also *Expériences faites avec l'appareil à mesurer les bases*, Paris, 1860 (p. 380), containing the description of the apparatus.

The base at Madridejos was divided into five segments; the central segment, 1.7 miles in length, was measured twice. It was subdivided into 12 sections of 234 metres length (one of the sections was a little short of this), each section was a day's work on each occasion of measurement. The differences of the two measurements of each section, expressed in millimetres, are these:

+ 0.23	+ 0.00	- 0.32	- 0.28
- 0.20	- 0.02	+ 0.39	+ 0.36
+ 0.49	- 0.23	- 0.09	- 0.14

the sum of the squares of which is .8765. Hence the mean error of the mean of the two measurements of this segment of the base is  $\frac{1}{2}\sqrt{.8765} = \pm 0.47$ , and its probable error  $\pm .32$  millimetres, showing a wonderful precision of measurement.

The two components were of copper and platinum, and the length was determined by 120 comparisons with Borda's rod No. 1.

The determination of the thermometric coefficient of the compound rod may be thus explained. Let there be two fixed microscopes, at the distance of two toises apart, adjusted to verticality and the readings of their collimation centres known. Let  $P$  be the length of the platinum bar at the time of observation,  $B$  that of the brass,  $t$  their common temperature at that moment: suppose that these bars are absolutely equal at the temperature  $\tau$ , having then the common length  $R$ . Then at the time of observation their lengths are

$$P = R + (t - \tau)e, \quad B = R + (t - \tau)e';$$

where  $e$  and  $e'$  are the respective expansions for one degree of temperature.



The micrometer heads being supposed both turned to the right, let  $a, b$  be the readings of the left and right microscopes for the bar  $P$ ,  $a', b'$  being the corresponding readings of  $B$ ; then if  $\alpha, \beta$  be the readings of the collimation centres, and  $h, k$  the values of one division of the micrometer in the two microscopes, the distance  $Z$  of the collimation centres is

$$\begin{aligned} Z &= R + (t-\tau)e - h(a-\alpha) + k(b-\beta), \\ Z &= R + (t-\tau)e' - h(a'-\alpha) + k(b'-\beta). \end{aligned}$$

Eliminate  $t-\tau$ , and we get

$$Z = R - h(a-\alpha) + k(b-\beta) + \{h(a'-\alpha) - k(b'-\beta)\} \frac{e}{e'-e}.$$

Let the small quantity  $Z-R = z$ , and put  $e = y(e'-e)$ ; then the observations of the two bars give an equation of the form

$$z + ay + c = 0.$$

Suppose now that by artificial means the bar is made to undergo changes of temperature while the microscopes remain fixed; then by observing the bar at different temperatures we have a series of equations of the same form as the above, in which the measured quantities  $a$  and  $c$  vary from one equation to another. But the microscopes cannot be supposed to remain absolutely fixed, except for comparatively short periods of time; suppose then that in the first  $i$  observations  $z$  has a value  $z_1$ , in the next group of  $i$  equations the value  $z_2$ , and so on; corresponding subscripts being also affixed to the observed quantities, the elimination of the  $z$ 's leads to the equation

$$y + \frac{(a_1)(c_1) + (a_2)(c_2) + (a_3)(c_3) \dots - i(ac)}{(a_1)^2 + (a_2)^2 + (a_3)^2 \dots - i(a^2)} = 0.$$

The sum of the squares of the coefficients of the measured quantities  $c$  in this expression for  $y$  is the reciprocal of

$$(a^2) - \frac{1}{i} \{(a_1)^2 + (a_2)^2 + (a_3)^2 + \dots\},$$

thus  $y$  and its probable errors are known; and in the measurement of the base the distance of the centres of two microscopes is at once expressible in the form  $Z = R + a + \beta y$ . In the Spanish apparatus the probable error of the value of  $R$  as resulting from comparisons with Borda's rod No. 1 was  $\pm 0^{\text{mm}}.001$ .

The annexed figure shows the base line of Madridejos with the verificatory triangulation, constituted by the five segments and four external points. The observed angles at the ten stations

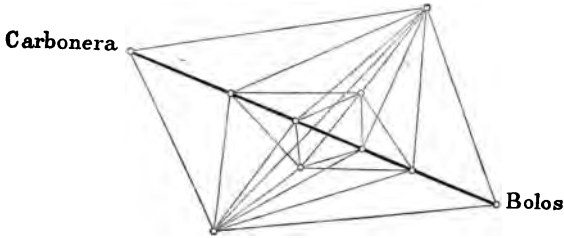

Fig. 34.

give the means of calculating the lengths of any four segments from an assumed length of the fifth. Taking the measured length of the central segment as the basis of the calculation, the contrast of the measured and computed lengths of the outer segments stands thus :

SEGMENT.	MEASURED.	CALCULATED.	DIFFERENCES.
	m.	m.	m.
I.	3077.459	3077.462	- 0.003
II.	2216.397	2216.399	- 0.002
III.	2766.604	"	"
IV.	2723.425	2723.422	+ 0.003
V.	3879.000	3879.002	- 0.002
Sum	14662.885	14662.889	+ 0.004

## CHAPTER VIII.

### INSTRUMENTS AND OBSERVING.

#### 1.

WITHOUT a large number of drawings it would be impossible to give an idea of the variety of forms adopted in the construction of theodolites for geodetic—including in that term astronomical—purposes. They may be divided into three classes: (1) Altazimuths, which are available for both terrestrial and astronomical work; (2) those which are intended for terrestrial angles, and also for determinations of absolute azimuth, but not for latitudes; (3) those intended only for terrestrial angles. The larger instruments are read by micrometer microscopes, the smaller by verniers. In some theodolites the microscopes of the horizontal circle move round with the telescope while the circle is fixed; in others the circle moves with the telescope and the microscopes are fixed.

The two large theodolites of Ramsden, which have been already described, belong to the second of the classes specified, the microscopes for reading the horizontal circle being fixed. For the great Trigonometrical Survey of India, Colonel Everest had two theodolites with horizontal circles of three feet, and vertical circles of 18 inches—belonging to the class of altazimuths—the former circles being read by five microscopes, the latter by two. Besides these there were his two ‘astronomical circles,’ altazimuths also in form, consisting of the following portions;—a double vertical circle of 36 inches diameter, formed of two parallel circles united, with a telescope between them; the circles are divided into 5' intervals, and the telescope is 54 inches in focal length and 3.46 inches aperture. On one side the vertical circles are read by two

fixed microscopes, on the other side by two moveable microscopes. These instruments were used for the determination of latitudes by measurement of the zenith distances of stars on the meridian, being used simultaneously at pairs of stations.

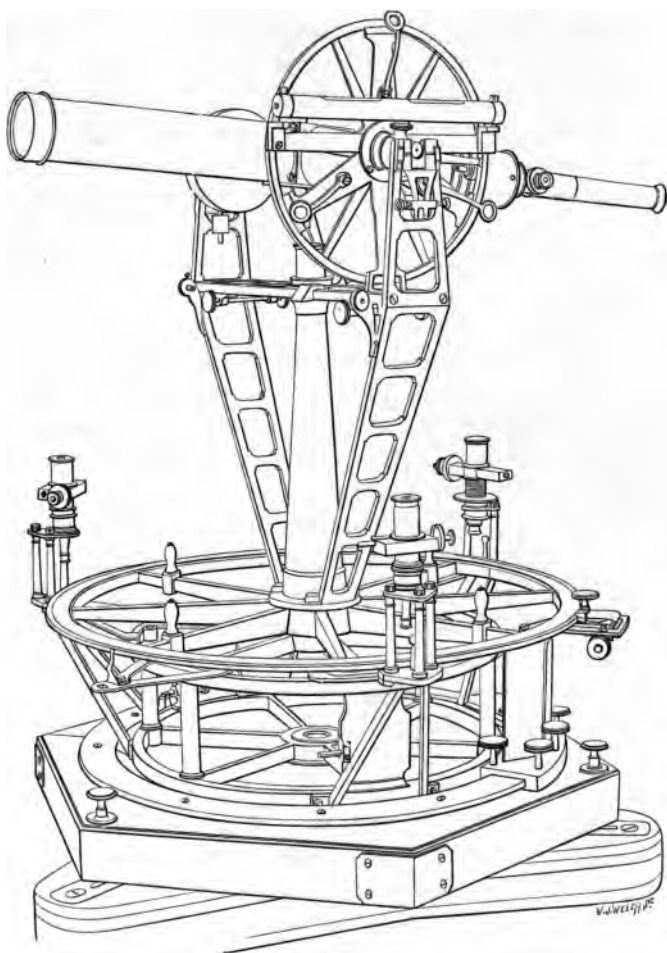

Fig. 35.

The instruments employed on the Principal Triangulation of Great Britain and Ireland were, besides the two large theodolites of Ramsden, a smaller one of 18 inches diameter,—represented in the above figure—also by Ramsden; and an

altazimuth by Troughton and Simms. This instrument has a repeating stand, and a horizontal circle of 2 feet diameter. The circle is connected by six conical radii to the axis of the instrument, which is conical and of steel. A cylindrical drum, 8 inches in diameter, having six vertical microscopes attached to it, and an interior hollow axis, is placed on the steel axis just mentioned, and revolves round it. From a metal plate on the surface of the drum rise two columns supporting the Y's which take the pivots of the telescope axis; they are sufficiently high to allow the telescope to rotate in a vertical plane through  $180^\circ$ . The telescope has a focal length of 27 inches, and aperture of 2.12; it is fixed between two parallel vertical circles of 15 inches diameter concentric with the axis of rotation of the telescope. The horizontal and both vertical circles are divided into 5' spaces, the latter are read by microscopes passing through the pillars. The instrument is supported by three levelling screws on the repeating stand; this has never been used for the purpose of repetition<sup>1</sup> but serves for changing the position of the zero of the circle. The whole instrument, including the repeating stand, rests on three levelling foot screws. A vertical telescopic microscope passes down through the axis of the theodolite for centering it over the station mark. The instrument is represented in the next page, fig. 36.

In the United States Coast Survey the larger theodolites have diameters of 24 and 30 inches. The theodolites used on the European continent are generally smaller. Struve, for his own personal use in his great arc measurements, used a 'universal instrument'—equivalent to an altazimuth—made by Reichenbach. The horizontal circle had a diameter of 13 inches, the vertical circle 11 inches; they were read each by four verniers to 4", or by estimation to seconds. In the middle of the telescope a prism bent the rays of light at right angles so as to pass out at one of the pivots where was situated the eyepiece. The magnifying power used was 60; the focal length 18 inches, and the aperture 1.75 inch. There was a lower telescope attached to the horizontal circle called a telescope of verification, destined to detect any shifting of the

<sup>1</sup> Exception made for a few experimental observations in 1828-29.

circle while the upper telescope was being used. This instrument was used not only for terrestrial angles, but for azimuth,

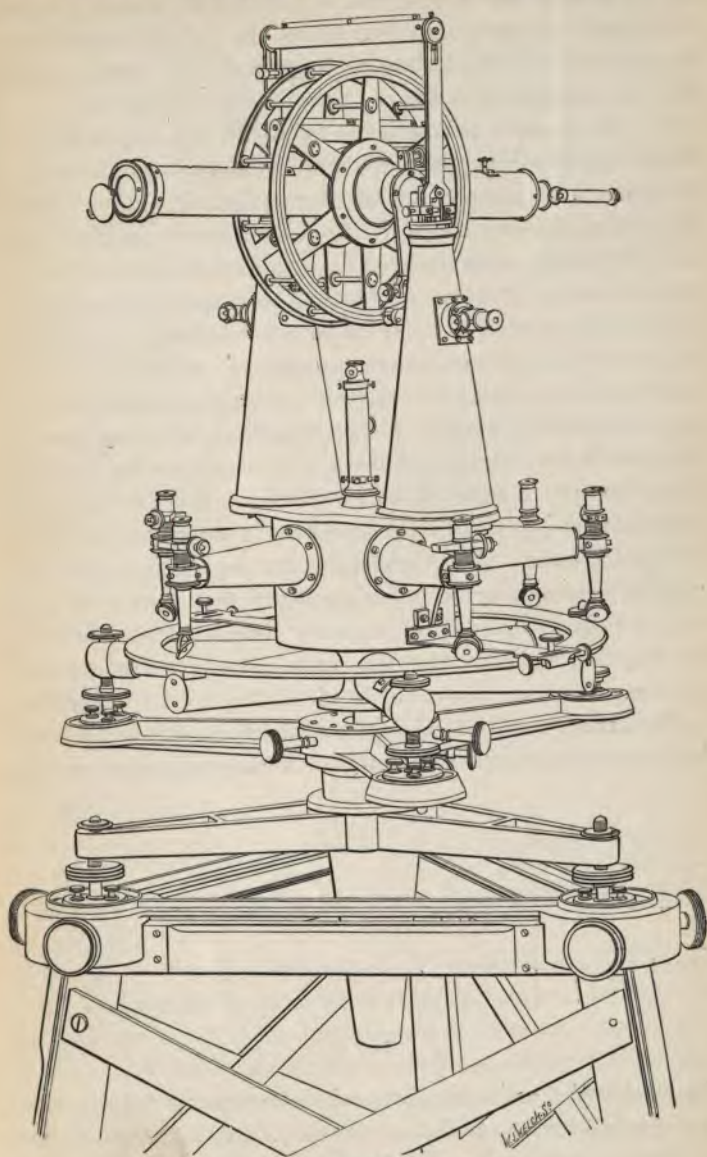

Fig. 36.

time and latitude. 'Notwithstanding its complicated construction,' says Struve, 'it is mathematically admirable as a whole, and in its details, and it requires a rational observer who shall have studied it scrupulously. In the hands of such an one it fulfils its functions to perfection.' And certainly his own work with it was of marvellous precision.

In the present triangulation of Spain the theodolites (by Ertel and Repsold) used for terrestrial work have diameters of 12.5 and 14.5 inches: for astronomical work, a theodolite by Repsold with a horizontal circle of 12.5 inches and a vertical of 10.25 inches, each read to two seconds by means of a pair of micrometer microscopes; and a transit telescope, *anteojo de pasos*, with a horizontal circle of 21.8 inches, the focal length of the telescope 31.5 inches and an aperture of 2.68 inches. The telescope, as in the other instruments also, is bent at right angles, and the length of the transverse axis between the supports is 19.5 inches; there is also an apparatus by which the telescope is reversed in its Y's in a few seconds. The horizontal and vertical circles are merely for setting purposes.

The footscrews of a theodolite rest generally in three converging grooves; or in some cases one foot rests in a small conical hole, the second in a groove directed to the first, and the third on a plane; thus the first has no freedom to move, the second has one degree of freedom, the third is quite free.

The arrangements of the spider lines forming the 'reticule' in the common focus of object-glass and eye-piece are various:

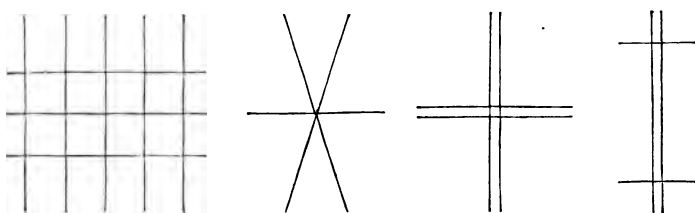

Fig. 37.

in altazimuths, as in astronomical instruments generally, there are five or seven equidistant vertical threads crossed by one or three horizontal. For terrestrial observations there is either an acute cross intersected by a horizontal thread, or a

pair of close vertical threads intersected by a pair of horizontal, enclosing between them a small square of 40" or 50" side. The object observed is to be brought into the centre of the square or bisected by the cross. Micrometer microscopes have either a cross for bisecting the graduation lines, or a pair of close parallel threads between which the graduation lines are to be brought.

The line joining the optical centre of the object-glass with the centre thread, or centre of the small square, or intersection of cross, is the line of collimation; it is intended to be at right angles to the transverse axis of the telescope, when it is so it traces out a plane as the telescope revolves, when there is collimation error it traces out a conical surface. The line of the Y's supporting the telescope axis should be at right angles to the vertical axis; it is liable to a small error. The pivots of the telescope axis are generally unequal, and their difference requires investigation. All large theodolites have two delicate levels, one connected with the vertical circle, the other for the transverse telescope axis; the value of one division of these levels requires careful determination, and at different temperatures, as in some cases they vary with the temperature. Micrometer microscopes read generally single seconds, but it is necessary to verify this from time to time and correct their readings if necessary.

The errors of graduation of a circle are of two classes—periodical and accidental. The former are expressed by the formula

$$E_{\theta} = a_1 \sin(\theta + b_1) + a_2 \sin(2\theta + b_2) + a_3 \sin(3\theta + b_3) + \dots,$$

where  $E_{\theta}$  is the graduation error corresponding to circle reading  $\theta$ .

The error of eccentricity may be considered as a graduation error, represented by the first term of this series. If the circle be read by  $i$  equidistant microscopes, it is easy to prove that the error of the mean of the  $i$  readings contains only those terms which involve  $i\theta$  and multiples of  $i\theta$ . For instance, with three microscopes, the error of the mean reading is

$$\frac{1}{3} \{E_{\theta} + E_{\theta+120} + E_{\theta+240}\} = a_3 \sin(3\theta + b_3),$$



if we suppose the series to end with  $a_6$ . In this case this portion of the error is the same under each of the microscopes; hence it cannot be eliminated by readings of the circle. But if two collimators be set up, so as to present a right angle for measurement by the circle,  $a_3$  and  $b_3$  can be determined.

The centres of trigonometrical stations are indicated generally by a well defined mark on the upper surface of a block of stone buried at a sufficient depth below the surface. In the vicinity of a base line these marks are microscopic. The precision of the results of a triangulation is dependent on the precision with which the observing theodolites are centred over the station marks. Whatever be the form of the signal erected over a trigonometrical station, it is essential that it be symmetrical with respect to the vertical line through the centre mark, so that the observation of the signal shall be equivalent to an observation of a plumb-line suspended over the mark. For very distant stations a heliostat is used, which centred over the station observed, reflects the rays of the sun to the observing theodolite. On the Ordnance Survey the heliostat is a circular looking-glass provided with a vertical and a horizontal axis of rotation, kept constantly directed by an attendant.

It is essential that the theodolite be supported on a very solid foundation. The mode of effecting this must depend on the nature of the ground: generally it is sufficient to drive strong stakes as far as possible into the earth, then to cut them off level with the surface, and so form an immediate support for the stand of the instrument. In all cases the theodolite is sheltered by an observatory, the floor of which has no contact with the instrument stand.

In order to command distant points it is sometimes necessary to raise the instrument by scaffolding 40, 60, or as much as 80 feet above the ground; in such cases an inner scaffold carries the instrument, a second or outer scaffold supporting the observatory, as shown on the next page<sup>1</sup>.

The method of observing is this: let  $A, B, C \dots H, K$  be the

<sup>1</sup> Fig. 38 is the drawing of a scaffold, seventy feet high, built by Sergeant Beaton, R.E.

points to be observed, taken in order of azimuth; then, the instrument being in adjustment and level, *A* is bisected and the microscopes read, then *B* is similarly observed, then in succession the other stations *C...H, K*; after *K* the movement of the telescope is continued in the same direction round to *A*, which is observed a second time. This constitutes what is termed on the Trigonometrical Survey of Great Britain 'an arc' (French, *mise*; German, *satz*). A more ordinary procedure is to observe the points as before in the order *A, B, C...H, K*, then reversing the direction of motion of the telescope, to reobserve them in the inverted order *K, H...C, B, A*.

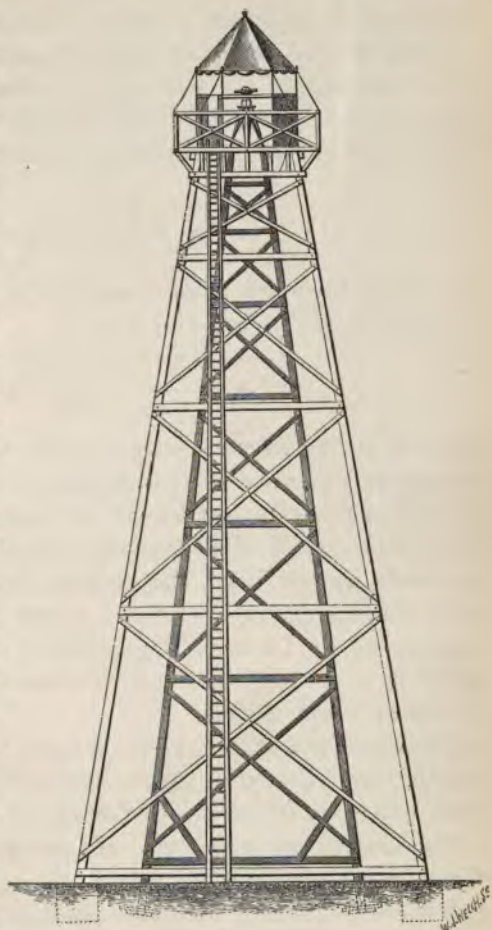

Fig. 38.

Thus each point in the arc is observed twice.

In order to eliminate errors of graduation it is the practice to repeat arcs in different positions of the horizontal circle; some observers shift the zero of the circle after each arc, others take a certain number of arcs in each position of the zero. Supposing the circle to remain really fixed during the taking

of an arc (which is executed in as short a period of time as possible), the probable error of an observed angle will depend on the errors of bisection of the objects observed, on the errors of reading the circle, and on errors of graduation. If  $a$  be the probable error of a bisection,  $\beta$  the probable error of the mean of the readings of the microscopes,  $\gamma$  the error of the angle due to faults in the division lines actually used, then the error of the angle as measured by  $n$  arcs in the same position of the circle is

$$\gamma \pm \sqrt{\frac{2}{n}(a^2 + \beta^2)}.$$

But taking the angle from  $n$  measures in each of  $m$  positions of the circle, the probable error is

$$\pm \sqrt{\frac{\gamma^2}{m} + \frac{2a^2 + 2\beta^2}{mn}},$$

where  $\gamma$ , having reference only to accidental errors of division, is a constant peculiar to each instrument.

With a first-rate instrument in favourable circumstances the probable error of a bisection, including that of reading the circle is,  $\pm 0''.20$ . The probable error of an observed angle depends on the instrument, on the observer, and on the numbers  $n$ ,  $m$ . In the best portions of the Indian triangulation it is  $\pm 0''.28$ ; in Struve's observations in the Baltic Provinces it was  $\pm 0''.38$ .

Ramsden's Zenith Sector, which had a telescope of 8 feet in length, was destroyed in the fire at the Tower of London, and was replaced by Airy's Zenith Sector.

This instrument, represented in the next page, fig. 39, is in three parts; the outer framework, the revolving frame, and the telescope frame. The framework is cast in four pieces; the lower part, an inverted rectangular tray with levelling footscrews; two uprights with broad bearing pieces screwed to the inverted tray; and a cross bar uniting the tops of these uprights. Through the centre of this bar passes downwards a screw with a conical point, which, together with the vertex of a cone rising from the centre of the inverted rectangular tray, determine the axis of revolution and form the bearings of the revolving frame.

The revolving frame is of gun metal cast in one piece. It is also in the form of a tray strongly ribbed at the back,

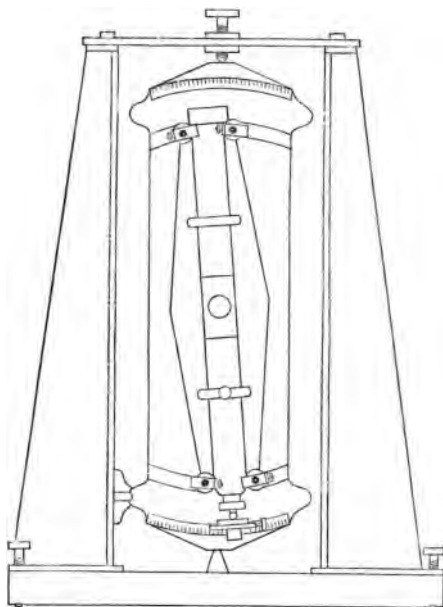

Fig. 39.

having four lappets or ears acting as stops in the revolution. In the centre of the front of this frame is a raised ring of about nine inches diameter, forming the bearing plate of the telescope frame. Concentric with this ring at each end of the frame are the divided limbs, which have a radius of 20.5 inches, and are divided on silver to every five minutes. There is also at each end a raised clamping-limb roughly divided, to which the clamp for securing the telescope at the required zenith distance is attached. On the reverse side of the revolving frame are mounted three levels.

The telescope frame revolves in a vertical plane by a horizontal axis passing through the revolving frame. Cast in one piece with the telescope frame are, the ring for holding the object-glass cell of the telescope, the four micrometer micro-

scopes, which are afterwards bored through the metal, and the eye-piece. The micrometers are of the usual construction, the threads intersect in an acute angle, and have a range of about 10 minutes on the divided limb.

In the eye-piece of the telescope are five meridional threads, carried by a fixed plate, and a single thread at right angles to them, moved by a micrometer screw. The tube of the telescope is merely a protection from dust, and carries no essential part of the instrument except a simple apparatus for regulating the amount of light illuminating the threads, which by the turning of a screw, increases or diminishes the orifice through which the light enters. The focal length of the telescope is 46 inches, the diameter of the object-glass 3.75 inches, and the magnifying power usually employed about 70.

The deviation of the plane of the instrument from the meridian, which is generally very small, being carefully ascertained by observations of the transits of north and south stars, and the axis being as nearly as possible vertical, the observer sets the telescope to the approximate zenith distance of the star to be observed, clamps it, and before the star enters the field reads the four micrometer microscopes and the levels. The star on its appearance is bisected by the eye-piece micrometer on one of the threads, the name of the thread being recorded with the reading of the micrometer. The telescope is then unclamped and the revolving frame reversed by turning it through  $180^\circ$  on its vertical axis, so that the face which before was east is now west. The telescope is quickly re-set to the approximate zenith distance and clamped, and the star again bisected by the telescope micrometer on one of the threads, generally the same one on which it was previously observed. The five micrometers are then read and the levels on the reverse side. This completes the double observation.

The amount of the azimuthal deviation is ascertained by comparing the differences of the observed times of transit of north and south stars with their differences of right ascension. If  $\Delta$  be the excess of the difference of right ascension of two stars over the observed difference of times of their transits,  $\delta$   $\delta'$  their declinations, and  $\phi$  the latitude of the instrument,

then expressing  $\Delta$  in seconds of time,  $a$ , the azimuthal deviation, is in seconds of space,

$$a = \frac{15 \Delta \cos \delta \cos \delta'}{\cos \phi \sin (\delta - \delta')}.$$

The correction to the zenith distance  $z$ , on account of this deviation, is

$$- \frac{\sin^2 a \sin z \cos \phi}{\cos \delta \sin 2''}.$$

The correction for the distance  $i$  from the meridian, of the thread on which the star is observed is

$$\pm \frac{i^2}{2} \tan \delta \sin 1'',$$

the upper sign applying to south stars, the lower sign to north stars. The latitudes of 26 stations of the principal triangulation of Great Britain and Ireland have been observed with this instrument.

The latitudes of a still larger number have been determined with the Zenith Telescope. This instrument, which is of very simple construction and very portable, is represented on the next page. The telescope, 30 inches in length, is fixed at one end of a short horizontal axis, and is counterpoised at the other; thus the optical axis describes a vertical plane, that of the meridian when in use. The lower part consists of a tripod with levelling screws connected with a steel axis about 15 inches high, and an azimuthal setting circle. On the steel axis fits a hollow axis which carries at its upper extremity the horizontal axis of the telescope. The latter has a setting circle and a very sensitive level. The reticule consists of the ordinary five transit threads and a transverse thread moved by a micrometer screw of long range, by which an angle of  $30'$  may be measured in zenith distance. In the plate forming the horizontal circle are four circular holes, by means of one of these, the telescope being pointed to the nadir, the collimation is corrected by means of a Bohnenberger eye-piece and a basin of mercury.

For observing, the first thing is to ascertain the reading of the meridian on the setting circle; this is done by a few transits observed. The observer is provided with a list of

stars in pairs; each pair is subject to the condition that the interval of their right ascensions is between  $2^m$  and  $10^m$  and the difference of their zenith distances not greater than  $15'$ ; one star passes north of the zenith, the other south. Now let the telescope be set to the mean of the zenith distances and directed to the south, say, supposing the first star to pass south of the zenith. The star as it passes is bisected by the micrometer thread on the centre thread. The instrument is then rotated through  $180^\circ$  of azimuth, not disturbing the telescope; the second star will then at the proper time pass through the field, and is in like manner bisected on the centre thread. Knowing the value of a division of the micrometer we have at once, by the difference of the micrometer readings, the difference of zenith distance of the

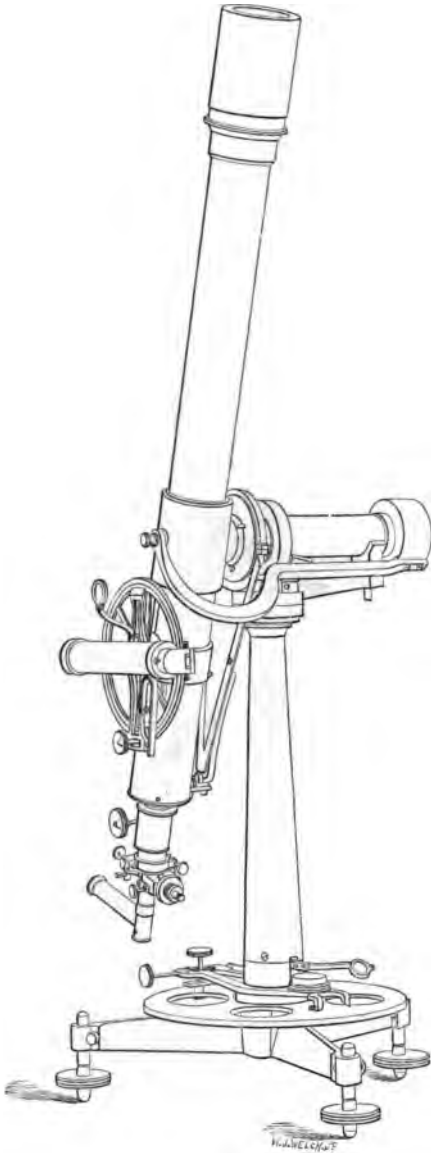

Fig 40.

stars which leads immediately to the knowledge of the latitude. Each star observation is accompanied by readings of the level. In this method, refraction is virtually eliminated, since it is only the difference of the refractions at the two nearly equal zenith distances which has to be applied. The value of the micrometer-screw is determined by observing on the micrometer thread, transits of Polaris, while its movement is vertical or nearly so, that is, from  $20^m$  before to  $20^m$  after its time of greatest azimuth. Thus, in connection with observations of the level, an accurate knowledge of the screw over its whole range is obtained.

This instrument is the invention of Captain Talcott, U. S. Engineers, and is exclusively used for latitudes in the U. S. Coast Survey. Its weak point is that in the selection of the pairs of stars, it may be necessary to use some stars whose places are but indifferently known. In this latitude, however, no great difficulty is found in obtaining pairs of stars whose places are given either in the Greenwich or Oxford Catalogues. As made by Wurdemann it is an instrument of extreme precision and most pleasant to observe with. We have had a case for instance at Findlay Seat in Elginshire, where thirty-one pairs observed successively in one night presented a range not exceeding  $2''.00$ .

The drawing in Fig. 41 represents a very excellent portable transit instrument used on the Ordnance Survey in connection with the Zenith Telescope. The uprights are of mahogany, built of pieces screwed together; it has a reversing apparatus by which the telescope can be reversed in  $15^\circ$ . The focal length is 21 inches and its aperture 1.67 inches.

## 2.

A telescope mounted on a transverse axis, as that of an altazimuth or transit instrument, as it rotates round that axis, experiences alterations of force which, since the material of which both telescope and axis are composed is not rigid but rather flexible, tend to change its form. Suppose, in the first place, that the instrument is perfectly rigid, perfectly



collimated, and perfectly level, its centre thread tracing out, say, the meridian plane; then if flexure be introduced, at every

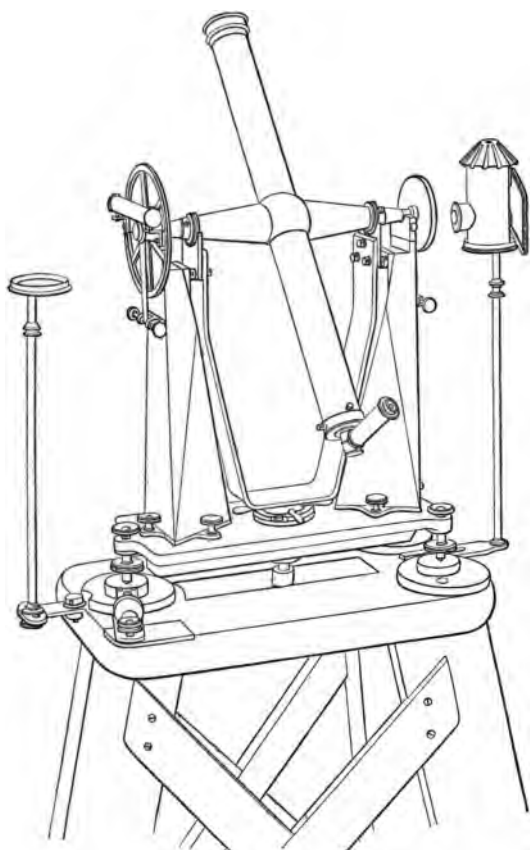

Fig. 41.

zenith distance there will be a deflection of the telescope out of the meridian. It has been shown by Sir George Airy (*Monthly Notices of the R. A. S.*, January 1865) from mechanical considerations, that  $z$  being the zenith distance of the point to which the telescope is directed, this deflection is of the form  $A \sin z + B \cos z$ , from which it follows that the path traced by the centre thread is still a great circle. The pole of this great circle, instead of being at the east point of the

horizon, will have azimuth  $90^\circ + a$ , and zenith distance  $90^\circ + b$ , where  $a$  and  $b$  are minute angles. Now when the transit is reversed in its Y's, the pole of the great circle described in this case is in azimuth  $270^\circ + a$ , and its zenith distance is, as before,  $90^\circ + b$ . That is, the instrument, though it collimates on a horizontal point, will not be in collimation at the zenith; there will appear an error of the nature of a level error, changing sign with change of pivots, combining in fact with the error of inequality of pivots.

The diagonal form of transit instrument, in which the rays of light instead of passing straight from the object-glass to the eye-piece are bent at right angles by a prism in the central cube and so pass out at one of the pivots, is not so well known in this country as in Germany and Russia. The advantages of this construction are, that the observer without altering his position can observe stars of any declination, that the uprights are short, and that the level can remain on the pivots as the telescope sweeps the meridian, nor need it be taken off on reversing the telescope. There is a special apparatus for reversal; from very numerous observations made with one of these transits the disturbance due to reversal of the telescope was found to be  $\pm 0''.19$  in azimuth, and  $\pm 0''.13$  in level. But the effect of flexure in this instrument is very obvious. The weight of the telescope, the central cube, and the counterpoise, cause the prism to be displaced vertically downwards by a nearly constant quantity; so that the image of a star in the field is always vertically below its proper place at a distance, say  $f$ . Thus every micrometer reading of an object in the field requires a correction  $-f \cos z$ ; the magnitude of  $f$  can be obtained by comparing the reading of the collimation centre, as determined on a horizontal mark, with the same as determined on a collimator in the zenith or at any zenith distance not near  $90^\circ$ . To determine  $f$  in the case of a Russian Transit of this description employed for a time on the Ordnance Survey, a collimator was arranged so as to be capable of being set at any zenith distance whatever; the result from 172 observations was  $f = 3''.16 \pm 0''.04$ . In the reduction of the observations, this quantity is added to difference of pivots, which in the same instrument was

$0''.65 \pm 0''.02$  (see a Paper on this subject in the *Mem. R. A. Soc.*, Vol. xxxvii).

## 3.

Let  $\phi$  be the latitude of the place of observation,  $z$ ,  $a$  being the zenith distance and the azimuth of an observed star  $S$  whose declination is  $\delta$ , its hour angle being  $h$ . We shall suppose that  $h$  is zero at the upper culmination, increasing from 0 to  $360^\circ$ ; and that the azimuth is zero when the star is north, and increases from 0 to  $360^\circ$  in the direction from north to east. Then in the spherical triangle  $ZPS$ ,  $Z$  being the zenith and  $P$  the pole,

$$\begin{aligned} ZP &= 90^\circ - \phi, & PS &= 90^\circ - \delta, \\ PZS &= a, & ZPS &= 360^\circ - h; \end{aligned}$$

and the following equations express  $z$  and  $a$  in terms of  $\phi$ ,  $\delta$ ,  $h$ ,

$$\begin{aligned} \cos z &= \sin \delta \sin \phi + \cos \delta \cos \phi \cos h, & (1) \\ \cos a \sin z &= \sin \delta \cos \phi - \cos \delta \sin \phi \cos h, \\ \sin a \sin z &= \cos \delta \sin h. \end{aligned}$$

If  $T$  be the reading of the clock,  $\tau$  its correction,  $A$  the right ascension of the star, then the hour angle is given by

$$h = 15 (T + \tau - A).$$

The equations (14) of spherical trigonometry express the influence upon  $z$  and  $a$  of variations in  $\delta$ ,  $\phi$ , and  $h$ ; thus,  $S$  being the parallactic angle,

$$\begin{aligned} \sin z da &= -\sin S d\delta + \cos \delta \cos S dh + \cos z \sin a d\phi, \\ dz &= -\cos S d\delta - \cos \delta \sin S dh - \cos a d\phi. \end{aligned}$$

When the place of a star is required with great precision it is necessary to take into account the effect of diurnal aberration, whereby the star is displaced towards the east point,  $e$ , of the horizon by the amount  $0''.311 \cos \phi \sin S e$ , increasing thus the azimuth and zenith distance by quantities  $\delta a$  and  $\delta z$ , given by the equations,

$$\begin{aligned} \sin z \delta a &= 0''.311 \cos \phi \cos a, \\ \delta z &= 0''.311 \cos \phi \sin a \cos z, \end{aligned}$$

which are easily verified geometrically.

Let the adjoining figure represent the celestial sphere stereographically projected on the plane of the horizon,  $ns$  being the meridian,  $we$  the prime vertical. Let  $p$  be the point in which one end of the axis of rotation of the telescope, whether of theodolite or transit instrument, meets the sphere. It is necessary to discriminate between this point  $p$  and that which is directly opposite to it. As the telescope may be reversed in its Y's, we shall suppose that in the case of the

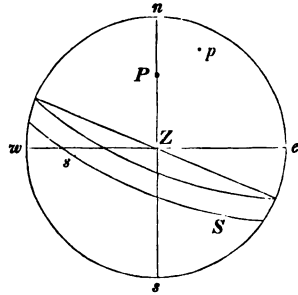

Fig. 42.

theodolite  $p$  refers to that Y which is to the left of the observer as he looks through the telescope; in the transit instrument  $p$  will correspond to that Y which is either near the north or near the east. The distance at which a point is observed from the collimation centre, that of one of the side threads, for instance, in the transit instrument, is to be considered positive when the image or the thread is on the same side of the telescope as is the divided or setting circle. If  $c$  be this distance, then, when the circle end of the telescope is on the Y corresponding to  $p$ , the angular distance of  $p$  from the point observed is  $90^\circ + c$ . Thus the thread defined by  $c$  will in the one position trace out a small circle  $Ss$  whose radius is  $90^\circ + c$ , and when the telescope is reversed it will describe a small circle whose radius is  $90^\circ - c$ . Let  $a$  be the azimuth  $nZp$  of  $p$ ,  $Zp$  its zenith distance  $= 90^\circ - b$ , so that  $b$  is the level error. Let  $a$  be the azimuth  $nZS$  of an observed object  $S$ , its zenith distance,  $ZS$  being  $= z$ . Then the triangle  $pZS$  in the case of the circle end of the axis being next  $p$  gives

$$-\sin c = \sin b \cos z + \cos b \sin z \cos (a - a); \tag{2}$$

the level error never exceeds a few seconds, so that  $\cos b = 1$ , and  $c$  is never so large that we may not substitute  $c$  for its sine, hence the above equation may be written

$$c + b \cos z + \sin z \cos (a - a) = 0. \tag{3}$$

from which

$$a = a + \frac{c + b \cos z}{\sin z} + 90^\circ.$$

Let another object,  $S'$ , having azimuth  $a'$  and zenith distance  $z'$ , be also observed, then  $b'$  being the corresponding level error, and  $a'$  the azimuth of  $p$ ,

$$a' = a' + \frac{c + b' \cos z'}{\sin z'} + 90^\circ;$$

$$\therefore a' - a = A + c \left( \frac{1}{\sin z'} - \frac{1}{\sin z} \right) + \frac{b'}{\tan z'} - \frac{b}{\tan z}. \quad (4)$$

Neglecting quantities of the order  $b^2$ ,  $a' - a$ , which we have here replaced by  $A$ , is the difference of the readings of the horizontal circle when the theodolite is pointed to  $S$  and  $S'$ . Suppose that  $S$  being a star,  $S'$  to the right of  $S$  is a terrestrial mark, then this equation gives the azimuth of the mark in terms of the known azimuth of the star, the angle measured by the theodolite, and the level and collimation errors. The collimation must be eliminated by reversing the telescope, and in computing  $b$ , the inequality of pivots must be taken into account.

If in the equation (3) we expand the cosine and substitute the values of  $\sin z \cos a$  and  $\sin z \sin a$  from (1), the result is

$$c + b \cos z + \cos a \cos \phi \sin \delta - \cos a \sin \phi \cos \delta \cos h - \sin a \cos \delta \sin h = 0, \quad (5)$$

which equation will apply to the transit instrument in any position. It gives us in fact  $h$ , the hour angle of the star whose declination is  $\delta$  when observed on the thread defined by  $c$ .

In observing transits it is usual to reduce the observed time of transit of a side thread to the time of transit over the collimation centre, or over the middle thread if that be truly collimated. When used in the meridian, the mean of the times of transit over the individual threads is taken, and this mean represents the time of transit over what may be called the mean thread.

But when the instrument is not in the meridian we cannot always so take the means of the times, as the time

intervals on the right and on the left of the centre thread are not equal. In order to determine the interval of time taken by a star to pass from the thread  $c$  to that thread for which  $c$  is zero, put  $b = 0$  in (5). And if again in this equation so modified we put  $c = 0$ , and write  $h'$  for  $h$ , the result is

$\cos a \cos \phi \sin \delta - \cos a \sin \phi \cos \delta \cos h' - \sin a \cos \delta \sin h' = 0$  ;  
 put  $h - h' = 2I$ ,  $h + h' = 2H$ , and the sum and difference of our equations give

$$\begin{aligned} 2 \cos I \cos \delta \{ \cos a \cos H \sin \phi + \sin a \sin H \} \\ = c + 2 \cos a \cos \phi \sin \delta, \\ 2 \sin I \cos \delta \{ -\cos a \sin H \sin \phi + \sin a \cos H \} = c. \end{aligned}$$

Take two subsidiary angles  $\psi$  and  $G$ , such that

$$\begin{aligned} \sin \psi \cos G &= \sin a, \\ \sin \psi \sin G &= \cos a \sin \phi, \\ \cos \psi &= \cos a \cos \phi, \end{aligned}$$

and substitute in the last equations. The result is

$$\begin{aligned} 2 \cos I \cos \delta \sin \psi \sin (G + H) &= c + 2 \cos \psi \sin \delta, \\ 2 \sin I \cos \delta \sin \psi \cos (G + H) &= c. \end{aligned}$$

Now eliminate  $G + H$  from these, and the result is a quadratic in  $\sin^2 I$ . If we further put

$$C \sin (\psi + \delta) = c = C' \sin (\psi - \delta),$$

the solution of the quadratic is<sup>1</sup>

$$\pm \sin I = \frac{(CC')^{\frac{1}{2}}}{(1 + C')^{\frac{1}{2}} + (1 - C)^{\frac{1}{2}}}. \quad (6)$$

When the instrument is reversed the signs of  $C$  and  $C'$  are changed. This is the formula used by Bessel in the reduction of his transits in the prime vertical. When the transit is exactly in the prime vertical  $a = 0$ , and  $\psi = \phi$ ,

$$C = \frac{c}{\sin (\phi + \delta)}, \quad C' = \frac{c}{\sin (\phi - \delta)}.$$

#### 4.

When the transit instrument is in the meridian  $a$  is near  $90^\circ$ . In equation (5) for  $a$  write  $90^\circ + a$ , and suppose  $a$  to be so small that  $\cos a$  may be put  $= 1$ ; then also  $h$  will be

<sup>1</sup> *Gradmessung in Ostpreussen*, page 312.

very nearly 0 or 180°, and we may put  $\cos h = \pm 1$ . Thus

$$a \sin(\phi - \delta) + b \cos(\phi - \delta) + c - h \cos \delta = 0,$$

for an upper transit, where the coefficient  $\cos z$  of  $b$  has been replaced by  $\cos(\phi - \delta)$ .

For brevity let  $a, b, c$  now stand for the azimuth, level, and collimation errors, divided each by 15 to reduce them to the unit of seconds of time, then the correction to the clock time is, since  $\frac{1}{15}h = T + \tau - A$ ,

$$\tau = A - T + a \sin(\phi - \delta) \sec \delta + b \cos(\phi - \delta) \sec \delta + c \sec \delta. \quad (7)$$

This formula is known as 'Mayer's'; it has been put by Hansen in the form

$$\tau = A - T + b \sec \phi + n(\tan \delta - \tan \phi) + c \sec \delta, \quad (8)$$

which is easily verified, the value of  $n$  being  $b \sin \phi - a \cos \phi$ .

The last of these is specially convenient for the reduction of transits of stars near the zenith. On reversing the instrument, which is done at least once or twice in each evening's work, the sign of  $c$  is changed, being positive for circle east and negative for circle west. The sign of  $b$  is positive when the east end of the axis is high. In these formulæ, for lower culmination (*sub polo*)  $180^\circ - \delta$  must be written for  $\delta$ , and  $12^h + A$  for  $A$ ; also  $A$  must be increased by  $0^s.02 \cos \phi \sec \delta$  for daily aberration when great precision is aimed at. The method of least squares is generally adopted for the determination of the azimuth, the error at a stated moment, and the rate of the clock; every transit giving one equation.

In commencing to observe with a portable transit at a new station, the first matter is to secure a very firm foundation, and to remove or reduce to a minimum the collimation error; then having placed the instrument as nearly in the meridian as can be done by any ready means of estimation, to level the transverse axis. If the clock error be known the observer has merely to take a quick moving star of large zenith distance approaching the meridian, and follow it up to the moment of transit with the middle thread of the telescope. Suppose, however, the clock error to be unknown: in this case let two stars differing considerably in declination be observed, let the first give an apparent clock correction  $\tau_1$ , and the

second an apparent clock correction  $\tau_2$ , then the formula

$$\tau = \tau_1 + (\tau_2 - \tau_1) \frac{\tan \delta_1 - \tan \phi}{\tan \delta_1 - \tan \delta_2} \quad (9)$$

will give very approximately the real correction of the clock, which will serve for placing the instrument nearly in the meridian. The formulæ (7) or (8) show that stars near the zenith are best suited for the determination of the time when there is uncertainty of azimuth. For determining the azimuth it is desirable to include in an evening's observations one or more transits of close circumpolar stars, even if observed only on one thread. In order to secure this the portable transit is sometimes used out of the meridian, namely, in the vertical plane passing through a circumpolar star.

The method of time determination by a transit instrument set in the vertical of Polaris is very generally adopted in continental Europe, having the advantage of securing the knowledge of the azimuthal position of the instrument without any uncertainty, the transit of each time star being immediately accompanied by an observation of Polaris. The instrument, instead of being placed in the meridian, is placed with its centre thread slightly in advance of the position of Polaris, and accurately levelled. For this method of observing, the instrument must have a micrometer carrying a vertical thread across the field; also it must have an arrangement such as the screw shown in the transit instrument fig. 41, page 188, for altering the position of the instrument by definite small quantities. Let  $m_0$  be the micrometer reading of the collimation centre of the instrument,  $m$  the reading of the star when bisected, if  $\mu$  be the value of one division of the screw,  $\mu(m - m_0)$  will be the distance of the star, call it  $c'$ , from the great circle described by the collimation centre. It is supposed that micrometer readings increase as the thread moves towards the circle-end of the axis. The method of arranging the observations would then be somewhat as follows, depending of course on circumstances of weather, &c.:

Circle East—Transit of a time star and two bisections of Polaris.

Circle West—Polaris, two time stars, and Polaris.

Circle East—Transit of a time star and bisections of Polaris.



These observations, supposed to constitute one complete time determination are to be accompanied by readings of the level.

The azimuth and zenith distance of Polaris are to be computed and tabulated for every five minutes of time during the period the star is under observation. Let  $T'$  be the reading of clock corresponding to the observation of Polaris,  $\tau$  an approximate value, as near as can be obtained, of the clock correction,  $\tau + \Delta\tau$  the real correction. Let the computed azimuth of the star corresponding to the time  $T' + \tau$  be  $a'_0$ , then if  $\beta$  be the change of azimuth for one second of time,  $a'_0 + \beta \cdot \Delta\tau$  will be the true azimuth of the star at the moment of observation. In the equation (3) replace  $a$  by  $90^\circ + a$ , when it becomes

$$c + b \cos z + \sin z \sin (a - a) = 0.$$

Thus, for the position circle east, we get for the pole star and the time star respectively,

$$\text{Pole star: } a = a'_0 + \beta \Delta\tau + \frac{b \cos z'}{\sin z'} + \frac{c'}{\sin z'}.$$

$$\text{Time star: } a = 180^\circ + a + \frac{b \cos z}{\sin z} + \frac{c}{\sin z}.$$

It is supposed that the level error  $b$  does not change between the observation of the time star and of Polaris; also that  $c$  is the collimation error, either of the 'mean thread' or of the centre thread, according to the manner in which the transits have been reduced: generally the reductions are made to the centre thread. The hour angle  $h$  of the time star and the azimuth are connected by the relation

$$\cos \delta \sin h = -\sin z \sin a;$$

$$\therefore \cos \delta \sin h = \sin z \sin a + (b \cos z + c) \cos a. \quad (10)$$

If we put  $a_0 = a'_0 + c' \operatorname{cosec} z'$ , and

$$\cos \delta \sin h_0 = \sin z \sin a_0, \quad (11)$$

the difference of (10) and (11) gives

$$\cos \delta \cos h (h - h_0) = \sin z \cos a (a - a_0) + (b \cos z + c) \cos a;$$

$$\therefore h = h_0 + b \frac{\sin (z + z')}{\cos \delta \sin z'} + \frac{c}{\cos \delta} + \frac{\beta \Delta\tau \sin z}{\cos \delta},$$

where the factor  $\cos a : \cos h$  has been replaced by unity. If

$T$  be the observed time of transit of the star, and  $A$  its right ascension,  $T + \tau + \Delta\tau - A = \frac{1}{15} h$ . Hence, finally,

$$\gamma \cdot \Delta\tau = A - T - \tau + \frac{1}{15} h_0 + b \sec \phi + c \sec \delta, \quad (12)$$

where  $\gamma = 1 - \frac{1}{15} \beta \sin z \sec \delta$ , and  $b, c$  are expressed in seconds of time. The zenith distance of the time star is given by

$$z = \phi - \delta + \frac{1}{2} a^2 \sin(\phi - \delta) \cos \phi \sec \delta \cdot \sin 1'', \quad (13)$$

where the azimuth  $a$  is expressed in seconds.

The formula (6) for the reduction of the time of transit over a side thread at the distance  $c$  from the centre thread gives in this case

$$\frac{1}{15} c \{ \sec(\delta + n) \sec(\delta - n) \}^{\frac{1}{2}}, \text{ where } n = a \cos \phi.$$

The subject is fully treated in an essay entitled *Die Zeitbestimmung vermittelt des tragbaren Durchgangsinstruments im Verticale des Polarsterns*, von W. Döllen, St. Petersburg. The method of reduction of the observations given above is virtually that adopted in the operations of determining the difference of longitude of Poulkowa (St. Petersburg), Stockholm, and intermediate stations. *Mem. Acad. Imp. Sci. St. Petersbourg*, Tome XVII, Nos. 1 and 10.

## 5.

If the vertical plane described by a transit instrument freed from level and collimation error be intersected once by the diurnal path of a star, it will be intersected a second time. Let  $h, h'$  be the hour angles corresponding to the two times of transit, then by (5)

$$\begin{aligned} -\cos a \cos \phi \sin \delta + \cos a \sin \phi \cos \delta \cos h, \\ + \sin a \cos \delta \sin h, &= 0, \\ -\cos a \cos \phi \sin \delta + \cos a \sin \phi \cos \delta \cos h' \\ + \sin a \cos \delta \sin h' &= 0; \end{aligned}$$

and from these we have

$$\begin{aligned} \tan \delta \cos \frac{1}{2}(h, + h') &= \tan \phi \cos \frac{1}{2}(h, - h'), \\ \tan a &= \sin \phi \tan \frac{1}{2}(h, + h'). \end{aligned} \quad (14)$$

If the times of transit of a star be observed, giving  $h, h'$  and

$h'$ , the first equation gives a value of the latitude, and the second the azimuth of the plane. When the instrument is in the prime vertical,  $a = 0$ , and  $h + h' = 0$ ; if therefore  $h$  be the hour angle of the star at either transit,  $\tan \phi = \tan \delta \sec h$ . The method of determining latitudes by observations of the transits of stars over the prime vertical was originated by Bessel. A great advantage is the facility it offers for the elimination of instrumental errors by the reversal of the telescope either between the observations of two stars, or even in the middle of the transit of a star, or by using the instrument circle north one night and circle south the next. But the disadvantage is that the method demands a very precise knowledge of the time, and it is better suited to high latitudes than to low ones. The error  $d\phi$  of latitude, as depending on errors of  $\delta$  and  $h$ , is given by the equation

$$\frac{2d\phi}{\sin 2\phi} = \tan h d\delta + \frac{2d\delta}{\sin 2\delta},$$

which shows that the hour angle, or the zenith distance of the star when observed, should be as small as possible.

The equation (5), if we make  $a$  a very small angle, applies to the case of transits in the prime vertical. Here  $b$  is positive when the northern end of the axis is high. Putting

$$\cos a = 1, \text{ and } \cos \delta \sin h = -\sin z$$

(when the azimuth of the star is very nearly  $90^\circ$ ), our equation becomes

$$a \sin z + b \cos z + c + \cos \phi \sin \delta - \sin \phi \cos \delta \cos h = 0. \quad (15)$$

Let  $\phi'$  be determined from the equation  $\tan \phi' = \tan \delta \sec h$ , then if  $\phi' - \phi = \epsilon$

$$\cos \phi \sin \delta - \sin \phi \cos \delta \cos h = \epsilon (\sin \phi \sin \delta + \cos \phi \cos \delta \cos h)$$

but the quantity within the last parenthesis is  $\cos z$ ; hence

$$\phi = \phi' + a \tan z + b + c \sec z, \quad (16)$$

an equation which can be verified geometrically:  $z$  must be taken negatively for western transits.

When the observed star is near the zenith there is time to reverse the instrument in the middle of the transit. Thus a star may be observed at its eastern transit on the north

side of the prime vertical upon those threads which are to the south of the collimation centre; then, after reversing the instrument, the star may be observed again on the same threads. Leaving the telescope in the last position until the star comes to the western transit, it is observed again on the same threads to the south of the prime vertical, and then reversing the telescope the star again crosses the same threads on the north side. Thus each thread gives a latitude determination freed from instrumental errors. Let  $I$  be the angle corresponding to the interval of time between two transits over one thread on the north side,  $I'$  that corresponding to the observations on the same thread on the south side,  $H$  corresponding to the difference between the star's right ascension and the mean of the four times of transit, then either by (15) or geometrically, we get

$$\cot(\phi - \delta) = \cot \delta \cos \frac{1}{2}(I + I') \cos \frac{1}{2}(I' - I) \sec H. \quad (17)$$

But practically this requires rather too many reversals of the instrument. It is probably best to select a number of stars for which  $\phi - \delta$  does not exceed  $2^\circ$ , such that they can be observed first on the east side of the zenith, circle N. say, and again on the western side, circle S. Then on the next night in the positions E. circle S. and W. circle N.

For this case of very small values of  $\phi - \delta$ , if we put  $e$  for  $\frac{1}{2}(\phi - \delta)^2 \operatorname{cosec} 1''$ , and calculate  $e$ , which will be less than  $1''.5$ , from an approximately known value of  $\phi$ , then the equation (15) may for the two observations of the star E. and W. be written thus for each thread:

$$\phi - \delta - c = \frac{2}{\sin 1''} \sin \phi \cos \delta \sin^2 \frac{h}{2} + a \sin z + b \cos z + e,$$

$$\phi - \delta + c = \frac{2}{\sin 1''} \sin \phi \cos \delta \sin^2 \frac{h'}{2} + a \sin z' + b' \cos z' + e,$$

where the unit is  $1''$ . From the mean of these  $c$  is eliminated, and since  $z'$  differs but little from  $-z$ ,  $a$  enters with a small coefficient. The value of  $a$  for the evening's work may be obtained thus: suppose the two equations just written down to appertain to the centre thread, then  $a$  and  $c$  remaining symbolical, the difference of the equations will give one of the form  $c + a \sin z = g$ . Each star will give one such equation.

## 6.

The determination of latitudes for geodetic purposes is effected by one or other of the following methods: (1) determinations of the meridian zenith distances of stars; (2) by zenith distances of Polaris, a method which has the advantage that the observations may be made at any part of the star's apparent orbit, and by day as well as by night; (3) by transits in the prime vertical; (4) by the zenith telescope.

In the first method it is desirable that stars be observed equally on both sides of the zenith, so that in the end the mean of the zenith distances may be nearly zero. When the star is observed at a small hour angle from the meridian—which should not be done in the case of stars near the zenith—if  $z'$  be the meridian distance,  $z$  the observed zenith distance,  $h$  the small hour angle from culmination, then

$$z' = z \pm \frac{2 \cos \phi \cos \delta \sin^2 \frac{1}{2} h}{\sin \frac{1}{2} (z' + z)}, \quad (18)$$

the upper sign applying to upper, the lower sign to lower culminations. This formula includes the term in  $h^4$ ; on the right side of the equation  $z'$  is to be obtained from the approximately known latitude.

In the hands of an expert observer it is certain that very excellent results for latitude can be obtained from small circles. The latitudes of the greater part of the stations in the Russian arc were determined with circles of 11 inches and 14 inches diameter. We have described the instrument used in the Spanish geodetic operations. The following results for latitude at three different stations by three different methods are interesting:

METHOD.	CONJUBOS, 36° 44'.		DIEGO GOMEZ, 40° 55'.		LLATIAS, 43° 29'.	
	No. of Days.	Seconds of Latitude.	No. of Days.	Seconds of Latitude.	No. of Days.	Seconds of Latitude.
Polaris ... ..	5	22.41 ± .10	5	39.11 ± .10	5	28.78 ± .10
Other stars ...	9	21.99 ± .10	5	38.26 ± .07	5	29.02 ± .10
Prime Vertical	6	22.43 ± .12	6	38.42 ± .12	4	29.45 ± .13

In the case of the second station there is a difference between the results given by the first and second methods amounting to  $0''\cdot85$ . This, however, is not much greater than the difference between the latitudes of Balta as obtained from the zenith sectors of Ramsden and Airy.

In the zenith telescope let us suppose the micrometer readings to increase as the zenith distance decreases. The instrument being set, approximately, to the mean zenith distance of a pair of stars about to be observed, and the level indication being zero, let  $z_0$  be the angle made with the vertical by a line joining the optical centre of the object glass with a point in the centre of the field whose micrometer reading is  $m_0$ . It is presumed that during the short period of time required to observe a pair of stars the relation of the level and telescope remain unchanged; hence, if when one of the stars—as the north star—is observed, the north end of the level has the reading  $n$ , while the southern has the reading  $s$ , then the zenith distance of the point  $m_0$  is  $z_0 + \frac{1}{2}(s-n)$ , the level readings being converted into angular measure. Let

$\delta'$   $\delta$ , be the declinations of N. star and of S. star.

$m'$   $m$ , micrometer readings of N. star and of S. star.

$R'$   $R$ , refractions for N. star and for S. star.

$n'$   $s'$  level readings for N. star.

$n$ ,  $s$ , „ „ „ S. star.

$\mu$   $\lambda$  angular values of one division of micrometer and level.

Then the apparent zenith distances of the stars are

$$\begin{aligned} N \dots \delta' - \phi - R' &= z_0 + \frac{1}{2}\lambda(s' - n') + (m_0 - m')\mu, \\ S \dots -\delta + \phi - R &= z_0 - \frac{1}{2}\lambda(s, - n,) + (m_0 - m,)\mu; \end{aligned} \quad (19)$$

and eliminating  $z_0$  and  $m_0$ ,

$$\phi = \frac{1}{2}(\delta' + \delta,) + \frac{1}{2}\mu(m' - m,) + \frac{1}{2}\lambda(n' - s' + n, - s,) - \frac{1}{2}(R' - R). \quad (20)$$

Here it is supposed that the observation is made on the centre thread, and that the instrument is in the plane of the meridian. If the micrometer bisection is made when the star is on a side thread at a distance  $c$  from the centre thread, the correction  $\pm \frac{1}{2}c^2 \tan \delta$  is required to the zenith distance; the

upper sign for south stars, the under sign for north stars. Thus the above expression for  $\phi$  requires the addition of  $+\frac{1}{2}(c' + c)$ , where  $c'$ ,  $c$ , are the corrections on the north and south stars respectively.

If a star be followed with the instrument out of the plane of the meridian and observed on the centre thread, a correction of the form (18) is required.

For determining the value of  $\mu$ , the instrument is set to the zenith distance of the pole star at its greatest azimuth, and directed to the star half-an-hour or so before the time of greatest azimuth. The micrometer screw is set at successive single revolutions in advance of the star, and the corresponding times of vertical transit observed; the level is also read at each transit. Let  $z'$  be the zenith distance of the star at one of these observations,  $\zeta$  being that at the time of greatest azimuth. If  $R$  be the refraction corresponding to  $\zeta$  we may put

$$R' - R = \beta(z' - \zeta);$$

also in the first of equations (19) put  $z_0 + R = \zeta - x$ , and write  $z'$  for  $\delta' - \phi$ , then expressing  $z' - \zeta$  in seconds,

$$\mu(m' - m_0) + x + (z' - \zeta)(1 - \beta) + \frac{1}{2}\lambda(n' - s') = 0.$$

Each observed transit gives an equation of condition of this form. The solution by least squares is simplified by substituting  $M + y$  for the unknown  $\mu$ , where  $M$  is an approximate value, and  $y$  the required correction:  $z' - \zeta$  is easily calculated from the recorded time of observation. It is supposed in these formulæ that the instrument is used with the micrometer screw below, as represented in the drawing. It may, however, be used in the other position, in which case, the sign of  $\mu$  being changed, the formulæ still apply.

In the two instruments used on the Ordnance Survey the values of one revolution of the micrometers are

$$62''.356 \pm 0''.003 \quad \text{and} \quad 63''.325 \pm 0''.006,$$

derived in each case from the combined observations made at six stations.

The lists of stars prepared for these instruments comprised from thirty to fifty pairs for each night, and of these a considerable proportion were found in the Greenwich and Oxford Catalogues, though some stars were dependent on the British

Association Catalogue places. The following table contains the final results for latitude at the station, a summit of the Grampians, where the smallest number of stars was observed :

PAIRS.	JULY 1, 1868.	JULY 4, 1868.	JULY 6, 1868.
	56° 58'	56° 58'	56° 58'
I.	40.22	40.28	39.84
II.	...	41.46	40.26
III.	40.57	40.06	39.92
IV.	39.47	40.28	40.29
V.	39.34	...	40.54
VI.	...	...	40.60
IX.	41.63	...	41.40
X.	41.18	40.55	39.86
XI.	38.91	39.63	39.70
XII.	39.64	...	40.01
XIII.	39.94	...	39.01
XIV.	38.76	...	39.02
XV.	39.21	...	40.87
XVI.	40.37	...	...
XVII.	40.37	...	40.71
XVIII.	40.46	...	...
XIX.	...	...	40.33
Daily } Means }	40.01	40.38	40.16

Latitude 56° 58' 40".13 ± 0".08.

The simplicity of construction of the zenith telescope exempts it from several of the recognised sources of instrumental error, while its portability and ease of manipulation eminently fit it for geodetic purposes. It is exclusively adopted for latitudes in the United States, and it is probable that no one who has used it would return to graduated circles for latitude.

The form of the expression for the latitude as determined by the zenith telescope shows that the error of a single result is affected by the errors in the assumed declinations of two stars, by the errors of two bisections of these stars, and by errors in the assumed values of the micrometer and level divisions. The last two sources of error can be made very small. The discussion of a large number of observations



shows that the probable error of *observation only* in a single determination of latitude from a pair of stars is between

$$\pm 0''.35 \text{ and } \pm 0''.65,$$

according to the skill of the observer and the sensitiveness of the level of the instrument. Hence, if  $e, e'$  be the errors of the declinations of two stars, and they be observed  $n$  times, the error of the resulting latitude may be expressed by

$$\frac{1}{2}(e + e') \pm \frac{0''.50}{\sqrt{n}}.$$

If  $\epsilon, \epsilon'$  be the probable errors of the declinations, then the probable error of latitude resulting from  $n$  observations of this pair is

$$\pm \frac{1}{2} \left( \epsilon^2 + \epsilon'^2 + \frac{1.00}{n} \right)^{\frac{1}{2}}.$$

Hence, in combining the results given by pairs of stars, the weight to be given to each result may be taken as

$$\frac{n}{1 + n\epsilon^2 + n\epsilon'^2}.$$

The probable error of a declination will depend on the catalogue from which it is taken; from the Nautical Almanac or Greenwich Catalogues  $\epsilon$  may be about  $\pm 0''.5$ , but from the British Association Catalogue it would be probably double that amount.

In the official Report<sup>1</sup> on the North American Boundary, the subject is very fully discussed. In those operations the probable error of a single determination is in several cases less than  $\pm 0''.3$ .

## 7.

The method that has been generally followed for the determination of absolute azimuth in this country is the measurement of the horizontal angle between a terrestrial mark and a close circumpolar star, when at or near its position of greatest azimuth. The practice in other countries, as in Russia, in

<sup>1</sup> *Reports upon the Survey of the Boundary between the Territory of the United States and the Possessions of Great Britain.* Washington, 1878; pp. 95-169.

Spain, and in America differs from this only in that the observations are not always confined to the position of greatest azimuth of the star. The most frequently used star is Polaris, then  $\delta$ ,  $\epsilon$ , and  $\lambda$  Urs. Minoris, 51 Cephei, and others. The formula (4) shows that the level and collimation errors enter with large factors, large at least in high latitudes; therefore it is necessary to determine the collimation before and after the star observations, and the level must be read in reversed positions during the observations. The error of level must be scrupulously kept as small as possible, and the value of one division of the level should be known at all temperatures. The difference of pivots must be accurately known, but no instrument with irregular pivots is fit for this work. The terrestrial mark—not less than a mile off—is generally for night work a lamp behind a vertical slit: the opening is sometimes covered with oiled paper.

There are slight differences of detail in the modes of conducting the observations, but the following may be taken as virtually the ordinary procedure. The level being on the axis, and the instrument, say circle west: (1) the mark is observed; (2) the star is observed; (3) the level is read and reversed; (4) the star is observed a second time; (5) the level is read; (6) the mark is observed. The telescope is then reversed, and with circle east the operations just specified are repeated. The double operations complete one determination of the angle. The chronometer times of observation of the star are noted for the calculation of its azimuth. As in terrestrial observations the errors of graduation are eliminated by shifting the zero of the horizontal circle.

The probable error of a determination of azimuth increases with the latitude: it may be expressed by the formula

$$\epsilon = \pm \sqrt{a^2 + b^2 \tan^2 \phi}.$$

In the azimuth determinations by Struve in connection with his great arc of meridian, the probable error of a single determination (as just defined) increased from  $\pm 0''.75$  in latitude  $45^\circ$  to  $\pm 1''.98$  in Finmark. The determinations of azimuth in the recent geodetic operations in Spain, effected with theodolites of Repsold, are excellent. In the triangulation of Great Britain azimuths were determined at sixty stations;

at twelve of these the probable error of the final result is under  $\pm 0''.50$ , and at thirty-four, under  $\pm 0''.70$ . Generally speaking, in these observations the observer has had only an approximate knowledge of the time, and hence at each greatest azimuth of a star only a single determination was effected: each observation since the year 1844 has been corrected for level and collimation errors. At fifty-seven stations out of the sixty the observations were made by N. C. Officers of Royal Engineers.

In Colonel Everest's work in India it was the rule to take four measures circle east and four circle west, at each zero, on each side of the pole: the number of zeros was four, making in all sixty-four measures as sufficient. But this number was often exceeded.

Another method of determining absolute azimuths is by erecting a mark either to the east or west of north—or one to the east and another to the west—in such positions that the pole star shall cross the vertical circle of the mark a little before and a little after its greatest azimuth. The observations are made with a transit instrument furnished with a moveable vertical thread for micrometer measurements. The instrument is set with the centre thread nearly on the mark, then the telescope being elevated to the star at the proper time, the star will move slowly across the field. Readings of the micrometer thread—on the mark, the star, the star, the mark are taken, and combined with level readings in reversed positions. This operation is repeated in the alternate positions of the instrument circle east, circle west. The observations should be so arranged that the star is taken as much on one side of the field as on the other; thus the final result will be nearly independent of the assumed value of a division of the micrometer.

Let  $\mu_0$  be the micrometer reading of the collimation centre,  $\mu$  that of the star,  $\mu'$  that of the mark: suppose these readings to increase as the thread moves towards the circle end of the axis: also let  $d$  be the angular value of a micrometer division, then in accordance with equation (3) we have

$$\begin{aligned}(\mu - \mu_0) d + b \cos z + \sin z \cos (a - a) &= 0, \\(\mu' - \mu_0) d + b \cos z' + \sin z' \cos (a' - a) &= 0;\end{aligned}$$

and hence, since  $a - a'$  is only a few minutes,

$$a' = a - \frac{(\mu - \mu_0)d}{\sin z} + \frac{(\mu' - \mu_0)d}{\sin z'} - b \frac{\sin(z' - z)}{\sin z \sin z'}. \quad (21)$$

The following table contains the results for azimuth at a station in Elginshire, in latitude  $57^\circ 35'$ ; the observations were made with the Russian transit instrument previously alluded to. Each figure is a complete single determination, including both positions of the instrument, in the manner described:—

1868.		NORTH WEST MARK.			Az. $177^\circ 45' .a.$	
Oct. 14.	Oct. 16.	Oct. 17.	Oct. 18.	Oct. 20.	Oct. 25.	Oct. 26.
"	"	"	"	"	"	"
37.11	38.46	39.88	38.79	36.50	37.14	37.98
36.50	37.21	38.90		35.13	35.85	39.13
	37.21			38.43	38.08	37.65
					36.98	
		NORTH EAST MARK.			Az. $182^\circ 17' \dots$	
Oct. 16.	Oct. 17.	Oct. 20.	Oct. 21.	Oct. 23.	Oct. 25.	
"	"	"	"	"	"	
15.13	15.04	14.01	16.31	16.40	14.89	
15.75	16.13	15.36		15.66	14.83	
		15.40		15.29	14.50	
				14.99	15.64	
				14.67	16.97	
				15.00		

Hence we have the azimuths—reckoned from the south,

North West Mark ...  $177^\circ 45' 37'' .61 \pm 0'' .19.$

North East Mark ...  $182^\circ 17' 15'' .37 \pm 0'' .11.$

In the case of the first mark the probable error of a complete single determination is  $\pm 0'' .820$ , and for the second it is  $\pm 0'' .489$ . The difference in the precision of the results is due to the circumstance that the former mark was observed in the morning twilight, sometimes with a lamp, and with difficulty; the latter mark was observed in good daylight in the afternoon. The observations were made (in stormy

weather at a height of 1100 feet) by Quarter-Master Steel and Serjeant Buckle, R. E., and indicate both expertness in the observers and perfection in the instrument.

If in connection with the observation of the star its reflection in an artificial horizon be observed, then the level may be dispensed with, unless indeed the zenith distance of the mark differ materially from  $90^\circ$ . As the spherical co-ordinates of the star are  $a$  and  $z$ , so those of its reflected image are  $a$  and  $180^\circ - z$ ; and if  $\mu, \mu_1$  be the readings of the star and of its reflection,

$$\begin{aligned} & (\mu - \mu_0) d + b \cos z + \sin z \cos(a - a) = 0, \\ & (\mu_1 - \mu_0) d - b \cos z + \sin z \cos(a - a) = 0, \end{aligned}$$

neglecting the small change of zenith distance between the two observations. From the mean of these  $b$  disappears as far as the star is concerned, and

$$a' = a + \frac{\mu' - \mu_0}{\sin z'} d - \frac{\frac{1}{2}(\mu + \mu_1) - \mu_0}{\sin z} d + b \cot z'.$$

The azimuth of a circumpolar star at any point of its path may be obtained from the formula

$$\frac{\tan a}{\tan A} = \frac{\sin H \sin h}{1 - \cos H \cos h}, \quad (22)$$

where  $H$  is the hour angle corresponding to the maximum azimuth  $A$ . Or if the observations of the star are confined to times within an hour of the greatest azimuth, the formula (23), page 46, is sufficiently accurate—and even in this, if the star be within 20 minutes or so of its greatest azimuth (this depends on the latitude of the observer) the denominator of the right side of the equation may be replaced by unity.

The azimuth obtained from observations of the pole star requires the correction  $\pm 0''.311$  on account of diurnal aberration.

## 8.

For the determination of the difference of longitudes of two stations for geodetic purposes the lunar methods are not sufficiently precise. The requirements of the case are in one

sense simple: the correct keeping of the time at *A*, the same at *B*, and some means of comparing simultaneous readings of the clocks at *A* and *B*. The extended system of electric telegraphs, now in use in all countries, affords the most precise mode of comparing local times: the details of the method will be found in the *U. S. C. Survey Reports* for 1857, 1867, 1874; in the *Reports of the Surveyor-General of India*; in the *Annales de l'observatoire Impérial de Paris*, vol. viii; the *Mé-morial du Dépôt général de la Guerre*, vol. xi; the *Publication des Königl. Preussischen Geodätischen Instituts*, Berlin, 1876; and other works.

The method of recording time and astronomical observations on a revolving cylinder originated in the U. S. C. Survey in the first attempt to determine longitude by electro-magnetic signals. Bond's chronographic register is a cylinder of about twelve inches long by six inches diameter: it revolves once per minute, a uniformity of velocity being secured by a centrifugal fly-regulator in connection with a pendulum. As the cylinder revolves it is drawn uniformly along a screw-formed axis: its surface is covered with paper, removeable at pleasure, and a pen held in contact with the paper under the influence of an electro-magnet draws on the paper a continuous spiral. The galvanic circuit passing through the clock is broken every second by the clock: this break, the duration of which is regulated to about one twentieth of a second, demagnetises the electro-magnet, and the pen under the influence of a spring draws a small offset at right angles to the continuous spiral: thus the beats of the clock are transformed from audible to visible intervals or signals. The manner in which the clock breaks the circuit will be understood from the adjoining figure, in which *PP* is the pendulum-rod, *B* a brass plate carried by the back of the clock-case from which projects a brass arm carrying an ivory bracket *I*. To this is affixed and adjusted a very small tilt-hammer of

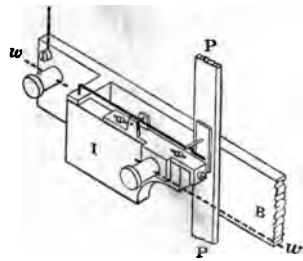

Fig. 43.

from the adjoining figure, in which *PP* is the pendulum-rod, *B* a brass plate carried by the back of the clock-case from which projects a brass arm carrying an ivory bracket *I*. To this is affixed and adjusted a very small tilt-hammer of

platinum, of which the left hand end rests on a metal disk plated with platinum, connected with *B* and the line wire *w*. A fine pin projecting from the pendulum rod strikes the obtuse angle of a small bend in the tilt-hammer, and for an instant as the pendulum passes its lowest position tilts up the left end of the hammer, so breaking the circuit.

A signal key under the hand of the observer enables him also at pleasure to break the circuit in the same manner as does the clock; thus, the instant of a star passing a thread of the transit instrument is recorded on the chronograph by an offset. The offset of the observer is readily distinguished from that of the clock by a difference of form. A small portion of the register has something of this appearance—



Fig. 44.

It is the breaking of circuit whether by clock or observer that constitutes a signal, hence, in reading off the chronographic record it is the right hand or first edge of the offset that is used in subdividing the seconds. In order to facilitate the reading of the time, one second, viz. that numbered 60 is omitted in the chronograph every minute, and also two seconds are omitted every five minutes. This omission is effected by means of a very ingenious arrangement whereby the clock itself completes the circuit at those instants.

To determine the difference of longitude of two stations, *A* and *B*, there must be at each an astronomical clock, a chronograph and a transit instrument. The transit instruments used—with the most excellent results—in Paris and Algiers, for the recent determination of the difference of longitude of those places have telescopes of 31 inches focal length and 2.5 inches aperture; they are in fact meridian circles, the diameter of the circle being 16 inches. Those used in India are much larger, viz. 5 feet focal length of telescope with 5 inches aperture, but it is certain that the precision of results does not keep pace with increase of dimensions. From a discussion of a very large number of observed transits in the U. S. C. Survey it was ascertained that the probable error of

an observed transit (chronographic registry) over a single thread, the star's declination being  $\delta$ , was expressed by

$$\epsilon = \pm \left( (0.063)^2 + (0.036)^2 \tan^2 \delta \right)^{\frac{1}{2}}$$

or

$$\epsilon = \pm \left( (0.080)^2 + (0.063)^2 \tan^2 \delta \right)^{\frac{1}{2}},$$

the former applying to instruments of about 47 inches focal length, the latter to a focal length of 26 inches.

A much more formidable source of error is 'personal equation.' Every observer has his own peculiarity of habit in observing and recording transits which takes the form of a 'personal error.' In the eye and ear method a certain small error exists in associating the position of the star in the field with the audible beats of the clock, the eye and ear not acting in simultaneous accord: moreover, this may be combined with an erroneous habit of subdividing seconds. It is probably due in part to the same species of error of vision which will cause one observer with a microscope to bisect a line on a standard measure differently from the bisection of another observer, a difference which is tolerably persistent. In the chronographic method of recording observations, personal error also exists, referrible to peculiarity of vision and manner of touching the signal key. Personal error may be affected by the brightness of a star and its velocity, it certainly is affected by its direction of movement, north stars and south stars giving for some observers different personal errors. In those instruments in which the rays of light are turned through a right angle by a central prism, the personal error has been found to be different in the two positions, east and west, of the eye-piece.

The investigation of personal error is therefore one of the most important elements in the question of longitudes. The ordinarily practised method of ascertaining relative personal error of two observers, *A* and *B*, is this: they observe transits of the same star in the same instrument. *A* observes the first star over all the threads before it arrives at the centre, *B* then observes the same star over all the remaining threads. For the next star, *B* observes in the first half of the field, *A* in the second half, and so on alternately. The observation in



this manner of a large number of stars, in which those north of the zenith are to be separated from those south of the zenith gives the difference of the personal equations of *A* and *B*. Unfortunately personal equation is not altogether constant, depending on the nervous condition or state of health of the observer.

The threads in transit instruments used with chronograph registry are generally numerous—for instance, they are often arranged in five groups of five, the members of a group being at the equatorial interval of  $2^{\circ}.5$ : in fine weather the three centre groups are found sufficient for observing.

Supposing the apparatus and instruments to be in perfect adjustment, the observations for longitude each evening are preceded by observations of transits for the determination of instrumental errors and clock error: say six or eight zenith stars with one or two circumpolars and two reversals of the instrument. The clock at the eastern station *A* is then put in connection with the circuit and graduates the chronograph at *A* and the chronograph at *B*. The observer at *A* on the arrival of the first star on the list of signal stars made out for the longitude work, observes its transit, his signal key marking it both on the chronograph at *A* and on that at *B*. On reaching the meridian of *B* the same star is observed in the transit instrument there and is recorded by the observer on the chronograph at *B* and on that at *A*: and so for the other stars. When half the evening's work is done the clock *A* is disconnected from the circuit and replaced by that at *B*.

Each star gives thus a difference of longitude on each chronograph, a result independent of the star's place. The difference of longitude given by the western chronograph will be too small by the interval of time occupied in transmission of the signals, that at the eastern will be too great by the same amount. Hence, in taking the mean of the two chronographic results this small interval is eliminated, provided the strength of the batteries has been kept constant. But the result is still affected with personal error of the observers. This may be eliminated by the interchange of observers when the station is half completed.

When the stations are very far apart this method becomes

impracticable, and the following is that adopted. After the necessary observations have been made for the determination of clock error at each station, the eastern clock is first put into connection with the circuit, so as to graduate both chronographs: then that at the western is put into circuit and also graduates both chronographs. The western chronograph will give the longitude too small by transmission time, the eastern gives it too large by the same amount. The observers, each with his own instrument and apparatus, are collected (either after or before, or both) into one spot, and determine the difference of longitude of their respective instruments.

In a very interesting account by J. E. Hilgard, Esq. of the transatlantic longitude work in 1872, we find the following statement of the results of three determinations of the longitude of Harvard College Observatory, Cambridge, U. S., west of Greenwich :

		h.	m.	s.	s.
By Anglo-American cables in	1866 ...	4	44	30.99	$\pm 0.10$ .
By French cable to Duxbury in	1870 ...	,,	,,	30.98	$\pm 0.06$ .
By French cable to St. Pierre in	1872 ...	,,	,,	30.98	$\pm 0.04$ .

A very extensive series of longitude determinations has been carried out recently in India with most admirable precision under the direction of M.-General Walker, C.B., F.R.S., Surveyor-General of India. In his yearly report for 1877-78 are found the results of eleven differences of longitude by electro-telegraphy with the corresponding geodetic differences. They are between Bombay (*B*) and Mangalore (*N*) on the west coast, Vizagapatam (*V*) and Madras (*M*) on east coast, and Hyderabad (*H*), Bangalore (*R*), and Bellary (*L*) in the interior.

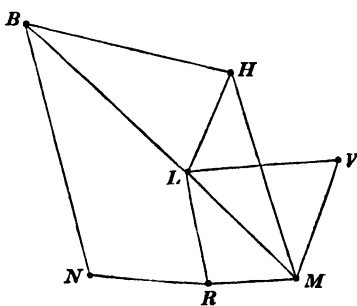

Fig. 45.

The eleven lines observed are drawn in the diagram. In every triangle it will be noted there is a check on the accuracy of

the work: thus, referring to difference of longitude, the triangle  $LRM$  gives  $LM = LR + RM$ . 'When the operations were commenced,' says General Walker, 'I determined that they should be carried on with great caution, and in such a manner as to be self-verificatory, in order that some more satisfactory estimate might be formed of the magnitudes of the errors to which they are liable than would be afforded by the theoretical probable errors of the observations. . . the simplest arrangement appeared to be to select three trigonometrical stations  $A, B, C$ , at nearly equal distances apart on a telegraphic line forming a circuit, and after having measured the longitudinal arcs corresponding to  $AB$  and  $BC$  to measure  $AC$  independently as a check on the other two.' The following table contains the observed differences of longitude:—

YEAR.	ARC.	OBSERVED DIFF. OF LONGITUDE.	CORRECTIONS.
1872-73	Madras—Bangalore ...	2 39 45.63	$x_1 = + 2.010$
"	Bangalore—Mangalore ...	2 44 11.54	$x_2 = + 1.690$
1875-76	Hydrabad—Bombay ...	5 42 12.74	$x_3 = - 0.452$
"	Bellary—Bombay ...	4 6 44.39	$x_4 = - 0.393$
"	Hydrabad—Bellary ...	1 35 28.25	$x_5 = + 0.040$
"	Madras—Hydrabad ...	1 43 40.38	$x_6 = - 0.412$
"	Madras—Bellary ...	3 19 8.45	$x_7 = - 0.192$
"	Bangalore—Bellary ...	0 39 20.46	$x_8 = + 0.160$
1876-77	Vizagapatam—Madras ...	3 2 26.78	$x_9 = + 0.401$
"	Vizagapatam—Bellary ...	6 21 35.84	$x_{10} = - 0.401$
"	Mangalore—Bombay ...	2 1 50.54	$x_{11} = + 0.845$

The first two determinations were the earliest made, and are affected with some fault in one of the transit instruments not fully known at the time, hence these have less weight than the others.

With respect to the corrections in the last column, these arise in the following manner: it will be seen that the figure presents four triangles and a quadrilateral, each of these five presents a condition to be fulfilled by the observed longitudes. Suppose that in consequence of errors in the concluded results

they require corrections  $x_1, x_2 \dots x_{11}$  in the order in which they are written down. Take for instance the triangle  $BLH$ , the sum of the fourth and fifth observed differences of longitude should be equal to the third, that is,

$$5^\circ 42' 12''.64 + x_4 + x_5 = 5^\circ 42' 12''.74 + x_3;$$

hence a linear relation between  $x_3, x_4$ , and  $x_5$ . The following equations can be thus verified :

$$\begin{aligned} x_1 - x_7 + x_8 - 2.36 &= 0, \\ x_7 + x_9 - x_{10} - 0.61 &= 0, \\ x_5 + x_6 - x_7 + 0.18 &= 0, \\ -x_3 + x_4 + x_5 - 0.10 &= 0, \\ -x_2 + x_4 + x_8 - x_{11} + 2.77 &= 0. \end{aligned} \tag{23}$$

Now the  $x$ 's cannot be determined from these equations. But the theory of probabilities shows that the values which are the most probable are those which, in addition to the conditions above, make the function

$$a_1 x_1^2 + a_2 x_2^2 + x_3^2 + \dots x_{11}^2$$

a minimum. Here the symbols  $a_1, a_2$  are the weights of the first two determinations, those of the remaining nine being taken as unity. We cannot assign precise values to  $a_1, a_2$ , we shall assume them to be each  $= \frac{1}{2}$ .

Proceeding by the ordinary method of the differential calculus, multiply the equations (23) severally by indeterminate multipliers  $u_1, u_2 \dots u_5$ , then we get

$$x_1 = 2u_1, \quad x_2 = -2u_5, \quad x_3 = -u_4,$$

and so on. Substitute the equivalents of  $x_1 \dots x_{11}$  so expressed in terms of  $u_1 \dots u_5$  in the equations (23), they are thus transformed to

$$\begin{aligned} 4u_1 - u_2 + u_3 \dots \dots + u_5 - 2.36 &= 0, \\ -u_1 + 3u_2 - u_3 & \quad \quad \quad -0.61 = 0, \\ u_1 - u_2 + 3u_3 + u_4 & \quad \quad \quad +0.18 = 0, \\ & \quad \quad \quad u_3 + 3u_4 + u_5 - 0.10 = 0, \\ u_1 \dots \dots \dots + u_4 + 5u_5 + 2.77 &= 0. \end{aligned} \tag{24}$$

Solving these equations we get numerical values of  $u_1 \dots u_5$ , whence immediately follow those of  $x_1 \dots x_{11}$ . These are written down in the last column of the table.

The smallness of the corrections is abundant proof of the

remarkable precision attained in these observed differences of longitude.

In volume xi. of the *Mém. du Dép. gén. de la Guerre* will be found a valuable account, in full detail, by M. le Commandant Perrier of the operations for determining the difference of longitude of Paris and Algiers by means of the submarine cable connecting Algiers and Marseilles: the daily results collected at page 167 stand thus:

	m.	s.	s.		m.	s.	s.
Nov. 2,	2	50.372	$\pm 0.049$ ;	Nov. 17,	2	50.355	$\pm 0.021$ ;
„ 3,	2	50.284	$\pm 0.050$ ;	„ 23,	2	50.318	$\pm 0.25$ ;
„ 6,	2	50.298	$\pm 0.047$ ;	„ 24,	2	50.295	$\pm 0.025$ ;
„ 7,	2	50.338	$\pm 0.046$ ;	Mean,	2	50.326	$\pm 0.010$ .

This result requires the correction of  $-0^{\circ}.093$  for personal errors of the observers. Hence the difference of longitude is  $2^m 50^s.233$ . A check upon this is afforded by the independently observed differences of Paris—Marseilles

$$12^m 13^s.435 \pm 0^s.011,$$

and Marseilles—Algiers

$$9^m 23^s.219 \pm 0^s.011,$$

of which the difference is  $2^m 50^s.216 \pm 0^s.016$ , differing only  $0^s.017$  from the direct result.

## CHAPTER IX.

### CALCULATION OF TRIANGULATION.

IF the observed angles of a triangulation were exempt from error, the calculation of the distances between pairs of points would present no difficulty. But the errors with which every observed angle is burdened lead to conflicting results, and it becomes necessary to find a systematic method of treating these errors. In the case of a single triangle, if the three angles were equally well observed, and if the sum of those angles exhibited an error of, for instance,  $+3''$ , we should naturally and rightly apply to each observed angle the correction  $-1''$ : or if they are observed with unequal precision then we know by the method explained in the chapter on least squares how to divide the error among the angles. Still this applies generally only to isolated triangles, and it will be necessary to consider other combinations of points and angles.

#### 1.

Consider first a polygon of  $i$  sides represented in the annexed figure. Suppose that each angle in each of the  $i$  triangles is observed with an equal degree of precision. In each triangle the sum of the observed angles will show a certain amount of error, also in adding up the angles at the central point  $P$  the sum will differ slightly from  $360^\circ$ . Moreover, if

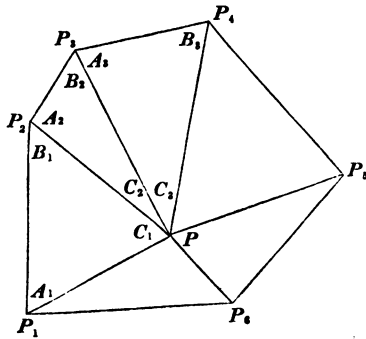

Fig. 46.

we start with the side  $PP_1$ , and calculate in succession the sides  $PP_2, PP_3, \dots PP_i$ , finally returning to  $PP_1$  we shall find a difference between the length of  $PP_1$  so calculated and that with which the calculation was commenced. This numerical difference is a function of the errors of observations: we have in fact  $i+2$  numerical values of as many functions of the  $3i$  observed angles. We shall adopt the following notation—

- $A_1, B_1, C_1$  the true angles of the first triangle;  
 $A'_1, B'_1, C'_1$  the observed angles of the same;  
 $e_1, f_1, g_1$  the corresponding errors of observation;  
 $x_1, y_1, z_1$  the corrections to be computed;  
 $\mathfrak{A}_1, \mathfrak{B}_1, \mathfrak{C}_1$  the finally adopted angles.

For the  $n^{\text{th}}$  triangle the subscript unity is replaced by  $n$ . Thus

$$\begin{aligned} A'_n &= A_n + e_n, & \mathfrak{A}_n &= A_n + e_n + x_n, \\ B'_n &= B_n + f_n, & \mathfrak{B}_n &= B_n + f_n + y_n, \\ C'_n &= C_n + g_n, & \mathfrak{C}_n &= C_n + g_n + z_n. \end{aligned}$$

We propose to investigate the most probable values of the corrections which should be applied to the observed angles.

Put  $a_1, \beta_1, \gamma_1$  for the cotangents of  $A_1, B_1, C_1$ , and further let

$$2a_1 + \beta_1 = a_1, \quad -a_1 - 2\beta_1 = b_1, \quad -a_1 + \beta_1 = c_1,$$

so that  $a_1 + b_1 + c_1 = 0$ . In the  $n^{\text{th}}$  triangle let the sum of the observed angles exceed the true sum by  $\epsilon_n$ , also let the sum of the observed angles at  $P$  be  $360^\circ + \epsilon_0$ . Then we have

$$e_n + f_n + g_n = \epsilon_n, \quad g_1 + g_2 + \dots + g_i = \epsilon_0, \quad (1)$$

in all  $i+1$  equations. We may express each  $g$  in terms of the corresponding  $e$  and  $f$ , and substituting in the last equation it becomes

$$e_1 + f_1 + e_2 + f_2 + \dots + e_i + f_i = -\epsilon_0 + \epsilon_1 + \epsilon_2 + \dots + \epsilon_i. \quad (2)$$

Then we have the further geometrical condition

$$\frac{PP_1}{PP_2} \cdot \frac{PP_2}{PP_3} \dots \frac{PP_i}{PP_1} = \frac{\sin B_1}{\sin A_1} \cdot \frac{\sin B_2}{\sin A_2} \dots \frac{\sin B_i}{\sin A_i},$$

each side of this equation being unity (in spherical triangles we have merely to write on the left side  $\sin PP_1$  instead of

$PP_1$ , &c.). The observed angles however will not fulfil this condition. Suppose the calculation made with the angles  $A'$ ,  $B'$ ... , and that the result is

$$\frac{\sin B'_1 \sin B'_2 \dots \sin B'_i}{\sin A'_1 \sin A'_2 \dots \sin A'_i} = 1 + \epsilon,$$

where  $\epsilon$  is a very small quantity. Then since

$$\frac{\sin B'_1}{\sin A'_1} = \frac{\sin B_1 (1 + \beta_1 f_1)}{\sin A_1 (1 + \alpha_1 e_1)} = (1 - \alpha_1 e_1 + \beta_1 f_1) \frac{\sin B_1}{\sin A_1},$$

it will follow that

$$-\alpha_1 e_1 + \beta_1 f_1 - \alpha_2 e_2 + \beta_2 f_2 - \dots - \alpha_i e_i + \beta_i f_i = \epsilon. \tag{3}$$

Now since the adopted angles  $\mathfrak{A}$ ,  $\mathfrak{B}$ ,  $\mathfrak{C}$  are to fulfil all the requirements of the case, it follows from (2) and (3) that

$$\begin{aligned} x_1 + y_1 + x_2 + y_2 + \dots x_i + y_i &= \epsilon_0 - \epsilon_1 - \epsilon_2 \dots - \epsilon_i, \\ -\alpha_1 x_1 + \beta_1 y_1 - \alpha_2 x_2 + \beta_2 y_2 - \dots - \alpha_i x_i + \beta_i y_i &= -\epsilon; \end{aligned} \tag{4}$$

and also from (1)

$$x_n + y_n + z_n + \epsilon_n = 0, \quad z_1 + z_2 + \dots z_i + \epsilon_0 = 0.$$

We have now to find such values of  $x_1, y_1, x_2, y_2$ , &c. as being subject to the necessary conditions (4) shall further render the function

$$2\Omega = x_1^2 + y_1^2 + (x_1 + y_1 + \epsilon_1)^2 + x_2^2 + y_2^2 + (x_2 + y_2 + \epsilon_2)^2 + \dots$$

a minimum. Differentiating this equation, the condition of minimum is

$$\begin{aligned} 0 &= \frac{d\Omega}{dx_1} dx_1 + \frac{d\Omega}{dy_1} dy_1 + \frac{d\Omega}{dx_2} dx_2 + \frac{d\Omega}{dy_2} dy_2 + \dots \\ &= (2x_1 + y_1 + \epsilon_1) dx_1 + (x_1 + 2y_1 + \epsilon_1) dy_1 \\ &\quad + (2x_2 + y_2 + \epsilon_2) dx_2 \dots \end{aligned}$$

Differentiate the equations (4), and having multiplied them by multipliers  $3Q$  and  $3P$  respectively, let them be added to the equation just written down, and we have

$$\begin{aligned} 0 &= (2x_1 + y_1 + \epsilon_1 - 3\alpha_1 P + 3Q) dx_1, \\ &+ (x_1 + 2y_1 + \epsilon_1 + 3\beta_1 P + 3Q) dy_1, \\ &+ (2x_2 + y_2 + \epsilon_2 - 3\alpha_2 P + 3Q) dx_2, \\ &+ (x_2 + 2y_2 + \epsilon_2 + 3\beta_2 P + 3Q) dy_2, \\ &+ \dots \end{aligned}$$

Now according to the principles of the differential calculus the coefficients of  $dx_1, dy_1, \dots dx_i, dy_i$  must be severally equal



to zero. Hence we are led to these equations:

$$\begin{aligned} x_1 &= -\frac{1}{3} \epsilon_1 + a_1 P - Q, & x_2 &= -\frac{1}{3} \epsilon_2 + a_2 P - Q, & (5) \\ y_1 &= -\frac{1}{3} \epsilon_1 + b_1 P - Q, & y_2 &= -\frac{1}{3} \epsilon_2 + b_2 P - Q, \\ z_1 &= -\frac{1}{3} \epsilon_1 + c_1 P + 2Q, & z_2 &= -\frac{1}{3} \epsilon_2 + c_2 P + 2Q, \end{aligned}$$

and so for the other triangles. Now by substituting the values of  $x_1 y_1, x_2 y_2, \&c.$  so expressed in the equations (4), we get two others from which  $P$  and  $Q$  can be eliminated. If we put

$$\begin{aligned} h &= c_1 + c_2 + \dots c_i, \\ k &= a_1^2 + a_1 \beta_1 + \beta_1^2 + a_2^2 + a_2 \beta_2 + \beta_2^2 + \dots a_i^2 + a_i \beta_i + \beta_i^2, \\ M &= -\epsilon_0 + \frac{1}{3} (\epsilon_1 + \epsilon_2 + \dots \epsilon_i), \\ N &= \epsilon - \frac{1}{3} (\epsilon_1 c_1 + \epsilon_2 c_2 + \dots \epsilon_i c_i), \end{aligned}$$

then

$$\begin{aligned} hP + 2iQ &= M, \\ 2kP + hQ &= N; \end{aligned}$$

and consequently, if further we put  $4ik - h^2 = U,$

$$\begin{aligned} UP &= -hM + 2iN, & (6) \\ UQ &= +2kM - hN, \end{aligned}$$

which fully determine  $P$  and  $Q$ : and the values of  $x_1 y_1 z_1, x_2 y_2 z_2, x_i y_i z_i$  follow at once from equations (5). This completely solves the question: the finally adopted values of the angles are, for instance in triangle 1:

$$\begin{aligned} \mathfrak{A}_1 &= A_1 + \frac{1}{3} (2e_1 - f_1 - g_1) + a_1 P - Q, & (7) \\ \mathfrak{B}_1 &= B_1 + \frac{1}{3} (-e_1 + 2f_1 - g_1) + b_1 P - Q, \\ \mathfrak{C}_1 &= C_1 + \frac{1}{3} (-e_1 - f_1 + 2g_1) + c_1 P + 2Q. \end{aligned}$$

## 2.

We shall now ascertain how these adopted angles are individually affected by the actual errors of the observed angles. If we substitute in (5) the values of  $M$  and  $N$ , after replacing  $\epsilon \epsilon_0 \epsilon_1 \epsilon_2 \dots \epsilon_i$  by their equivalents in terms of the actual errors of observation from (1) and (3) we get

$$\begin{aligned} UP &= E_1 e_1 + F_1 f_1 + G_1 g_1 + E_2 e_2 + F_2 f_2 + G_2 g_2 + \dots, \\ UQ &= E_1' e_1 + F_1' f_1 + G_1' g_1 + E_2' e_2' + F_2' f_2' + G_2' g_2' + \dots, \end{aligned}$$

where

$$\begin{aligned} 3 E_n &= -h - 2i a_n, & 3 E'_n &= 2k + a_n h, \\ 3 F_n &= -h - 2i b_n, & 3 F'_n &= 2k + b_n h, \\ 3 G_n &= 2h - 2i c_n, & 3 G'_n &= -4k + c_n h. \end{aligned}$$

Among these quantities we shall require for the investigation of probable errors the following relations which are easily verified :

$$\begin{aligned} \Sigma (E^2 + F^2 + G^2) &= \frac{2}{3} i U, \\ \Sigma (E'^2 + F'^2 + G'^2) &= \frac{2}{3} k U, \\ \Sigma (EE' + FF' + GG') &= -\frac{1}{3} U. \end{aligned}$$

The substitution of the last expressions for  $P$  and  $Q$  in the equations (7) leads to the following :

$$\begin{aligned} \mathfrak{A}_1 &= A_1 + \epsilon_1 e_1 + \mathfrak{f}_1 f_1 + \mathfrak{g}_1 g_1 + \epsilon_2 e_2 + \mathfrak{f}_2 f_2 + \mathfrak{g}_2 g_2 + \dots, \\ \mathfrak{B}_1 &= B_1 + \epsilon'_1 e_1 + \mathfrak{f}'_1 f_1 + \mathfrak{g}'_1 g_1 + \epsilon'_2 e_2 + \mathfrak{f}'_2 f_2 + \mathfrak{g}'_2 g_2 + \dots, \\ \mathfrak{C}_1 &= C_1 + \epsilon''_1 e_1 + \mathfrak{f}''_1 f_1 + \mathfrak{g}''_1 g_1 + \epsilon''_2 e_2 + \mathfrak{f}''_2 f_2 + \mathfrak{g}''_2 g_2 + \dots, \end{aligned}$$

where

$$\begin{aligned} \epsilon_1 &= \frac{2}{3} + \frac{1}{U} (a_1 E_1 - E'_1), & \epsilon_2 &= \frac{1}{U} (a_1 E_2 - E'_2) \dots, \\ \mathfrak{f}_1 &= -\frac{1}{3} + \frac{1}{U} (a_1 F_1 - F'_1), & \mathfrak{f}_2 &= \frac{1}{U} (a_1 F_2 - F'_2) \dots, \\ \mathfrak{g}_1 &= -\frac{1}{3} + \frac{1}{U} (a_1 G_1 - G'_1), & \mathfrak{g}_2 &= \frac{1}{U} (a_1 G_2 - G'_2) \dots; \\ \epsilon'_1 &= -\frac{1}{3} + \frac{1}{U} (b_1 E_1 - E'_1), & \epsilon'_2 &= \frac{1}{U} (b_1 E_2 - E'_2) \dots, \\ \mathfrak{f}'_1 &= \frac{2}{3} + \frac{1}{U} (b_1 F_1 - F'_1), & \mathfrak{f}'_2 &= \frac{1}{U} (b_1 F_2 - F'_2) \dots, \\ \mathfrak{g}'_1 &= -\frac{1}{3} + \frac{1}{U} (b_1 G_1 - G'_1), & \mathfrak{g}'_2 &= \frac{1}{U} (b_1 G_2 - G'_2) \dots; \\ \epsilon''_1 &= -\frac{1}{3} + \frac{1}{U} (c_1 E_1 + 2 E'_1), & \epsilon''_2 &= \frac{1}{U} (c_1 E_2 + 2 E'_2) \dots, \\ \mathfrak{f}''_1 &= -\frac{1}{3} + \frac{1}{U} (c_1 F_1 + 2 F'_1), & \mathfrak{f}''_2 &= \frac{1}{U} (c_1 F_2 + 2 F'_2) \dots, \\ \mathfrak{g}''_1 &= \frac{2}{3} + \frac{1}{U} (c_1 G_1 + 2 G'_1), & \mathfrak{g}''_2 &= \frac{1}{U} (c_1 G_2 + 2 G'_2) \dots; \end{aligned}$$

Put now  $S, S', S''$  for the sum of the squares of the above

coefficients of the actual errors in the expression for the adopted angles, then after a little reduction, we get, on putting  $\epsilon$  for the probable error of an observed angle, the following probable errors of the adopted angles—for

$$\begin{aligned} \mathfrak{A}_1 \dots \pm \epsilon \sqrt{S} &= \pm \epsilon \sqrt{\left\{ \frac{2}{3} - \frac{1}{6i} - \frac{3}{2} \frac{E_1^2}{iU} \right\}}, & (8) \\ \mathfrak{B}_1 \dots \pm \epsilon \sqrt{S'} &= \pm \epsilon \sqrt{\left\{ \frac{2}{3} - \frac{1}{6i} - \frac{3}{2} \frac{F_1^2}{iU} \right\}}, \\ \mathfrak{C}_1 \dots \pm \epsilon \sqrt{S''} &= \pm \epsilon \sqrt{\left\{ \frac{2}{3} - \frac{2}{3i} - \frac{3}{2} \frac{G_1^2}{iU} \right\}}. \end{aligned}$$

For the probable errors of the corrections  $x_1 y_1 z_1$ , to the observed angles we should obtain the following—for

$$\begin{aligned} x_1 \dots \pm \epsilon \sqrt{\left\{ \frac{1}{3} + \frac{1}{6i} + \frac{3}{2} \frac{E_1^2}{iU} \right\}}, & (9) \\ y_1 \dots \pm \epsilon \sqrt{\left\{ \frac{1}{3} + \frac{1}{6i} + \frac{3}{2} \frac{F_1^2}{iU} \right\}}, \\ z_1 \dots \pm \epsilon \sqrt{\left\{ \frac{1}{3} + \frac{2}{3i} + \frac{3}{2} \frac{G_1^2}{iU} \right\}}. \end{aligned}$$

### 3.

As a numerical example of the application of these formulae we shall take a very large polygon which embraces the greater part of Ireland. The central point is Keeper ( $P$ ) in the county of Tipperary; then in succession Baurtregaum ( $P_1$ ) near Tralee; Bencorr ( $P_2$ ) in Connemara; Nephin ( $P_3$ ) in Mayo; Cuilcagh ( $P_4$ ) near Enniskillen; Kippure ( $P_5$ ) near Dublin; and Knockanaffrin ( $P_6$ ) in Waterford. In taking this piece of work as an example it is necessary to remark that the conditions are not such as are supposed in our preceding investigations: the angles are not observed independently, and they are not of equal weight. The angles were observed as explained at page 181, consequently the sum of the angles at  $P$  is necessarily  $360^\circ$ : hence  $\epsilon_0 = 0$ . Nevertheless, with this proviso the polygon will serve our purpose of illustration. The following table contains the

data for the solution, and from these we have to calculate the 18 corrections to the observed angles:—

$\Delta$	OBSERVED ANGLES.	ERROR OF $\Delta$	$a, b, c, \epsilon c.$	$a^2 + b^2 + c^2$
$PP_1P_2$	$A_1' = \overset{\circ}{58} \overset{'}{46} \overset{''}{5.46}$ $B_1' = 52 \ 16 \ 22.32$ $C_1' = 68 \ 58 \ 8.90$ Sum ... .. = 36.68 Sph. excess = 38.36	$\epsilon_1 = -1.68$	$a_1 = + 1.986$ $b_1 = - 2.154$ $c_1 = + 0.168$ $\epsilon_1 c_1 = - 0.282$	8.612
$PP_2P_3$	$A_2' = 102 \ 34 \ 5.26$ $B_2' = 54 \ 38 \ 27.77$ $C_2' = 22 \ 47 \ 43.81$ Sum ... .. = 16.84 Sph. excess = 20.63	$\epsilon_2 = -3.76$	$a_2 = + 0.264$ $b_2 = - 1.197$ $c_2 = + 0.933$ $\epsilon_2 c_2 = - 3.508$	2.373
$PP_3P_4$	$A_3' = 74 \ 5 \ 54.27$ $B_3' = 68 \ 22 \ 0.37$ $C_3' = 37 \ 32 \ 47.29$ Sum ... .. = 41.93 Sph. excess = 40.12	$\epsilon_3 = +1.81$	$a_3 = + 0.967$ $b_3 = - 1.079$ $c_3 = + 0.112$ $\epsilon_3 c_3 = + 0.203$	2.112
$PP_4P_5$	$A_4' = 51 \ 55 \ 12.30$ $B_4' = 69 \ 17 \ 33.41$ $C_4' = 58 \ 48 \ 2.80$ Sum ... .. = 48.51 Sph. excess = 49.03	$\epsilon_4 = -0.52$	$a_4 = + 1.946$ $b_4 = - 1.540$ $c_4 = - 0.406$ $\epsilon_4 c_4 = + 0.211$	6.323
$PP_5P_6$	$A_5' = 29 \ 40 \ 42.02$ $B_5' = 81 \ 34 \ 25.36$ $C_5' = 68 \ 4; \ 22.28$ Sum ... .. = 29.66 Sph. excess = 22.50	$\epsilon_5 = +7.16$	$a_5 = + 3.658$ $b_5 = - 2.051$ $c_5 = - 1.607$ $\epsilon_5 c_5 = - 11.506$	20.170
$PP_6P_1$	$A_6' = 50 \ 55 \ 6.36$ $B_6' = 25 \ 57 \ 17.09$ $C_6' = 103 \ 7 \ 54.92$ Sum ... .. = 18.37 Sph. excess = 20.88	$\epsilon_6 = -2.51$	$a_6 = + 3.678$ $b_6 = - 4.920$ $c_6 = + 1.242$ $\epsilon_6 c_6 = - 3.117$	39.277

In the equations (1), (2), (3), and (4) we must suppose the unit to be one second of angle. Suppose that the result of the calculation is that

$$\log \frac{\sin B_1' \sin B_2' \dots \sin B_i'}{\sin A_1' \sin A_2' \dots \sin A_i'} = \eta,$$

where  $\eta$  is a very small quantity, then  $\eta = \log(1 + \epsilon \sin 1'')$ ,

and 
$$\epsilon = \frac{\eta}{\text{mod. } \sin 1''}.$$

The calculation stands thus:

log sin $B'$ .	log sin $A'$ .
9.8981401,4	9.9320049,5
9.9114466,6	9.9894667
9.9682787,3	9.9830548,6
9.9709966,3	9.8960582
9.9952864	9.6947194,7
9.6411380	9.8900012
sum = 9.3852865,6	9.3853053,8 = sum;
$\eta = -.0000188,2$	$\epsilon = -8''.93;$
$h = \Sigma(c)$	= + 0.442,
$k = \frac{1}{8} \Sigma(a_1^2 + b_1^2 + c_1^2)$	= + 13.144,
$M = \frac{1}{8} \Sigma(\epsilon_1)$	= + 0.167,
$N = \epsilon - \frac{1}{8} \Sigma(\epsilon_1 c_1)$	= - 2.930,
$U = 24k - h^2$	= 315.273;
$UP = -35.234,$	$P = -0.11176,$
$UQ = + 5.677,$	$Q = + 0.01800.$

The values of  $x_1 y_1 z_1 \dots x_6 y_6 z_6$  immediately follow from equations (5), they are as follows:

ANGLES.	$PP_1 P_2$	$PP_2 P_3$	$PP_3 P_4$	$PP_4 P_5$	$PP_5 P_6$	$PP_6 P_1$
$A'$	$x_1 = + 0.32$	$+ 1.21$	$- 0.73$	$- 0.06$	$- 2.81$	$+ 0.41$
$B'$	$y_1 = + 0.78$	$+ 1.37$	$- 0.50$	$+ 0.33$	$- 2.18$	$+ 1.37$
$C'$	$z_1 = + 0.58$	$+ 1.18$	$- 0.58$	$+ 0.25$	$- 2.17$	$+ 0.73$

If now we apply these corrections to the observed angles, each triangle will close correctly, and the reproduction of the side  $PP_1$  by calculation through the angles of the polygon will stand thus:

log sin $\mathfrak{B}$ .	log sin $\mathfrak{A}$ .
9.8981414,6	9.9320053,4
9.9114487	9.9894661,7
9.9682783	9.9830544
9.9709969	9.8960580,8
9.9952856,6	9.6947090,6
9.6411438,7	9.8900019
sum = 9.3852949	9.3852949,5 = sum.

The probable errors of the adopted angles  $\mathfrak{A}$ ,  $\mathfrak{B}$ ,  $\mathfrak{C}$  are for the first triangle

$$\pm 0''.766 \epsilon, \quad \pm 0''.762 \epsilon, \quad \pm 0''.746 \epsilon,$$

and similarly for the others. Here  $\epsilon$  is the probable error of an observed angle expressed in seconds.

3.

Let the adjoining figure represent a chain of triangles,  $F_1, F_2, \dots, F_i$  being the points in which perpendiculars from the trigonometrical stations  $P_1, P_2, \dots$  meet the meridian through  $P$ : let the length of the side

$$P_n P_{n+1} = k_n,$$

and the angle the direction  $P_n P_{n+1}$  makes with the north meridian  $K_n$ . Suppose in the first place that each angle of each triangle is equally well observed, the probable error of an observed angle being  $\pm \epsilon$ .

Then the last side of the chain is  $k_i =$

$$k_0 \frac{\sin B_1 \sin B_2 \dots \sin B_i}{\sin A_1 \sin A_2 \dots \sin A_i}.$$

If this be calculated by using the observed angles  $A'_1, B'_1, \dots$  the result  $k'_i$  will be

$$k'_i = k_0 \frac{\sin B'_1 \sin B'_2 \dots \sin B'_i}{\sin A'_1 \sin A'_2 \dots \sin A'_i}.$$

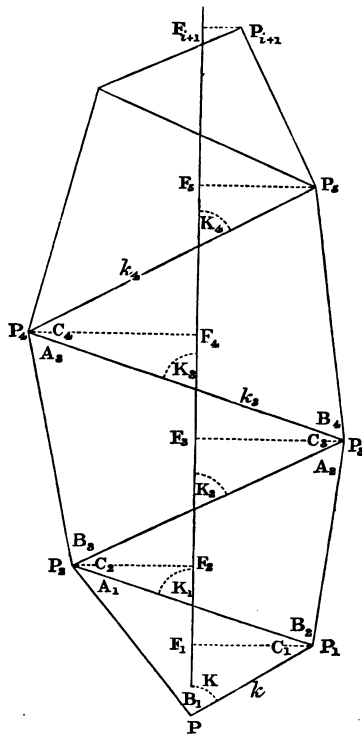

Fig. 47.

Using the same notation as before, and putting  $k'_i - k_i = \epsilon k_i$ , we have

$$\epsilon = -\alpha_1 e_1 + \beta_1 f_1 - \alpha_2 e_2 + \beta_2 f_2 - \dots$$

But if we correct each observed angle in each triangle by applying to it with a negative sign the third part of the excess of the sum of the observed angles above the truth, then the corrected angles are—in the first triangle,

$$\begin{aligned} \mathfrak{A}_1 &= A_1 + \frac{2}{3} e_1 - \frac{1}{3} f_1 - \frac{1}{3} g_1, \\ \mathfrak{B}_1 &= B_1 - \frac{1}{3} e_1 + \frac{2}{3} f_1 - \frac{1}{3} g_1, \\ \mathfrak{C}_1 &= C_1 - \frac{1}{3} e_1 - \frac{1}{3} f_1 + \frac{2}{3} g_1, \end{aligned} \quad (10)$$

and so for the others.

If we calculate  $k_i$  with these corrected angles and put still  $k'_i - k_i = \epsilon k_i$ , we have

$$-\epsilon = \frac{1}{3} e_1 a_1 + \frac{1}{3} f_1 b_1 + \frac{1}{3} g_1 c_1 + \frac{1}{3} e_2 a_2 + \frac{1}{3} f_2 b_2 + \frac{1}{3} g_2 c_2 + \dots,$$

which expresses the error of the resulting length of  $P_i P_{i+1}$  in terms of the actual errors of the observed angles. The probable error of  $k'_i$  is thus

$$\pm \frac{1}{3} \epsilon k_i \sqrt{\Sigma(a^2 + b^2 + c^2)} = \pm \epsilon k_i \sqrt{\frac{2}{3} \Sigma(a^2 + a\beta + \beta^2)}. \quad (11)$$

The reciprocal of  $\epsilon^2(a^2 + a\beta + \beta^2)$  for any triangle or the reciprocal of the mean value of  $\epsilon^2 \Sigma(a^2 + a\beta + \beta^2)$  for a chain of triangles is called by Struve the 'weight of continuation' of the triangle or of the series. It is greatest when  $A$  and  $B$  are nearly right angles, but in this case the angle  $C$  is very small and the triangle makes little 'progress' in the chain. Hence the weight of a triangle is proportional to the progress it makes multiplied by the weight of continuation.

Consider now the error of the calculated direction  $K'_i$  of the last side  $k_i$  of the chain.

Between  $K_n$ ,  $C_{n+1}$ , and  $K_{n+1}$  there exists the relation

$$K_n + K_{n+1} + C_{n+1} = \pi,$$

whence it follows that

$$\begin{aligned} K_1 &= \pi - C_1 - K, \\ K_2 &= C_1 - C_2 + K, \\ K_3 &= \pi - C_1 + C_2 - C_3 - K, \\ K_4 &= C_1 - C_2 + C_3 - C_4 + K, \end{aligned}$$

the law of which is obvious. Hence the azimuth of the last

side as obtained from the corrected angles is

$$\mathcal{C}_1 - \mathcal{C}_2 + \mathcal{C}_3 - \dots + K, \text{ or } \pi - \mathcal{C}_1 + \mathcal{C}_2 - \mathcal{C}_3 + \dots - K,$$

according as  $i$  is even or odd. Thus the error of the calculated direction of  $k_i$  is, disregarding its sign, and considering  $K$  as free from error,

$$\frac{1}{3} e_1 + \frac{1}{3} f_1 - \frac{2}{3} g_1 - \frac{1}{3} e_2 - \frac{1}{3} f_2 + \frac{2}{3} g_2 + \frac{1}{3} e_3 \dots,$$

and the corresponding probable error

$$\pm \epsilon \sqrt{\frac{2i}{3}}.$$

Using the accent still to denote calculated quantities, the calculated value of  $PF_{i+1}$  is

$$k_0 \cos K + k_1' \cos K_1' + k_2' \cos K_2' + k_3' \cos K_3' + \dots k_i' \cos K_i',$$

and in order to determine the probable error of this result it is necessary to express each term as a linear function of  $e_1 f_1 g_1, e_2 f_2 g_2, \dots$  and then to ascertain the sum of the squares of the coefficients of those symbols.

In thus estimating the errors of the calculated length of the chain and of the azimuth of the last side, we have treated the triangles as plane triangles, a simplification which can lead to no incorrect result.

#### 4.

Suppose that both the sides  $k_0$  and  $k_i$  are measured lines, free from error, and that it is required to correct the observed angles of the intervening chain so as to bring them into harmony with these lengths. Then when we use the thus corrected angles to calculate  $k_i$  from  $k$  we arrive at a true result: thus

$$\frac{\sin B_1 \sin B_2 \dots \sin B_i}{\sin A_1 \sin A_2 \dots \sin A_i} = \frac{\sin \mathfrak{B}_1 \sin \mathfrak{B}_2 \dots \sin \mathfrak{B}_i}{\sin \mathfrak{A}_1 \sin \mathfrak{A}_2 \dots \sin \mathfrak{A}_i},$$

or

$$0 = -a_1(e_1 + x_1) + \beta_1(f_1 + y_1) - \dots - a_i(e_i + x_i) + \beta_i(f_i + y_i).$$

Suppose that first  $k_i$  is calculated by means of the observed angles  $A_1', B_1', A_2', B_2', \dots$ , and  $k_i'$  being the result, let  $k_i' - k_i = \epsilon k_i$ , then

$$\epsilon = -a_1 e_1 + \beta_1 f_1 - a_2 e_2 + \beta_2 f_2 \dots - a_i e_i + \beta_i f_i;$$



also using the same notation as before

$$e_n + f_n + g_n = \epsilon_n, \quad x_n + y_n + z_n = -\epsilon_n,$$

and

$$-\epsilon = -\alpha_1 x_1 + \beta_1 y_1 - \alpha_2 x_2 + \beta_2 y_2 - \dots - \alpha_i x_i + \beta_i y_i. \quad (12)$$

Further, let us take the more general case in which the angles are not equally well observed, and let the weights of  $A'_n, B'_n, C'_n$  be the reciprocals of  $w_n, w'_n, w''_n$ . Then the most probable values of  $x_1, y_1, z_1, x_2, y_2, z_2$  are those, which, subject to the condition (12), render a minimum,

$$2\Omega = \frac{x_1^2}{w_1} + \frac{y_1^2}{w'_1} + \frac{(x_1 + y_1 + \epsilon_1)^2}{w_1''} + \frac{x_2^2}{w_2} + \frac{y_2^2}{w'_2} + \frac{(x_2 + y_2 + \epsilon_2)^2}{w_2''} + \dots$$

To the differential of  $\Omega$  add the differential of the right hand member of (12) multiplied by  $3Q$ ; then make the coefficients of  $dx_1, dy_1, dx_2, dy_2, \dots$  severally zero. The first two give

$$\begin{aligned} \frac{x_1}{w_1} + \frac{x_1 + y_1 + \epsilon_1}{w_1''} - 3\alpha_1 Q &= 0, \\ \frac{y_1}{w'_1} + \frac{x_1 + y_1 + \epsilon_1}{w_1''} + 3\beta_1 Q &= 0; \end{aligned}$$

whence we have

$$\begin{aligned} x_1 &= \frac{-\epsilon_1 w_1}{w_1 + w'_1 + w_1''} + 3w_1 Q \frac{(a_1 + \beta_1)w_1' + a_1 w_1''}{w_1 + w'_1 + w_1''}, \quad (13) \\ y_1 &= \frac{-\epsilon_1 w_1'}{w_1 + w'_1 + w_1''} - 3w_1' Q \frac{(a_1 + \beta_1)w_1 + \beta_1 w_1''}{w_1 + w'_1 + w_1''}, \\ z_1 &= \frac{-\epsilon_1 w_1''}{w_1 + w'_1 + w_1''} + 3w_1'' Q \frac{\beta_1 w_1' - a_1 w_1}{w_1 + w'_1 + w_1''}; \end{aligned}$$

the sum  $x_1 + y_1 + z_1$  making up  $-\epsilon_1$ . Now if we substitute in (12) the values thus obtained of the  $x$ 's and  $y$ 's the resulting equation will give  $Q$  in terms of known quantities, and thus all the required corrections to the angles follow from (13) and similar equations for each triangle. This completely solves the problem.  $Q$  being expressed in terms of  $\epsilon, \epsilon_1, \epsilon_2, \dots$  these may be replaced by their equivalent expressions in terms of the  $3i$  actual errors of observed angles, and thus, finally, the adopted angles and the length and

direction of any side may be expressed in terms of the 3i errors.

To avoid complexity, suppose the weights of all the observed angles equal, thus

$$\begin{aligned} x_1 &= -\frac{1}{3} \epsilon_1 + a_1 Q, & x_2 &= -\frac{1}{3} \epsilon_2 + a_2 Q \dots, \\ y_1 &= -\frac{1}{3} \epsilon_1 + b_1 Q, & y_2 &= -\frac{1}{3} \epsilon_2 + b_2 Q \dots, \\ z_1 &= -\frac{1}{3} \epsilon_1 + c_1 Q, & z_2 &= -\frac{1}{3} \epsilon_2 + c_2 Q \dots; \end{aligned}$$

substituting in (12) and putting  $\Sigma (a^2 + b^2 + c^2) = 6k$  as at page 220, we have

$$-6kQ = a_1 e_1 + b_1 f_1 + c_1 g_1 + a_2 e_2 + b_2 f_2 + c_2 g_2 + \dots.$$

Thus we find for the actual errors of the adopted angles in the first triangle the expressions

$$\begin{aligned} \frac{e_1}{3} \left( 2 - \frac{a_1 a_1}{2k} \right) + \frac{f_1}{3} \left( -1 - \frac{a_1 b_1}{2k} \right) + \frac{g_1}{3} \left( -1 - \frac{a_1 c_1}{2k} \right) \\ - \frac{a_1}{6k} (e_2 a_2 + f_2 b_2 + g_2 c_2) - \dots, \\ \frac{e_1}{3} \left( -1 - \frac{b_1 a_1}{2k} \right) + \frac{f_1}{3} \left( 2 - \frac{b_1 b_1}{2k} \right) + \frac{g_1}{3} \left( -1 - \frac{b_1 c_1}{2k} \right) \\ - \frac{b_1}{6k} (e_2 a_2 + f_2 b_2 + g_2 c_2) - \dots, \\ \frac{e_1}{3} \left( -1 - \frac{c_1 a_1}{2k} \right) + \frac{f_1}{3} \left( -1 - \frac{c_1 b_1}{2k} \right) + \frac{g_1}{3} \left( 2 - \frac{c_1 c_1}{2k} \right) \\ - \frac{c_1}{6k} (e_2 a_2 + f_2 b_2 + g_2 c_2) - \dots; \end{aligned}$$

and by taking the sum of the squares of the coefficients of  $e_1, f_1, g_1$ , &c. we get for the probable errors of the adopted angles:

$$\begin{aligned} \text{Probable error of } \mathfrak{A}_n \dots &\pm \epsilon \sqrt{\left( \frac{2}{3} - \frac{a_n^2}{6k} \right)}, \\ \text{,, ,, } \mathfrak{B}_n \dots &\pm \epsilon \sqrt{\left( \frac{2}{3} - \frac{b_n^2}{6k} \right)}, \\ \text{,, ,, } \mathfrak{C}_n \dots &\pm \epsilon \sqrt{\left( \frac{2}{3} - \frac{c_n^2}{6k} \right)}. \end{aligned}$$

The error of the direction of the side  $k_i$  (that of the first side being free from error) depends on  $\mathfrak{C}_1 - \mathfrak{C}_2 + \mathfrak{C}_3 - \dots$ : the expression for the error is

$$z_1 + g_1 - z_2 - g_2 + z_3 + g_3 - z_4 + \dots;$$

and if we add the sum of the squares of the coefficients as before, we find for the probable error of the direction in question,

$$\pm \epsilon \sqrt{\left(\frac{2i}{3} - \frac{2}{3}kC^2\right)},$$

where

$$2kC = c_1 - c_2 + c_3 - c_4 \dots$$

### 5.

The probable error  $\epsilon$  of an observed angle must depend not only on the excellence of the instrument employed, the expertness of the observer, and the number of observations taken; but also on the care and skill with which the operations generally are conducted. In as far as it depends on errors of bisection, of reading the circle, and of graduation, a value of  $\epsilon$  may be obtained from the internal evidence of the observations themselves at any station by comparing individual measures of an angle with their mean. But the observed angles are affected with other errors which are only brought out in combining the observations made at different stations. For instance, if there be any residual error of centering the instrument over the station-mark, or if a signal observed be not truly centred on the station-mark, a constant error will result. In some instances local configuration of the surface may give rise to a lateral refraction, doubtless very small in amount, but persistent. Again a signal in the direction of east or west is liable to be differently illuminated on the north side and on the south so as to present a phase: any signal which is habitually seen in some peculiar light may present a phase.

A more trustworthy method therefore than the evidence of the observations themselves is presented by the errors in the sums of the observed angles of triangles. In the 107 triangles between Dunkirk and Formentera the mean square of error of a triangle is 4.161, hence the mean square of error of an observed angle is one third of this or 1.387: the probable error of an observed angle therefore in this work is

$$\pm .6745 \sqrt{1.387} = \pm 0''.794.$$

In Colonel Everest's chain of triangles between the Dehra Dun and Seronj bases the 86 triangle errors give  $\epsilon = \pm 0''.517$ ; and for his 72 triangles between the Beder base and the Seronj base  $\epsilon = \pm 0''.370$ . In the Russian arc, the probable error of an observed angle in the Baltic provinces is

$$\epsilon = \pm 0''.387;$$

in Bessarabia  $\epsilon = \pm 0''.573$ ; in Finland  $\epsilon = \pm 0''.589$ ; in Lapland  $\epsilon = \pm 0''.843$ , while in the 12 extreme northern triangles  $\epsilon = \pm 1''.466$ .

## 6.

The chain of triangles joining Dunkirk and Formentera is a simple chain such as we have been considering. The same may be said of the greater part of the Russian chain, though in the portion of the work north of Tornea as far as Fuglenaes the work is strengthened by the observation of a greater number of points at each station. The accompanying diagram shows a portion of the meridional chain of Madrid starting from the base of Madrideojos. It is clear that such chains cannot be dealt with in the same manner as the simple chain of triangles we have been considering, and this remark applies still more forcibly to triangulations like that of Great Britain and Ireland where the lines of observation are interlaced in every possible manner.

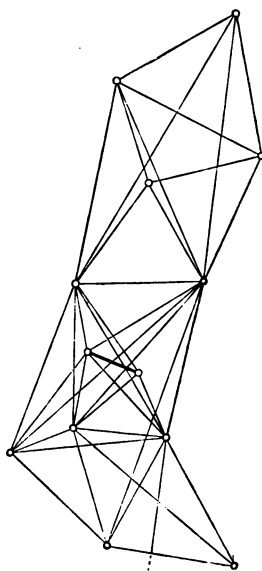

Fig. 48.

The equations of condition of a triangulation are those which exist between the supernumerary observed quantities and their calculated values: that is to say, after there are just sufficient observations to fix all the points, then any angle subsequently observed can be compared with

its calculated value. If a triangulation consist of  $n + 2$  points, two of which are the extremities of a base line, then the remaining  $n$  points will require  $2n$  observed angles for their fixation, so that if  $m$  be the number of observed angles there will be  $m - 2n$  equations of condition. The manner of obtaining these is as follows. Suppose a number of points  $A, B, C, \dots$  already fixed, and that a new point  $P$  is observed from and observes back  $m$  of these points, then there will be formed  $m - 1$  triangles, in each of which the sum of the observed angles must be equal to  $180^\circ$  plus the spherical excess; this gives at once  $m - 1$  equations of condition. The  $m - 2$  distances will each afford an equation of the form called a side equation, viz. :

$$\frac{PC}{PB} \cdot \frac{PB}{PA} \cdot \frac{PA}{PC} = 1,$$

not however limited to three factors. Should  $P$  observe and be observed from only two points then there will be but one equation of condition; when  $m$  is not less than 2 every other bearing not reciprocal whether from  $P$  to the fixed points or from the fixed points to  $P$  will give a side equation. When independent angles are observed another species of equation enters arising from the consideration that at every point where all the angles round the horizon have been observed, their sum must  $= 360^\circ$ . In what follows this case is not supposed.

If then there be  $M$  observed bearings at  $N$  stations there will be  $M - N$  angles for fixing  $N - 2$  points, which require only  $2N - 4$  angles, so that the number of equations of condition is  $M - 3N + 4$ . If further there be  $P$  points at which there are no angles observed the number of equations of condition will be  $M - 3N - 2P + 4$ , where  $N$  is the number of observing stations. To these must be added equations which may arise from there being more than one measured base; thus  $n$  bases would give rise to  $n - 1$  side equations.

The side equations take the form

$$1 = \frac{\sin(B_1' + y_1) \sin(B_2' + y_2) \sin(B_3' + y_3) \dots}{\sin(A_1' + x_1) \sin(A_2' + x_2) \sin(A_3' + x_3) \dots}, \quad (14)$$

where  $x_1 y_1, x_2 y_2, \dots$  are corrections to the observed angles

$A_1' B_1', A_2' B_2', \dots$ . This may be written

$$-x_1 \cot A_1' + y_1 \cot B_1 - x_2 \cot A_2 + \dots = -1 + \frac{\sin A_1' \sin A_2' \dots}{\sin B_1' \sin B_2' \dots}$$

Let  $x_1 y_1, \dots$  be expressed in seconds, and take the logarithm of (14); then if we put

$$\text{mod. sin } 1'' \cot A_1' = a_1, \quad \text{mod. sin } 1'' \cot B_1' = b_1,$$

and so on, we shall have

$$0 = \Sigma (\log \sin B' - \log \sin A') - a_1 x_1 + b_1 y_1 - a_2 x_2 + b_2 y_2 \dots \quad (15)$$

Here  $a_1 b_1, \dots$  are the differences of the logarithmic sines for one second.

Thus we see how to obtain in any given triangulation all the necessary conditions that exist among the observed angles and to express them in the form of linear equations among the corrections to be applied to these angles. The corrections are as yet indeterminate; but according to the theory of probabilities the most probable values are those that render a minimum the sum of the squares of all the errors of observation.

7.

Consider first the angles observed at one station only. Selecting one signal,  $R$  say, from amongst those observed, as that to which the direction of all the others are to be referred; let the directions of the other signals taken in azimuthal order make with the direction of  $R$  the angles  $A, B, C, \dots$ , these being the most probable values to be determined. Let the first arc give the readings  $m_1, m_1', m_1'', m_1''', \dots, m_1$  corresponding to the arbitrary reading of  $R$ , of which let  $x_1$  be the true or most probable value: then the first, second, and third arcs will give the equations

$$\begin{aligned} m_1 - x_1 &= 0, & m_1' - x_1 - A &= 0, & m_1'' - x_1 - B &= 0, \\ m_2 - x_2 &= 0, & m_2' - x_2 - A &= 0, & m_2'' - x_2 - B &= 0, \\ m_3 - x_3 &= 0, & m_3' - x_3 - A &= 0, & m_3'' - x_3 - B &= 0, \end{aligned}$$

and so on. These equations at least would hold good were the observations free from error; as it is, the left hand members are the errors of observation, the sum of the squares of which must be made a minimum in order to obtain the

most probable values of  $A, B, C, \dots$  and of the arbitrary distances  $x_1, x_2, x_3, \dots$  of the zero of the circle from the signal of reference. In order to make the result general, multiply these equations by multipliers

$$\sqrt{p_1}, \sqrt{p_1'}, \sqrt{p_1''} \dots \sqrt{p_2}, \sqrt{p_2'}, \sqrt{p_2''},$$

each of these to be unity when there is an observation, or zero when the corresponding observation is wanting. Then the sum of the squares of all the errors of observation at this station is

$$\begin{aligned} & p_1(m_1 - x_1)^2 + p_1'(m_1' - x_1 - A)^2 + p_1''(m_1'' - x_1 - B)^2 + \dots, \\ & + p_2(m_2 - x_2)^2 + p_2'(m_2' - x_2 - A)^2 + p_2''(m_2'' - x_2 - B)^2 + \dots, \\ & + p_3(m_3 - x_3)^2 + p_3'(m_3' - x_3 - A)^2 + p_3''(m_3'' - x_3 - B)^2 + \dots, \\ & \quad \&c. \end{aligned}$$

The differential coefficients of this sum with respect to  $x_1, x_2, x_3 \dots A, B, C, \dots$  being severally equated to zero, we have these equations:

$$\begin{aligned} p_1 m_1 + p_1' m_1' + \dots &= (p_1 + p_1' + \dots) x_1 + p_1' A + p_1'' B + \dots, \\ p_2 m_2 + p_2' m_2' + \dots &= (p_2 + p_2' + \dots) x_2 + p_2' A + p_2'' B + \dots, \\ p_3 m_3 + p_3' m_3' + \dots &= (p_3 + p_3' + \dots) x_3 + p_3' A + p_3'' B + \dots, \\ & \quad \&c.; \end{aligned}$$

$$\begin{aligned} p_1' m_1' + p_2' m_2' + \dots &= (p_1' + p_2' + \dots) A + p_1' x_1 + p_2' x_2 \dots, \\ p_1'' m_1'' + p_2'' m_2'' + \dots &= (p_1'' + p_2'' + \dots) B + p_1'' x_1 + p_2'' x_2 \dots, \\ p_1''' m_1''' + p_2''' m_2''' + \dots &= (p_1''' + p_2''' + \dots) C + p_1''' x_1 + p_2''' x_2 \dots, \\ & \quad \&c.; \end{aligned}$$

substitute in the second set the values of  $x_1, x_2, \dots$  given by the first, and the result will be a series of equations which may be written thus

$$\begin{aligned} (aa) A + (ab) B + (ac) C + \dots &= (an), \\ (ab) A + (bb) B + (bc) C + \dots &= (bn), \\ (ac) A + (bc) B + (cc) C + \dots &= (cn), \\ & \quad \&c. \end{aligned} \tag{16}$$

These equations determine  $A, B, C, \dots$ . That is to say, they determine certain values which are the most probable with reference to the observations at that station only.

But the condition to be satisfied is that the sum of the

squares of the errors of observation at *all* the stations is to be a minimum. Let this sum be expressed by  $2\Omega =$

$$\begin{aligned}
 & p_1(m_1 - x_1)^2 + p_1'(m_1' - x_1 - A)^2 + p_1''(m_1'' - x_1 - B)^2 \dots, \quad (17) \\
 & + p_2(m_2 - x_2)^2 + p_2'(m_2' - x_2 - A)^2 + p_2''(m_2'' - x_2 - B)^2 \dots, \\
 & + p_3(m_3 - x_3)^2 + p_3'(m_3' - x_3 - A)^2 + p_3''(m_3'' - x_3 - B)^2 \dots, \\
 & \qquad \qquad \qquad \&c.,
 \end{aligned}$$

which is to include all the stations. Suppose there are  $i$  equations of condition in the triangulation: these will be expressed thus

$$\begin{aligned}
 0 &= f_1 + a_1 A + \beta_1 B + \gamma_1 C + \dots, \quad (18) \\
 0 &= f_2 + a_2 A + \beta_2 B + \gamma_2 C + \dots, \\
 0 &= f_3 + a_3 A + \beta_3 B + \gamma_3 C + \dots, \\
 & \qquad \qquad \qquad \&c.
 \end{aligned}$$

Multiply these equations by multipliers  $I_1, I_2, I_3 \dots I_i$  of which the values are to be determined. Then the condition of minimum requires the following:—

$$\begin{aligned}
 \frac{d\Omega}{dx_1} &= 0, & \frac{d\Omega}{dx_2} &= 0, & \frac{d\Omega}{dx_3} &= 0 \dots; \\
 -\frac{d\Omega}{dA} &+ a_1 I_1 + a_2 I_2 + \dots a_i I_i = 0, \\
 -\frac{d\Omega}{dB} &+ \beta_1 I_1 + \beta_2 I_2 + \dots \beta_i I_i = 0, \\
 -\frac{d\Omega}{dC} &+ \gamma_1 I_1 + \gamma_2 I_2 + \dots \gamma_i I_i = 0, \\
 & \qquad \qquad \qquad \&c.
 \end{aligned}$$

To abbreviate, use this notation

$$\begin{aligned}
 [1] &= a_1 I_1 + a_2 I_2 + a_3 I_3 + \dots, \quad (19) \\
 [2] &= \beta_1 I_1 + \beta_2 I_2 + \beta_3 I_3 + \dots, \\
 [3] &= \gamma_1 I_1 + \gamma_2 I_2 + \gamma_3 I_3 + \dots, \\
 & \qquad \qquad \qquad \&c.,
 \end{aligned}$$

a symbol of the form  $[n]$  corresponding to each observed angle. With this substitution the preceding equations become

$$\begin{aligned}
 p_1 m_1 + p_1' m_1' + \dots &= (p_1 + p_1' \dots) x_1 + p_1' A + p_1'' B + \dots, \\
 p_2 m_2 + p_2' m_2' + \dots &= (p_2 + p_2' \dots) x_2 + p_2' A + p_2'' B + \dots, \\
 p_3 m_3 + p_3' m_3' + \dots &= (p_3 + p_3' \dots) x_3 + p_3' A + p_3'' B + \dots \\
 & \qquad \qquad \qquad \&c.;
 \end{aligned}$$



$$\begin{aligned}
 [1] + p_1' m_1' + p_2' m_2' + \dots &= (p_1' + p_2' \dots) A + p_1' x_1 + p_2' x_2 \dots, \\
 [2] + p_1'' m_1'' + p_2'' m_2'' + \dots &= (p_1'' + p_2'' \dots) B + p_1'' x_1 + p_2'' x_2 \dots, \\
 [3] + p_1''' m_1''' + p_2''' m_2''' + \dots &= (p_1''' + p_2''' \dots) C + p_1''' x_1 + p_2''' x_2 \dots, \\
 &\quad \&c.
 \end{aligned}$$

Substitute now the values of the  $x$ 's from the first equations in the second equations, and the result will be

$$\begin{aligned}
 [1] + (an) &= (aa) A + (ab) B + (ac) C + \dots, & (20) \\
 [2] + (bn) &= (ab) A + (bb) B + (bc) C + \dots, \\
 [3] + (cn) &= (ac) A + (bc) B + (cc) C + \dots, \\
 &\quad \&c.,
 \end{aligned}$$

corresponding with equations (16):  $(aa)$ ,  $(ab)$ ,  $(an)$ , ... being the same in both. But the  $A$ ,  $B$ ,  $C$ , ... in (16) are not the same as the  $A$ ,  $B$ ,  $C$ , ... in (20): the former are only approximate values, let them be denoted by  $A_1$ ,  $B_1$ ,  $C_1$ , ... and let

$$A = A_1 + (1), \quad B = B_1 + (2), \quad C = C_1 + (3),$$

and so on. Substitute these values in (20) and we have

$$\begin{aligned}
 [1] &= (aa)(1) + (ab)(2) + (ac)(3) + \dots, & (21) \\
 [2] &= (ab)(1) + (bb)(2) + (bc)(3) + \dots, \\
 [3] &= (ac)(1) + (bc)(2) + (cc)(3) + \dots, \\
 &\quad \&c.
 \end{aligned}$$

Each station will present a group of equations of this form in number less by unity than the number of signals there observed. These equations are to be solved and brought into the form

$$\begin{aligned}
 (1) &= (aa)[1] + (a\beta)[2] + (a\gamma)[3] + \dots, \\
 (2) &= (a\beta)[1] + (\beta\beta)[2] + (\beta\gamma)[3] + \dots, & (22) \\
 (3) &= (a\gamma)[1] + (\beta\gamma)[2] + (\gamma\gamma)[3] + \dots, \\
 &\quad \&c.,
 \end{aligned}$$

this notation for the coefficients being adopted for the sake of symmetry.

Substitute in these last the equivalents of  $[1]$ ,  $[2]$ ,  $[3]$ , ... from (19), and we get (1), (2), (3), ... expressed in terms of the multipliers  $I_1$ ,  $I_2$ ,  $I_3$ , ...

The equations of condition are to be formed with the angles

$A_1, B_1, C_1, \dots$  as resulting from the observations at the separate stations: this brings them into the form

$$\begin{aligned} 0 &= g_1 + a_1(1) + \beta_1(2) + \gamma_1(3) + \dots, \\ 0 &= g_2 + a_2(1) + \beta_2(2) + \gamma_2(3) + \dots, \\ 0 &= g_3 + a_3(1) + \beta_3(2) + \gamma_3(3) + \dots, \\ &\quad \&c., \end{aligned} \tag{23}$$

which are  $i$  in number. Next substitute in these the expressions for (1), (2), ... in terms of  $I_1 \dots I_i$ , and the result is a system of equations from which the  $i$  multipliers are to be obtained by elimination.

When this elimination, which is the most serious part of the operation, is effected, the numerical values of (1), (2), (3), ... easily follow.

In this manner Bessel calculated his triangulation in East Prussia, which contained 31 equations of condition and required the solution of a final system of equations of 31 unknown quantities. The method has since been extensively used notwithstanding the very heavy calculations demanded. It is now being carried out in the reduction of the Spanish triangulation.

### 8.

In the principal triangulation of Great Britain and Ireland there are 218 stations, at sixteen of which there are no observations, the number of observed bearings is 1554, and the number of equations of condition 920. The reduction of so large a number of observations in the manner we have been describing would have been quite impracticable, and it was necessary to have recourse to methods of approximation. In the first place, the final results of the observations at each station were obtained by an approximate solution of the equations (16), the nature of this approximation will be understood from the following table.

The first division of this table contains the observations to six signals on six different arcs; a constant quantity having been applied in each arc to the several circle readings in that arc so as to make  $R$  read the same (approximately the true azimuthal reading) on all. The means of the vertical columns are then taken, and the second part of the table contains the

differences between the individual results in the vertical columns and their mean. In a column to the right of this

$R$ 4° 21'	$A$ 11° 7'	$B$ 37° 34'	$C$ 97° 54'	$D$ 220° 3'	$E$ 271° 43'	MEAN.
"	"	"	"	"	"	
29.21	36.04	14.07	47.84	19.00	39.17	
29.21	35.91	.....	.....	18.18	38.22	
29.21	34.21	11.86	.....	.....	39.42	
29.21	32.41	10.71	46.05	16.30	.....	
29.21	.....	11.91	48.30	14.17	.....	
29.21	.....	.....	.....	18.59	41.04	
29.21	34.64	12.14	47.40	17.25	39.46	
0.00	+ 1.40	+ 1.93	+ 0.44	+ 1.75	- 0.29	+ 0.87
0.00	+ 1.27	.....	.....	+ 0.93	- 1.24	+ 0.24
0.00	- 0.43	- 0.28	.....	.....	- 0.04	- 0.19
0.00	- 2.23	- 1.43	- 1.35	- 0.95	.....	- 0.19
0.00	.....	- 0.23	+ 0.90	- 3.08	.....	- 0.60
0.00	.....	.....	.....	+ 1.34	+ 1.58	+ 0.97
28.34	35.17	13.20	46.97	18.13	38.30	
28.97	35.67	.....	.....	17.94	37.98	
29.40	34.40	12.05	.....	.....	39.61	
30.40	33.60	11.90	47.24	17.49	.....	
29.81	.....	12.51	48.90	14.77	.....	
28.24	.....	.....	.....	17.62	40.07	
29.19	34.71	12.42	47.70	17.19	38.99	

portion of the table are placed the means of these small quantities in the corresponding horizontal lines. In the third part of the table these last small quantities, one corresponding to each arc, are applied with contrary signs to the corresponding readings in the first part of the table. The means of the vertical columns as they now stand are taken as the true or most probable bearings.

The weights of these values of the bearings are formed by taking the differences between the individual results in each vertical column and their mean and summing the squares of these differences: thus, see page 56,

$$w = \frac{n^2}{2 \sum (e^2)},$$

$n$  being the number of observations of the bearing in question.

The final weights so obtained would have been greatly increased if it had been allowable to reject discordant observations, but this has never been done unless the observer has made a remark that such an observation ought to be rejected. Observations taken under favourable circumstances are doubtless more valuable than observations under less favourable circumstances; but how to assign their relative numerical value is a question admitting of no general solution. 'It appears that the longer time one is compelled to bestow upon observations under less favourable circumstances, in a great measure compensates external disadvantage, and that causes of error of observation of which the observer himself has not been conscious, often influence him no less than those which obtrude themselves upon him' (Bessel, *Gradmessung in Ostpreussen*). It has indeed been often noticed that an observation to which the observer has attached a remark to the effect that the bisection was unsatisfactory, or that the light was bad, or any other expression of doubt, has been found to agree with singular precision with the general mean.

Thus then are obtained at each station the bearings of all the other stations with their respective weights. The problem then takes this shape:—to determine a system of corrections to these bearings such that the sum of their squares, each multiplied by the corresponding weight, shall be a minimum: this is different from Bessel's solution, where the actual sum of the squares of all the corrections at all the stations was made a minimum. The modified problem, without sacrificing much, is very much more practicable.

Let the observed bearings be numbered consecutively, and let  $x_n$  be the correction to the  $n^{\text{th}}$  bearing, of which let the weight be  $w_n$ . Then we have

$$\begin{aligned}\epsilon_1 &= a_1 x_1 + a_2 x_2 + a_3 x_3 \dots, \\ \epsilon_2 &= b_1 x_1 + b_2 x_2 + b_3 x_3 \dots, \\ \epsilon_3 &= c_1 x_1 + c_2 x_2 + c_3 x_3 \dots, \\ &\quad \&c.; \\ 2\Omega &= w_1 x_1^2 + w_2 x_2^2 + w_3 x_3^2 \dots,\end{aligned}\tag{24}$$

being the equations of condition of the system, and a function  $2\Omega$  of the corrections which is to be made a minimum. Differentiate the equations of condition after multiplying them by  $I_1, I_2, I_3, \dots$ , and adding to  $-d\Omega$ , make the coefficients of  $dx_1, dx_2, dx_3, \dots$  in the sum severally equal to zero. Thus

$$\begin{aligned} w_1 x_1 &= a_1 I_1 + b_1 I_2 + c_1 I_3 \dots, \\ w_2 x_2 &= a_2 I_1 + b_2 I_2 + c_2 I_3 \dots, \\ w_3 x_3 &= a_3 I_1 + b_3 I_2 + c_3 I_3 \dots, \\ &\quad \&c. \end{aligned} \tag{25}$$

Substitute these in the equations of condition, and the result is

$$\begin{aligned} \epsilon_1 &= \left(\frac{aa}{w}\right) I_1 + \left(\frac{ab}{w}\right) I_2 + \left(\frac{ac}{w}\right) I_3 \dots, \\ \epsilon_2 &= \left(\frac{ab}{w}\right) I_1 + \left(\frac{bb}{w}\right) I_2 + \left(\frac{bc}{w}\right) I_3 \dots, \\ \epsilon_3 &= \left(\frac{ac}{w}\right) I_1 + \left(\frac{bc}{w}\right) I_2 + \left(\frac{cc}{w}\right) I_3 \dots, \\ &\quad \&c. \end{aligned} \tag{26}$$

Here we have a system of numerical equations equal in number to the equations of condition, and by their solution are obtained numerical values of  $I_1, I_2, I_3, \dots$ . These substituted in (25) give directly the required values of  $x_1, x_2, x_3, \dots$ . After the application of these corrections to the observed bearings, all the geometrical requirements will be fulfilled, and that with the least possible alteration, in the aggregate, of the original observations.

The different steps of the process are then as follows:—First: the obtaining of the geometrical equations of condition supplied by the connection of the triangulation. Second: the substitution in these equations of the observed bearings, each with its unknown correction appended. Third: the equations of condition being written out in their algebraic form (24), and unknown multipliers assumed, the equations (25) are formed. Fourth: from these equations the corrections must be obtained in terms of  $I_1, I_2, I_3, \dots$  and substituted in the equations of condition. Fifth: these equations must now be solved and numerical values will result for  $I_1, I_2, I_3, \dots$ . Sixth: the substitution of the values of these multipliers in the equations (25) whereby the corrections  $x_1, x_2, x_3, \dots$  become known.

Seventh: the verification of the work by the substitution of the corrections in the equations of condition, and by the working out of the whole triangulation. The following test may also be applied. Supposing  $x_1 x_2 x_3, \dots$  to be the corrections to the bearings at any *one* station,  $w_1 w_2 w_3, \dots$  the corresponding weights, then it is easy to show that

$$w_1 x_1 + w_2 x_2 + w_3 x_3 \dots = 0.$$

If  $e_n$  be the actual error of the  $n^{\text{th}}$  bearing, the error of the adopted value of that bearing is  $e_n + x_n$ . Now we may express the  $x$ 's in terms of all the  $e$ 's: for by inversion of the equations (26) the  $I$ 's may be expressed in terms of the  $e$ 's, and these last are connected with the actual errors by the equations

$$\begin{aligned} -\epsilon_1 &= a_1 e_1 + a_2 e_2 + a_3 e_3 \dots, \\ -\epsilon_2 &= b_1 e_1 + b_2 e_2 + b_3 e_3 \dots, \\ -\epsilon_3 &= c_1 e_1 + c_2 e_2 + c_3 e_3 \dots, \\ &\quad \&c. \end{aligned}$$

Let the multipliers  $I_1 I_2 I_3, \dots$  by means of (26) be expressed in terms of  $\epsilon_1 \epsilon_2 \epsilon_3, \dots$  thus

$$\begin{aligned} I_1 &= (a a) \epsilon_1 + (a \beta) \epsilon_2 + (a \gamma) \epsilon_3 \dots, \\ I_2 &= (a \beta) \epsilon_1 + (\beta \beta) \epsilon_2 + (\beta \gamma) \epsilon_3 \dots, \\ I_3 &= (a \gamma) \epsilon_1 + (\beta \gamma) \epsilon_2 + (\gamma \gamma) \epsilon_3 \dots, \\ &\quad \&c.; \end{aligned} \tag{27}$$

and make use of symbols  $\lambda_1 \lambda_2 \lambda_3, \dots$  such that

$$\begin{aligned} \lambda_1 &= (a a) a_1 + (a \beta) b_1 + (a \gamma) c_1 \dots, \\ \lambda_2 &= (a \beta) a_1 + (\beta \beta) b_1 + (\beta \gamma) c_1 \dots, \\ \lambda_3 &= (a \gamma) a_1 + (\beta \gamma) b_1 + (\gamma \gamma) c_1 \dots, \\ &\quad \&c. \end{aligned} \tag{28}$$

Then

$$\begin{aligned} w_1 x_1 &= \lambda_1 \epsilon_1 + \lambda_2 \epsilon_2 + \lambda_3 \epsilon_3 \dots = -(\lambda_1 a_1 + \lambda_2 b_1 + \lambda_3 c_1 \dots) e_1, \\ &\quad -(\lambda_1 a_2 + \lambda_2 b_2 + \lambda_3 c_2 \dots) e_2, \\ &\quad -(\lambda_1 a_3 + \lambda_2 b_3 + \lambda_3 c_3 \dots) e_3, \\ &\quad \&c. \end{aligned}$$

Similarly  $x_2 x_3, \dots$  may be expressed in terms of  $e_1 e_2 e_3, \dots$

Consider now the probable error of  $e_1 + x_1$ . If we write

$$w_1 x_1 = p_1 e_1 + p_2 e_2 + p_3 e_3 \dots,$$

then  $w_1 (x_1 + e_1) = (w_1 + p_1) e_1 + p_2 e_2 + p_3 e_3 + \dots$

Suppose that  $\epsilon$  is the probable error of an observed bearing to

which appertains the weight unity, then the probable error corresponding to a weight  $w$  will be  $\varepsilon : \sqrt{w}$ . Therefore the probable error of  $w_1 (x_1 + e_1)$  is

$$\pm \varepsilon \left\{ w_1 + 2 p_1 + \frac{p_1^2}{w_1} + \frac{p_2^2}{w_2} + \frac{p_3^2}{w_3} + \dots \right\}^{\frac{1}{2}}. \quad (29)$$

Now

$$\frac{p_1^2}{w_1} = \left( \lambda_1 \frac{a_1}{w_1} + \lambda_2 \frac{b_1}{w_1} + \lambda_3 \frac{c_1}{w_1} \dots \right) \left( \lambda_1 a_1 + \lambda_2 b_1 + \lambda_3 c_1 \dots \right),$$

which we shall arrange thus

$$\begin{aligned} \frac{p_1^2}{w_1} &= \lambda_1 \lambda_1 \frac{a_1 a_1}{w_1} + \lambda_1 \lambda_2 \frac{a_1 b_1}{w_1} + \lambda_1 \lambda_3 \frac{a_1 c_1}{w_1} + \dots, \\ &+ \lambda_1 \lambda_2 \frac{a_1 b_1}{w_1} + \lambda_2 \lambda_2 \frac{b_1 b_1}{w_1} + \lambda_2 \lambda_3 \frac{b_1 c_1}{w_1} + \dots, \\ &+ \lambda_1 \lambda_3 \frac{a_1 c_1}{w_1} + \lambda_2 \lambda_3 \frac{b_1 c_1}{w_1} + \lambda_3 \lambda_3 \frac{c_1 c_1}{w_1} + \dots, \\ &\quad \&c. \end{aligned}$$

These we have to add to similar expressions in  $a_2 b_2 c_2, \dots$  thus

$$\begin{aligned} \Sigma \left( \frac{p^2}{w} \right) &= \lambda_1 \lambda_1 \left( \frac{a a}{w} \right) + \lambda_1 \lambda_2 \left( \frac{a b}{w} \right) + \lambda_1 \lambda_3 \left( \frac{a c}{w} \right) \dots, \quad (30) \\ &+ \lambda_1 \lambda_2 \left( \frac{a b}{w} \right) + \lambda_2 \lambda_2 \left( \frac{b b}{w} \right) + \lambda_2 \lambda_3 \left( \frac{b c}{w} \right) \dots, \\ &+ \lambda_1 \lambda_3 \left( \frac{a c}{w} \right) + \lambda_2 \lambda_3 \left( \frac{b c}{w} \right) + \lambda_3 \lambda_3 \left( \frac{c c}{w} \right) \dots, \\ &\quad \&c. \end{aligned}$$

But the mutual relations of the equations (26) (27) give the following transformation of (28),

$$\begin{aligned} a_1 &= \left( \frac{a a}{w} \right) \lambda_1 + \left( \frac{a b}{w} \right) \lambda_2 + \left( \frac{a c}{w} \right) \lambda_3 \dots, \\ b_1 &= \left( \frac{b a}{w} \right) \lambda_1 + \left( \frac{b b}{w} \right) \lambda_2 + \left( \frac{b c}{w} \right) \lambda_3 \dots, \\ c_1 &= \left( \frac{c a}{w} \right) \lambda_1 + \left( \frac{c b}{w} \right) \lambda_2 + \left( \frac{c c}{w} \right) \lambda_3 \dots, \\ &\quad \&c. \end{aligned}$$

Thus by addition of the vertical columns of (30)

$$\Sigma \left( \frac{p^2}{w} \right) = \lambda_1 a_1 + \lambda_2 b_1 + \lambda_3 c_1 + \dots = -p_1,$$

which substituted in (29) that expression becomes

$$\pm \epsilon (w_1 + p_1)^{\frac{1}{2}},$$

and restoring the value of  $p_1$ , we have for the probable error of the corrected bearing, corresponding to  $x_1$ ,

$$\pm \epsilon \left\{ \frac{1}{w_1} - \frac{1}{w_1^2} (\lambda_1 a_1 + \lambda_2 b_1 + \lambda_3 c_1 \dots) \right\}^{\frac{1}{2}}. \quad (31)$$

The probable error of the distance between any two stations in the triangulation, or of the angle subtended at any station by any two other stations, may also be expressed; but for this we must refer to Gauss: *Supplementum theoriæ combinationis observationum erroribus minimis obnoxia*, Gottingen, 1826; or to the investigations of General Walker, in the second volume of the *Account of the Great Trigonometrical Survey of India*, where the subject is very elaborately worked out.

The minimum value of  $2\Omega = w_1 x_1^2 + w_2 x_2^2 + w_3 x_3^2 \dots$  is easily shown to be

$$2\Omega = I_1 \epsilon_1 + I_2 \epsilon_2 + I_3 \epsilon_3 + \dots$$

In order to avoid the solution of the equations containing 920 unknown quantities in the triangulation of Great Britain and Ireland, the network covering the kingdom was divided into a number of blocks, each presenting a not unmanageable number of equations of condition. One of these being corrected or computed independently of the others, the corrections so obtained were substituted (as far as they entered) in the equations of condition of the next block, and the sum of the squares of the remaining equations in that figure made a minimum. The corrections thus obtained for the second block were substituted in the third and so on. Four of the blocks are independent commencements, having no corrections from adjacent figures carried into them. The number of blocks is 21: in 9 of them the number of equations of condition is not less than 50: and in one case the number is 77. These calculations—all in duplicate—were completed in two years and a half—an average of eight computers being employed<sup>1</sup>.

The equations of condition that would have been required

<sup>1</sup> In connection with so great a work successfully accomplished, it is but right to remark how much it was facilitated by the energy and talents of the chief computer Mr. James O'Farrell.



to make the triangulation conform to the measured lengths of the base lines were not introduced, as they would have very greatly increased the labour, already sufficiently serious.

## 9.

When once the corrections to the several observed bearings have been found as described above, the calculation of the distances by Legendre's Theorem is sufficiently simple and straightforward. But if the equations of condition binding the triangulation to an exact reproduction of the lengths of the measured base lines have been omitted, we have still to consider what shall be taken as the absolute length of any one side in the triangulation. Let  $x$  be the required length of any one side; and let  $\epsilon_1 x, \epsilon_2 x, \epsilon_3 x, \dots$  be the lengths of the base lines as inferred from the ratios  $\epsilon_1 \epsilon_2 \epsilon_3 \dots$  given by the triangulation of the specified side to those base lines. Then if  $B_1 B_2 B_3 \dots$  be the measured lengths of the base lines,  $w_1 w_2 w_3 \dots$  the corresponding weights,  $x$  must be taken so as to render a minimum the expression

$$w_1 (\epsilon_1 x - B_1)^2 + w_2 (\epsilon_2 x - B_2)^2 + w_3 (\epsilon_3 x - B_3)^2 + \dots,$$

that is to say

$$x = \frac{w_1 \epsilon_1 B_1 + w_2 \epsilon_2 B_2 + w_3 \epsilon_3 B_3 + \dots}{w_1 \epsilon_1^2 + w_2 \epsilon_2^2 + w_3 \epsilon_3^2 + \dots}.$$

In this kingdom six base lines have been measured, the earlier ones with steel chains, the two most recent with Colby's compensation apparatus. The absolute length of any side in the triangulation is made to depend entirely on the two last. The following table contains the measured lengths of the bases, and their lengths in the corrected triangulation—

DATE.	PLACE.	MEASURED.	IN TRIANGULATION.	DIFFERENCE.	COUNTY.
		ft.	ft.	ft.	
1791	Hounslow Heath	27406.19	27406.36	+ 0.17	Middlesex.
1794	Salisbury Plain	36576.83	36577.66	+ 0.83	Wilts.
1801	Misterton Carr	26344.06	26343.87	- 0.19	Lincoln.
1806	Rhuddlan Marsh	24516.00	24517.60	+ 1.60	Flint.
1817	Belhelvie... ..	26517.53	26517.77	+ 0.24	Aberdeen.
1827	Lough Foyle ...	41640.89	41641.10	+ 0.21	Londonderry.
1849	Salisbury Plain	36577.86	36577.66	- 0.20	Wilts.

The only serious difference here shown is in the case of the base at Rhuddlan, and this is owing in great measure to the bad connection of the line with the adjacent triangulation.

10.

We shall now give a simple example of the calculation of corrections to observed bearings in a small piece of the triangulation of this country. The points are South Berule, *B*, in the Isle of Man; Merrick, *M*, in Kircudbrightshire; Slieve Donard *D*, in the County Down, Ireland; Snowdon, *S*, in the North of Wales; and Sca Fell, *F*, in Cumberland. The line *DF* in the diagram being broken towards *F*, intimates that Sca Fell did not observe Slieve Donard.

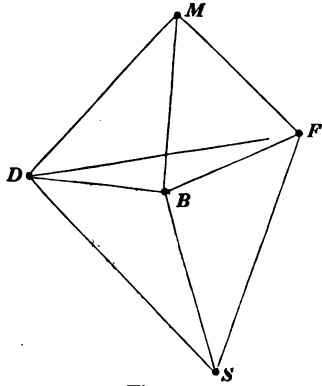

Fig. 49.

Now in the triangle *BMD*, the three angles being observed, we have first

$$BMD + MDB + DBM = 180^\circ + \epsilon_1,$$

where  $\epsilon_1$  is the spherical excess of the triangle. Secondly, the triangle *BDS* gives similarly

$$BDS + DSB + SBD = 180^\circ + \epsilon_2.$$

Thirdly, the triangle *BSF* gives

$$BSF + SFB + FBS = 180^\circ + \epsilon_3.$$

Now the points *MBF* being fixed the observation of the angles *BMF*, *BFM*, which are known, brings in two equations of condition; one is

$$BMF + MFB + FBM = 180^\circ + \epsilon_4,$$

and the second, the 'side equation'

$$\frac{\sin BSF \cdot \sin BDS \cdot \sin BMD \cdot \sin BFM}{\sin BFS \cdot \sin BSD \cdot \sin BDM \cdot \sin BMF} = 1.$$

Finally, the observation *DF* brings in the side equation

$$\frac{\sin FMD \cdot \sin FBM \cdot \sin FDB}{\sin FDM \cdot \sin FMB \cdot \sin FBD} = 1.$$

In order to express these equations in numerical form we give in the following table the results of the observations at the different stations on which the calculation is to be based. The last column but one gives the reciprocal of the weight of each observed bearing: and the last column the number of observations in each case. For  $x_1, x_2, x_3, \dots$ , we write, as is usual (1), (2), (3),  $\dots$ .

OBSERVING STATIONS.	STATIONS OBSERVED.	OBSERVED BEARING WITH SYMBOLICAL CORRECTION.	$\frac{1}{w}$	NO. OF OBSERVATIONS.
Merrick ...	South Berule	6° 47' 45.72 + (1)	0.11	35
	Slieve Donard	41 52 49.08 + (2)	0.19	24
	Sca Fell ...	312 48 54.59 + (3)	0.13	32
Slieve Donard	Merrick ...	220 41 42.50 + (4)	0.08	8
	Sca Fell ...	259 5 10.02 + (5)	0.46	13
	South Berule	271 53 16.88 + (6)	0.37	19
	Snowdon ...	314 38 39.43 + (7)	0.22	21
South Berule	Slieve Donard	92 54 35.32 + (8)	0.61	24
	Merrick ...	186 38 21.37 + (9)	0.82	20
	Sca Fell ...	249 44 48.27 + (10)	0.50	17
	Snowdon ...	341 41 50.13 + (11)	0.62	20
Sca Fell ...	Snowdon ...	20 38 31.85 + (12)	2.93	3
	South Berule	70 55 36.88 + (13)	0.98	6
	Merrick ...	133 50 41.88 + (14)	1.88	7
Snowdon ...	Slieve Donard	136 7 51.72 + (15)	2.17	4
	South Berule	162 10 9.13 + (16)	10.10	4
	Sca Fell ...	199 56 40.20 + (17)	1.35	3

The formation of the four angle equations will then stand as follows,

$$\begin{array}{r}
 \text{South Berule ... } 93^{\circ} 43' 46.05 - (8) + (9) \\
 \text{Slieve Donard ... } 51 11 34.38 - (4) + (6) \\
 \text{Merrick ... } 35 5 3.36 - (1) + (2)
 \end{array}$$

$$\begin{array}{r}
 180 \quad 0 \quad 23.79 \\
 \epsilon_1 = \quad 22.922
 \end{array}$$

$$\begin{array}{r}
 \therefore 0 = + 0.868 - (1) + (2) - (4) + (6) \\
 \qquad \qquad \qquad - (8) + (9).
 \end{array}$$

South Berule ...	111° 12' 45.19" + (8) - (11)	
Slieve Donard ...	42 45 22.55 - (6) + (7)	
Snowdon ...	26 2 17.41 - (15) + (16)	
	180 0 25.15	
	$\epsilon_2 =$ 24.433	
	$\therefore 0 = + 0.717 - (6) + (7) + (8) - (11)$	
	$- (15) + (16).$	

South Berule ...	91° 57' 1.86" - (10) + (11)	
Snowdon ...	37 46 31.07 - (16) + (17)	
Sca Fell ...	50 17 5.03 - (12) + (13)	
	180 0 37.96	
	$\epsilon_3 =$ 32.258	
	$\therefore 0 = + 5.702 - (10) + (11) - (12) + (13)$	
	$- (16) + (17).$	

South Berule ...	63° 6' 26.90" - (9) + (10)	
Sca Fell ...	62 55 5.00 - (13) + (14)	
Merrick ...	53 58 51.13 + (1) - (3)	
	180 0 23.03	
	$\epsilon_4 =$ 25.230	
	$\therefore 0 = - 2.200 + (1) - (3) - (9) + (10)$	
	$- (13) + (14).$	

In the calculation of the side equations, one third of the spherical excess has been subtracted from the observed angles in the different triangles: this is not necessary, but it is generally convenient to do so. Using eight figures of logarithms, and understanding that (1), (2) ... are expressed in seconds the calculation stands thus,

log sin	BSF ...	9.7871239,0	+ 27,17	{ - (16) + (17) },
	„ BDS ...	9.8317751,2	+ 22,77	{ - (6) + (7) },
	„ BMD ...	9.7594791,7	+ 29,98	{ - (1) + (2) },
	„ BFM ...	9.9495547,9	+ 10,77	{ - (13) + (14) },
log cosec	BFS ...	0.1139629,9	- 17,49	{ - (12) + (13) },
	„ BSD ...	0.3576004,5	- 43,10	{ - (15) + (16) },
	„ BDM ...	0.1083304,9	- 16,93	{ - (4) + (6) },
	„ BMF ...	0.0921606,2	- 15,31	{ + (1) - (3) },
	Sum			- 124,7 + &c.;

log sin	<i>FMD</i> ...	9.9999417,3 + 0,34 {+(2)−(3)},
„	<i>FBM</i> ...	9.9502860,1 + 10,68 {−(9)+(10)},
„	<i>FDB</i> ...	9.3455070,3 + 92,67 {−(5)+(6)},
log cosec	<i>FDM</i> ...	0.2069267,5 − 26,58 {−(4)+(5)},
„	<i>FMB</i> ...	0.0921606,2 − 15,31 {+(1)−(3)},
„	<i>FBD</i> ...	0.4052080,5 − 49,21 {+(8)−(10)},
	Sum	301,9 + &c.

Thus the fifth and sixth equations are

$$0 = -124.7 - 45.29 (1) + 29.98 (2) + 15.31 (3) + 16.93 (4) \\ - 39.70 (6) + 22.77 (7) + 17.49 (12) - 28.26 (13) \\ + 10.77 (14) + 43.10 (15) - 70.27 (16) + 27.17 (17).$$

$$0 = + 301.9 - 15.31 (1) + 0.34 (2) + 14.97 (3) \\ + 26.58 (4) - 119.25 (5) + 92.67 (6) \\ - 49.21 (8) - 10.68 (9) + 59.89 (10).$$

Now multiply these six equations by  $I_1, I_2 \dots I_6$ , and form the equations (25) page 240; they will stand thus,

$$\frac{1}{0.11} (1) = -I_1 + I_4 - 45.29 I_5 - 15.31 I_6, \\ \frac{1}{0.19} (2) = +I_1 + 29.98 I_5 + 0.34 I_6, \\ \frac{1}{0.13} (3) = -I_4 + 15.31 I_5 + 14.97 I_6, \\ \frac{1}{0.08} (4) = -I_1 + 16.93 I_5 + 26.58 I_6, \\ \frac{1}{0.46} (5) = -119.25 I_6, \\ \frac{1}{0.37} (6) = +I_1 - I_2 - 39.70 I_5 + 92.67 I_6, \\ \frac{1}{0.22} (7) = +I_2 + 22.77 I_5, \\ \frac{1}{0.61} (8) = -I_1 + I_2 - 49.21 I_6, \\ \frac{1}{0.82} (9) = +I_1 - I_4 - 10.68 I_6, \\ \frac{1}{0.50} (10) = -I_3 + I_4 + 59.89 I_6, \\ \frac{1}{0.62} (11) = -I_2 + I_3, \\ \frac{1}{2.93} (12) = -I_3 + 17.49 I_5, \\ \frac{1}{0.98} (13) = +I_3 - I_4 - 28.26 I_5, \\ \frac{1}{1.88} (14) = +I_4 + 10.77 I_5, \\ \frac{1}{2.17} (15) = -I_2 + 43.10 I_5, \\ \frac{1}{10.1} (16) = +I_2 - I_3 - 70.27 I_5, \\ \frac{1}{1.35} (17) = +I_3 + 27.17 I_5.$$

The next step is the multiplication of these out, so as to express (1), (2), (3) ... in terms of  $I_1, I_2, I_3 \dots$  directly. This done and the resulting (1), (2), (3) ... substituted in the six equations of condition, the following system of equations is obtained :

	$I_1$	$I_2$	$I_3$	$I_4$	$I_5$	$I_6$
o = + 0.868	+ 2.18	- 0.98		- 0.93	- 5.365	+ 55.171
o = + 0.717	- 0.98	+ 14.09	- 10.72		- 783.556	- 64.306
o = + 5.702		- 10.72	+ 16.48	- 1.48	+ 667.466	- 29.945
o = - 2.200	- 0.93		- 1.48	+ 4.42	+ 40.970	+ 35.072
o = - 124.7	- 5.365	- 783.556	+ 667.466	+ 40.970	+ 57944.1	- 1217.22
o = + 301.9	+ 55.171	- 64.306	- 29.945	+ 35.072	- 1217.22	+ 13194.5

From these equations the numerical values of  $I_1, I_2, I_3 \dots$  have to be eliminated, and this is the most troublesome part of the whole operation. The logarithmic values of the multipliers are found to be these,

$$\begin{aligned} \log I_1 &= 9.2707823, & \log I_4 &= 9.6787289, \\ \log I_2 &= 9.9693096 n, & \log I_5 &= 6.7453816 n, \\ \log I_3 &= 9.9750836 n, & \log I_6 &= 8.5005758 n; \end{aligned}$$

the  $n$  following a logarithm signifying that the natural number is to be taken negatively. It is a simple matter now to get the values of (1), (2), (3) ...; they will be found to be as follows,

$$\begin{aligned} (1) &= +0.088, & (7) &= -0.208, & (13) &= -1.378, \\ (2) &= +0.030, & (8) &= +0.268, & (14) &= +0.886, \\ (3) &= -0.125, & (9) &= +0.039, & (15) &= +1.970, \\ (4) &= -0.083, & (10) &= -0.237, & (16) &= +0.521, \\ (5) &= +1.737, & (11) &= -0.008, & (17) &= -1.295. \\ (6) &= -0.664, & (12) &= +2.738, & & \end{aligned}$$

These, finally, are the required corrections to the observed bearings; and the subsequent calculation of the triangles presents no discrepancies.

The side Slieve Donard to Sca Fell is the longest in the British triangulation, being upwards of 111 miles in length.

## 11.

It may be well here to exemplify the calculation of coordinates by the formulæ of pages 49, 50. Starting from  $D$  we shall calculate the coordinates of  $F$  and  $M$  measured along and perpendicular to the meridian of  $D$ , which here corresponds to the  $P$  of fig. 12. In the first place the solution of the triangle  $DFM$  is as shown in this table: the third column containing the seconds of the angles in the preceding column diminished each by  $\frac{1}{3}\epsilon$ .

STATIONS.	CORRECTED ANGLES.	$-\frac{1}{3}\epsilon$	LOG SINES.	LOG DISTANCES.	DISTANCES.
	° ' "	"			ft.
Merrick	89 3 54.645	41.331	9.99994173	5.76867715	587052.78
Donard	38 23 29.340	16.025	9.79307805	5.56181347	364597.32
Sea Fell	52 33 15.959	2.644	9.89976146	5.66849688	466119.08
	$\epsilon = 39.944$				

At  $D$  we have given  $\alpha_1 = 79^\circ 5' 16''.000$  being the known azimuth there of  $F$ : also  $DF = s_1$  is the first distance in the preceding table. Retaining the notation of the article referred to above, put further

$$\alpha_1 - \frac{1}{3}\epsilon = \alpha_1', \quad \alpha_1 - \frac{2}{3}\epsilon_1 = \alpha_1'',$$

and let the factor  $(2\rho \sin 1'')^{-1}$  for the calculation of spherical excess be expressed by  $E$ . Then for the coordinates of Sea Fell,

$\alpha_1' = 79\ 5\ 10.981$	logs	logs
$\alpha_1'' = 79\ 5\ 5.961$	$\sin 9.99207534$	$\sin \alpha_1\ 9.99208$
$s_1 = 587052.78$	$\cos 9.27727150$	$\cos \alpha_1\ 9.27716$
$x_1 = 111160.03$	$5.76867715$	$s_1^2\ 1.53735$
$y_1 = 576435.19$	$5.04594865$	$E\ 0.37117$
	$5.76075049$	$\epsilon_1 = 15''.058\ 1.17776$

To proceed from  $F$  to  $M$ , we have  $\sigma_1 = 127^\circ 26' 44''.041$ , being the supplement of the angle  $DFM$ : also

$$\alpha_2 = \alpha_1 - \sigma_1 - \epsilon_1 - \frac{1}{2}\epsilon' = -48^\circ 22' 15''.912,$$

$\epsilon'$  being obtained by a preliminary calculation of  $x_2'$ . Then

for the coordinates of Merrick,

	° ' "	logs	logs
$-a_2' = 48\ 22\ 10.740$		$\sin\ 9.87358000$	$\sin\ a_2\ 9.87359\ n$
$\frac{1}{2}\ \epsilon' - a_2'' = 48\ 22\ 38.382$		$\cos\ 9.82231330$	$\cos\ a_2\ 9.82237$
$s_2 = 364597.32$		$5.56181347$	$s_2^2\ 1.12362$
$-y_2' = 272516.92$		$5.43539347$	$E\ 0.37117$
$x_2' = 242173.59$		$5.38412677$	$\epsilon_2 = -15''.515\ 1.19075$
$\frac{1}{2}\ \epsilon' y_1\ \sin\ 1'' = 91.70$		$1.96237$	$x_2'\ 5.38413$
$y_2 = 303918.27$			$y_1\ 5.76075$
$x_2 = 353425.32$			$\frac{1}{2}\ \epsilon' = 32''.813\ 1.51605$

These values of  $x_2, y_2$  may be checked by proceeding direct from  $D$  to  $M$ : the calculation gives

$$x_2 = 353425.34, \quad y_2 = 303918.23.$$

## 12.

The diagram, page 252, shows the triangulation of the northern part of this kingdom, including Scotland, portions of England and of Ireland, and the Shetland Islands. The station Saxaford, at the northern extremity, is one of a close group of three stations, at each of which the latitude was observed as the extremity of the British arc of meridian. The straight dotted line proceeding northwards from the station Easington, on the north coast of Yorkshire, and passing a little to the left of Saxaford, is the meridian of Easington:  $S$  is the point in which a perpendicular from Saxaford meets the meridian line.

The other dotted lines indicate the manner in which the distance, Easington to  $S$ , was calculated: the calculation was made as follows. Astronomical observations at Easington showed that the azimuth there of Cheviot was  $38^\circ 48' 58''.68$  to the west of north. On the meridian so defined take a point  $A$ , whose distance from Easington is equal to the distance Easington—Cheviot. Join the point  $A$  with Cheviot and Mount Battock, and it is evident, since all the angles and distances in the triangulation are known, that we can determine the distance of  $A$  from Mount Battock, and also the angle at  $A$  between Mount Battock and the meridian. Next, take a point  $D$  in the same meridian whose distance from  $A$  is



equal to the side *A*—Mount Battock. Join *D* with Mount

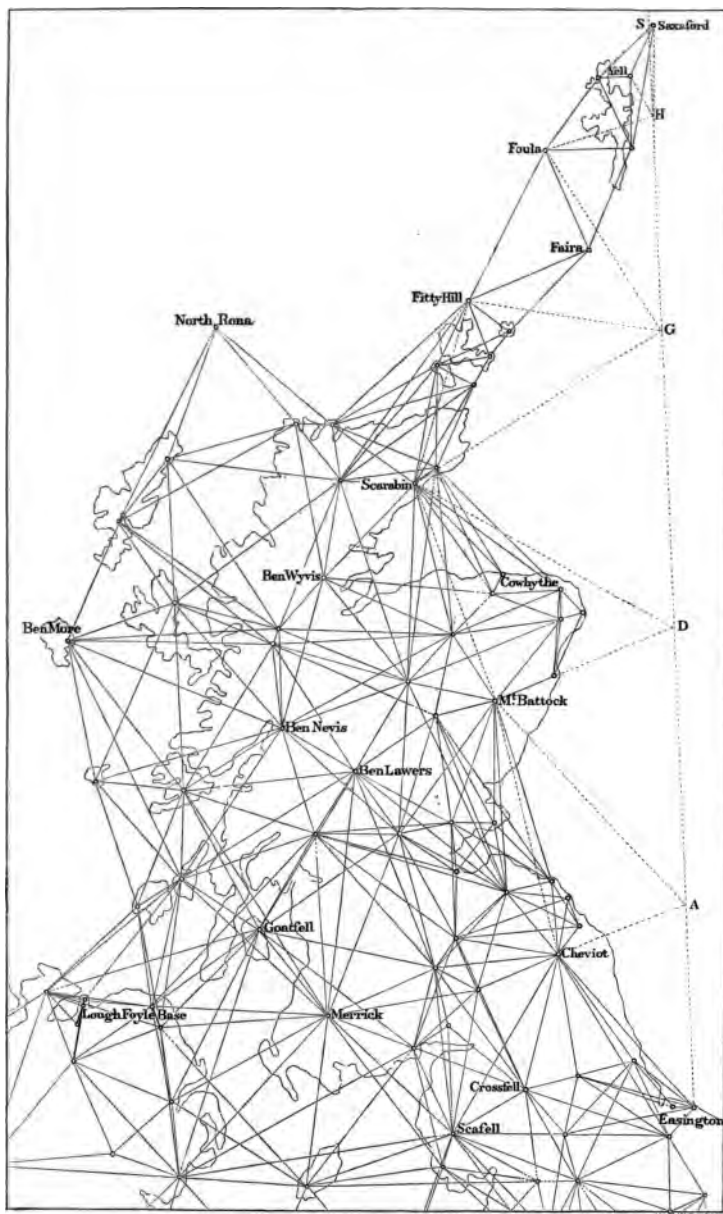

Fig. 50.

Battock and Scarabin take the point  $G$ , such that  $DG$  is equal to the distance  $D$  to Scarabin. Join  $G$  with Scarabin, Fitty Hill, and Foula, and take  $H$  such that  $GH$  is equal to the distance  $G$  to Foula. Join  $H$  with Foula, Yell, and Saxaford, and from the last point drop the perpendicular on the meridian, meeting it at  $S$ . On computing the several portions of the line Easington to  $A$ ,  $AD$ ,  $DG$ ,  $GH$ ,  $HS$ , their sum was found to be 2288427.29 feet, and the length of the perpendicular from Saxaford to  $S$ , 222.56 feet. The calculation was then repeated with an entirely different set of points with a resulting length of 2288427.38 feet, and for the perpendicular 221.94. Thus the distance from Easington to Saxaford is known, and the angle

$$\text{Cheviot : Easington : Saxaford} = 38^{\circ} 49' 18'' \cdot 767.$$

This example is given to show how the direct distances between remote points in the triangulation are obtained. In a similar manner were calculated the following results:

$$\begin{aligned} \text{The distance, Greenwich—Feaghmain} \\ = 2350102 \cdot 30 \text{ feet.} \end{aligned}$$

$$\begin{aligned} \text{The angle, Chingford : Greenwich : Feaghmain} \\ = 81^{\circ} 59' 11'' \cdot 857. \end{aligned}$$

Feaghmain is the most westerly trigonometrical station in Ireland, in the Island of Valencia : and Chingford is a station due north of Greenwich.

Also the following, Mount Kimmel being a station of the Belgian triangulation :

$$\begin{aligned} \text{The distance, Greenwich—Mount Kimmel} \\ = 694849 \cdot 31 \text{ feet.} \end{aligned}$$

$$\begin{aligned} \text{The angle, Chingford : Greenwich : Mount Kimmel} \\ = 110^{\circ} 26' 7'' \cdot 398. \end{aligned}$$

The connection of the triangulation of this country with that of France and Belgium was effected in 1861, in connection with M. Struve's proposed arc of longitude, extending from Feaghmain to Orsk, on the river Oural. The network connecting the coast of Kent and Sussex with Mount Kimmel in Belgium, is shown in the diagram, Fig. 51. Fairlight, Paddlesworth, and St. Peter's are stations in the English

triangulation, the two sides meeting at Paddlesworth are given, and also the angle in which they intersect: in addition to these a point, Coldham, was selected near Folkestone, commanding an excellent view of the French coast, and also seeing the stations at Fairlight and St. Peter's.

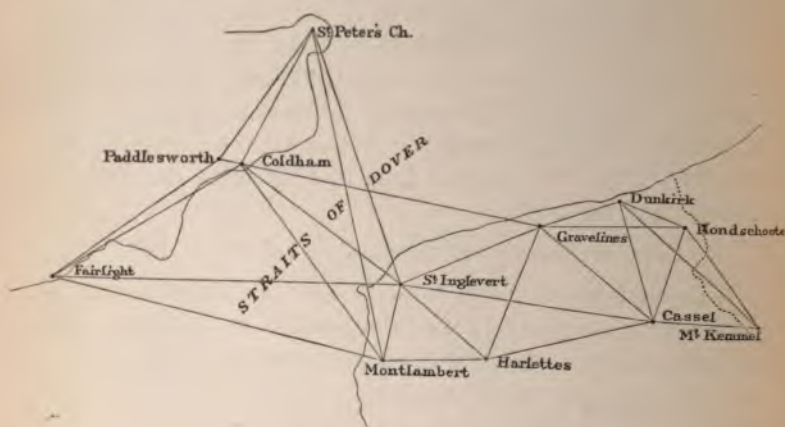

Fig. 51.

The necessary operations were conducted by English officers acting in concert with officers selected on the part of France. The observations—made independently—were commenced in June 1861 and finished in the following January. The following comparison of certain triangle sides expressed in metres as obtained from the English triangulation, and as obtained by the Belgians from their base of Ostend, is satisfactory enough: the second column gives the approximate distance in miles.

DISTANCES.	MILES.	ENGLISH.	BELGIAN.	DIFF.
		m.	m.	m.
Hondschoote—Kemmel	17.2	27612.80	27612.74	-0.06
Cassel—Hondschoote	13.3	21415.30	21415.34	+0.04
Cassel—Kemmel ...	14.3	22981.43	22981.18	-0.25
Dunkirk—Hondschoote	9.9	15918.98	15919.10	+0.12
Dunkirk—Cassel ...	17.1	27458.41	27458.40	-0.01

13.

The case in which the principal triangulation of a country consists—as in France, Spain, and India—of chains of triangles running north and south, crossed perpendicularly by chains running east and west, requires particular consideration. Consider the accompanying figure, representing portions of two pairs of chains enclosing a four-sided space: and let it be given that in each of the 25 triangles of which the closed

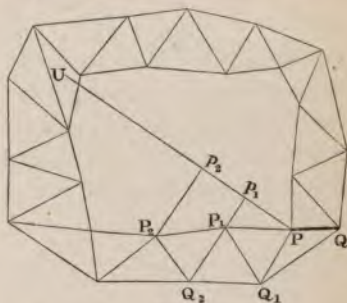

Fig. 52.

chain is composed, the three angles are observed, and say, with uniform precision. Let  $PQ$  be a base line, or at any rate a line of a given length: then excluding  $P$  and  $Q$ , there are 23 points in the figure requiring 46 angles to fix them; thus there must be  $3 \times 25 - 46 = 29$  equations of condition.

In any spherical polygon of  $n$  sides and area  $E$ ,  
 the sum of the interior angles  $= (n - 2) \pi + E$ ,  
 the sum of the exterior angles  $= (n + 2) \pi - E$ ,

and if we apply these to the exterior and interior polygons of our figure, we see that, if for instance  $n'$ ,  $E'$  be the number of sides, and area of the former,  $(n' + n) \pi + E' - E$  must be equal to the sum of all the angles of the triangles, and this condition is secured by making the sum of the angles of each of the  $n' + n = 13 + 12$  triangles,  $= \pi +$  the spherical excess. To these 25 conditions must be added that ( $A$ ) given by the sum of the angles of either of the polygons, and ( $B$ ) the side equation ensuring the correct reproduction of the length of  $PQ$  after working through all the triangles. There still remain two equations to be found.

The conditions as yet taken into consideration ensure that if starting with the length  $PQ$  we calculate through the successive triangles until  $PQ$  is again arrived at, then the

computed  $PQ$  is true in length and true in direction: but we have not ensured that the computed  $PQ$  is actually coincident with the true. Draw from  $P$  the arc of a great circle  $PU$ , making with  $PQ$  such an angle as that it shall divide the interior polygon into somewhat equal portions. From  $P_1, P_2, \dots$  drop the perpendiculars  $P_1p_1, P_2p_2, \dots$  upon  $PU$  and let  $Pp_n = X_n$ ;  $P_n p_n = Y_n$ : then, when, starting from  $P$  the calculation of these coordinates has been carried from point to point round the inner polygon until  $P$  is finally returned to, its  $X$  must be zero ( $C$ ) and its  $Y$  must be also zero ( $D$ ). These are the two equations required. Let  $A', B', C'$  be the observed angles of any triangle,  $e$  the error of their sum, and let the most probable angles to be adopted be

$$A' - \frac{1}{3}e + x, \quad B' - \frac{1}{3}e + y, \quad C' - \frac{1}{3}e - x - y.$$

These corrections at once fulfil in the case of each triangle the condition of making the sum of the angles of that triangle true, and thus the number of equations of condition is reduced to four ( $A$ ), ( $B$ ), ( $C$ ), ( $D$ ). And this number, viz. four, is the same for all simple closed chains, whatever be the number of triangles. The formation of the equations ( $A$ ) and ( $B$ ) in terms of all the  $x$ 's and  $y$ 's presents no difficulty. For the others; assuming, first the  $x$ 's and  $y$ 's zero, it is clear that using the angles  $A' - \frac{1}{3}e$ ,  $B' - \frac{1}{3}e$ ,  $C' - \frac{1}{3}e$ , each side and angle of the inner polygon has a definite numerical value which is to be calculated. Then by the formulæ of spherical trigonometry, page 50, calculate the coordinates  $X_1 Y_1, X_2 Y_2, \dots$  until the initial point is returned to, when, instead of getting zero, we get certain numerical values ( $X$ ) and ( $Y$ ) for the coordinates of that point.

But the symbols  $x, y, \dots$  introduce an increment to each side of the polygon and an increment to each angle: this increment there is no difficulty in expressing. For instance, if  $180^\circ + \sigma$  be one of the external angles of the inner polygon, then  $d\sigma$  is of the form  $x_{n-1} - x_n - y_n + y_{n+1}$ , and using the method of page 39,  $dS$  will involve generally six of the symbols  $x, y$  with coefficients not unity. Then having written down the expressions for the successive quantities  $d\sigma, dS$ , the formula (3) gives the total increments  $d(X)$  and

$d(Y)$  to be added to the values obtained for  $(X)$ ,  $(Y)$ . Thus the equations  $(C)$  and  $(D)$  are

$$(X) + d(X) = 0, \quad (Y) + d(Y) = 0.$$

Then we have to make a minimum the sum

$$\Sigma \left\{ \left( \frac{1}{3}e - x \right)^2 + \left( \frac{1}{3}e - y \right)^2 + \left( \frac{1}{3}e + x + y \right)^2 \right\},$$

or, which is the same,  $\Sigma \{x^2 + y^2 + (x+y)^2\}$  is to be a minimum—subject to four conditional equations:

$$0 = a_1x + b_1y + a_1'x' + b_1'y' + \dots,$$

$$0 = a_2x + b_2y + a_2'x' + b_2'y' + \dots,$$

$$0 = a_3x + b_3y + a_3'x' + b_3'y' + \dots,$$

$$0 = a_4x + b_4y + a_4'x' + b_4'y' + \dots$$

Proceeding as in previous cases, this resolves itself into the determination of four multipliers, by which finally the  $x$ 's and  $y$ 's are obtained.

Had another side, as  $HK$ , been a measured base this circumstance would have introduced an additional equation of condition.

The most elaborate calculations that have ever been undertaken for the reduction of triangulation by the method of least squares are those of the Indian Survey. The principal triangulation of India is formed of chains of triangles disposed as shown in the diagram, page 31. The axis of the system is the great arc of Colonel Everest, running from Cape Comorin to the Dehra Dun base in the Himalayas: the principal chains divide the triangulation into five geographical sections, four of which may be roughly described as quadrilaterals, the fifth in the south being trilateral. At the corners of the quadrilaterals are the base lines which, with one exception, were measured with Colby's apparatus.

As the extent of the operations quite precluded the idea of reducing the whole in one mass, as required by theoretical considerations, General Walker decided to treat separately the five sections specified above, reducing the figures in succession, upholding and maintaining the results determined for the one first reduced in the contiguous figures when they in turn were to be undertaken. This arrangement made it necessary to commence with that section of the work which was in all

its parts of the highest accuracy: this is the north-west quadrilateral<sup>1</sup> *abfi*. In this section of the work there are 128 single triangles and 110 polygons—including in that term quadrilaterals and complex figures—comprising a total number of 2418 observed angles. These polygons present in the aggregate 955 equations of condition, without considering the closings of circuits.

This being as a whole still unmanageable, it became necessary to obtain corrections to each separate figure, whether a simple triangle or a polygon, with regard only to the conditions presented by that figure itself. Thus, in the first instance, all the angles received corrections without regard to the closings of circuits.

For the purpose of the final adjustments of the circuits, the complex chains—composed as they are of single triangles and polygons—were replaced by simple chains composed of these single triangles and a selection of continuous triangles from the polygons: the polygons having been made consistent, it was so far immaterial how these triangles were selected. Then the already partially corrected angles *A*, *B*, *C* of any triangle receive symbolical corrections *x*, *y*, and  $-(x+y)$ , the sum of the squares of which multiplied by the respective weights is to be a minimum. The corrections *x*, *y*, ... are connected by equations which ensure the closing of the chains and the correct reproduction of the measured base line lengths. An inspection of the diagram shows that in the north-west quadrilateral there are five circuits to close, and, according to what we have seen in the preceding pages, this requires  $4 \times 5 = 20$  equations of condition. Besides these the four base lines give  $4 - 1 = 3$  additional equations.

With respect to the reproduction, by the corrected triangulation, of the measured length of the bases, it is necessary to remark that since in this calculation the exact weight of every observed angle has been strictly considered and brought into play so as to influence duly the final results, so also should the probable errors or weights of the measured bases, which are not errorless any more than the observed angles.

<sup>1</sup> *Account of the Operations of the Great Trigonometrical Survey of India*, by Col. J. T. Walker, C.B., R.E., F.R.S.; vol. ii, pages 30-32.

But General Walker has shown (vol. ii, page 265) that it is but reasonable, after considering all the facts of the case, to treat the base lines as errorless in comparison with the triangulation.

Let the adjoining diagram represent a succession of sides in a closing chain of triangles. Each side and each angle has a definite numerical value as given by the already partially corrected triangles, and to this numerical value is to be attached in each case a symbolical increment which can be expressed in terms of  $x$ 's and  $y$ 's. Now suppose, that starting from the point  $a$  with a definite latitude and a definite azimuth of one line there, the latitude and longitude of  $b$  is calculated and also the back azimuth of  $a$  at  $b$ . Let this process be repeated from  $b$  to  $c$ , and so on, until  $p$  is reached. The result will be that we get the latitude and longitude of  $p$  and the azimuth of the line  $pq$ . Then again, if proceeding by  $b', c', \dots$  we make corresponding calculations, we get a second set of values of latitude, longitude, and azimuth at  $p$ ; and the two sets must be equated respectively. Thus arise three equations<sup>1</sup>:

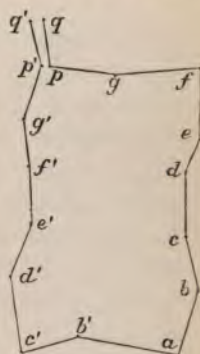

Fig. 53.

*Left route.*                      *Right route.*

Latitude,     $\Phi' + \Sigma (a' x' + b' y') = \Phi + \Sigma (a x + b y)$ ;

Longitude,    $\Omega' + \Sigma (a_1' x' + b_1' y') = \Omega + \Sigma (a_1 x + b_1 y)$ ;

Azimuth,     $A' + \Sigma (a_2' x' + b_2' y') = A + \Sigma (a_2 x + b_2 y)$ .

The fourth equation, an ordinary side equation, establishes the equality in length of  $pq$  with  $p'q'$ .  $\Phi' - \Phi$ ,  $\Omega' - \Omega$ , and  $A' - A$  are the circuit errors in latitude, longitude, and azimuth, as shown by the partially corrected triangles.

The manner in which the equations were formed is this.

Take first the linear equations which secure the reproduction of base line lengths ( $A, B, C, D$  are the Sironj,

<sup>1</sup> Comprised in Col. Walker's formulæ (121), vol. ii, page 176.



Dehra Dun, Chach, and Karachi bases) and also identity of

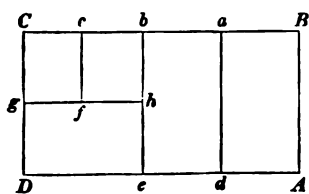

Fig. 54.

side lengths at the junction of chains. The discrepancies, referred to the seventh place of decimals in the logarithms, between the measured and computed base lengths, or between the lengths of sides at the junctions as computed by two

different routes, stand thus :

1. Dehra and Sironj bases . .  $AB$  . . . . . + 44, 0 ;
2. Triangle side at  $a$  . . . . .  $Ba - Ad, da$  . . + 68, 2 ;
3. Dehra and Chach bases . .  $BC$  . . . . . + 71, 9 ;
4. Sironj and Karachi bases .  $AD$  . . . . . - 79, 6 ;
5. Karachi and Chach bases .  $DC$  . . . . . + 163, 8 ;
6. Side at  $b$  . . . . .  $da, ab - de, eb$  . - 124, 6 ;
7. Side at  $c$  . . . . .  $hb, bc - hf, fc$  . + 150, 9 ;
8. Side at  $C$  . . . . .  $fc, cC - fg, gC$  . - 5, 3.

Next follow the discrepancies of latitude, longitude, and azimuth at  $a, b, g, c, C$  :

	$\Phi - \Phi'$	$\Omega - \Omega'$	$A - A'$
	"	"	"
$a \dots AB, Ba - Ad, da \dots$	+ 0.39	+ 0.17	+ 5.91 ;
$b \dots da, ab - de, eb \dots$	- 0.39	+ 0.21	+ 1.55 ;
$g \dots eh, hg - eD, Dg \dots$	+ 0.39	+ 0.29	- 3.25 ;
$c \dots hb, bc - hf, fc \dots$	+ 0.04	- 0.29	- 4.23 ;
$C \dots fc, cC - fg, gC \dots$	- 0.00	- 0.29	- 3.00.

These numbers supply the absolute terms of the 23 equations of condition. After the formation of these equations the next step is to form the equations for the 23 multipliers, and solve them numerically.

The values of the corrections, viz. the  $x$ 's and  $y$ 's resulting from this voluminous calculation, are remarkably small. The total number is 1650 ; of which 1511 are less than a tenth of a second, 116 are between  $0''.1$  and  $0''.2$ , 20 are between  $0''.2$  and  $0''.3$ , and 2 between  $0''.3$  and  $0''.4$  ; 1 only amounts to  $0''.46$ .

This is the merest sketch of the elaborate system of calculation followed in the reduction of the Indian triangulation ;

its brevity might convey the impression that the matter is simple; a reference however to General Walker's second volume will dispel such impression.

We have referred to the reduction of the north-west quadrilateral only, but similar methods are followed in the other sections of the work.

In the reduction by least squares of the triangulation of Spain<sup>1</sup>, it has been found necessary in order to solve the equations of condition—which are more than seven hundred in number—to divide the whole network into ten groups: the number of equations of condition in these groups being from 60 to 83. Each group is reduced independently of the adjacent groups, and finally certain equations of condition are introduced in order to reconcile discrepancies that must otherwise appear at the common lines of junction. The number of base lines is four.

#### 14.

The French have recently (1859–1869) executed in Algiers, with modern instruments and methods, a network of triangulation extending from the frontiers of Morocco to those of Tunis, embracing  $10^{\circ}$  of longitude. M. le Commandant Perrier who conducted the western half of this chain was one of the officers who, in 1861–62, acted in co-operation with the English in the connection of the triangulation of England with that of France—which connected in fact the Shetland with the Balearic Isles. In the course of a reconnaissance of the mountains near Oran in August, 1868, M. Perrier satisfied himself that it was possible to connect geodetically Algiers with the peaks of the Sierra Nevada, some sixty leagues distant in Andalusia. He observed in fact two of these peaks from several of his stations, determining their approximate distances and heights, and proving that the path of the ray of vision did not in any case come within 300 metres of the surface of the sea. The only remaining difficulty was to obtain a visible signal suitable for the purpose of strict geodetic observations.

<sup>1</sup> *Informe sobre la compensacion, por trozos, de los errores angulares de la Red geodésica de España.* Madrid, 1878.

By the co-operation of the French and Spanish officers, and the liberality of their respective governments, the junction has just (in the autumn of the present year, 1879) been completed in the most perfect manner by means of the electric light.

Twenty miles south-east of Granada is the highest peak in Spain—Mulhacen—11420 feet in height; distant fifty miles E. N. E. from this is Tetica (6820 ft.); the line joining these points forms one side of a quadrilateral of which the opposite side is in Algiers. The terminal points of the Algerian side, which is 66 miles in length, are Filhaoussen (3730 ft.) and M'Sabiha (1920 ft.), each of which is about 170 miles from Mulhacen. The other two sides and the diagonals of the quadrilateral span the Mediterranean. Each station observes the other three, so forming four triangles whose spherical excesses are

$$43''.50, \quad 60''.07, \quad 70''.73, \quad 54''.16.$$

At each station the signal light was produced by a steam engine of six horse-power working a Gramme's magneto-electric machine in connection with the apparatus of M. Serrin. The labour of transporting to such altitudes this machinery, with the requisite water and fuel—in addition to the ordinary geodetic instruments and equipment—and the maintenance of the whole in action for two months, necessitated at each station the formation of a military post. After incredible difficulties, the whole was ready on August 20th, the Spanish stations occupied by Colonel Barraquer and Major Lopez, the Algerian by M. le Commandant Perrier and Major Bassot. It was not however until the 9th of September that the electric light of Tetica was seen in Algiers—a red round star-like disk visible at times to the naked eye; on the following day Mulhacen was seen, and the observations were thenceforth prosecuted until the 18th of October. The errors of the sums of the observed angles in the four triangles were

$$+0''.18, \quad -0''.54, \quad +1''.84, \quad +1''.12,$$

leaving nothing to be desired on the score of precision. Thus

a continuous triangulation now extends from Shetland into Africa.

Not content with this brilliant achievement, the determination of the difference of longitudes of Tetica and M'Sabiha was resolved upon and carried out by M. Perrier and his Spanish associates. The method that should be adopted for this purpose had been previously made the subject of elaborate investigation and study at Paris with the apparatus actually used. The signals adopted were the eclipsing of the light every alternate second, the interval between the eclipse and the reappearance being one second. The signals numbering 640 each evening, divided into sixteen series, were issued alternately from Tetica and M'Sabiha from the 5th of October to the 16th of November; the observations being registered chronographically.

The difference of the personal errors of the observers, M.M. Perrier and Merino, had been thoroughly investigated at Paris, so that nothing was wanting to render the results absolutely satisfactory.

15.

We shall conclude this chapter by giving the formulæ for the solution of a simple quadrilateral with diagonals as in

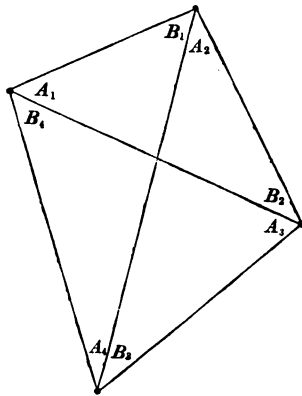

Fig. 55.

the annexed figure. Let the spherical excesses of the four

triangles with common vertex be  $\xi_1, \xi_2, \xi_3, \xi_4$ , then denoting by accents the observed values of the angles, the three angle-equations may be written thus

$$\begin{aligned} 360^\circ - \Sigma(A' + B') + \Sigma(\xi) &= e_0, \\ -A_1' - B_1' + A_3' + B_3' + \xi_1 - \xi_3 &= e_1, \\ -A_2' - B_2' + A_4' + B_4' + \xi_2 - \xi_4 &= e_2, \end{aligned}$$

where  $e_0, e_1, e_2$  result from the errors of observation. From these we have to form the quantities

$$\begin{aligned} \epsilon_1 &= \frac{1}{8} e_0 + \frac{1}{4} e_1, & \epsilon_2 &= \frac{1}{8} e_0 + \frac{1}{4} e_2, \\ \epsilon_3 &= \frac{1}{8} e_0 - \frac{1}{4} e_1, & \epsilon_4 &= \frac{1}{8} e_0 - \frac{1}{4} e_2. \end{aligned}$$

The eight unknown corrections to the eight observed angles (which we suppose to have been independently observed) may by means of the three angle-equations be reduced to five, and expressed thus :

$$\begin{aligned} \mathfrak{A}_1 &= A_1' + \epsilon_1 + x_0 - x_1, & \mathfrak{A}_2 &= A_2' + \epsilon_2 - x_0 - x_2, \\ \mathfrak{B}_1 &= B_1' + \epsilon_1 + x_0 + x_1, & \mathfrak{B}_2 &= B_2' + \epsilon_2 - x_0 + x_2, \\ \mathfrak{A}_3 &= A_3' + \epsilon_3 + x_0 - x_3, & \mathfrak{A}_4 &= A_4' + \epsilon_4 - x_0 - x_4, \\ \mathfrak{B}_3 &= B_3' + \epsilon_3 + x_0 + x_3, & \mathfrak{B}_4 &= B_4' + \epsilon_4 - x_0 + x_4; \end{aligned}$$

and it remains that these must fulfil the condition

$$\frac{\sin \mathfrak{A}_1 \sin \mathfrak{A}_2 \sin \mathfrak{A}_3 \sin \mathfrak{A}_4}{\sin \mathfrak{B}_1 \sin \mathfrak{B}_2 \sin \mathfrak{B}_3 \sin \mathfrak{B}_4} = 1.$$

If we put

$$\frac{\sin(A_1' + \epsilon_1) \sin(A_2' + \epsilon_2) \sin(A_3' + \epsilon_3) \sin(A_4' + \epsilon_4)}{\sin(B_1' + \epsilon_1) \sin(B_2' + \epsilon_2) \sin(B_3' + \epsilon_3) \sin(B_4' + \epsilon_4)} = 1 + \eta \sin 1'',$$

$$c_1 = \cot A_1 + \cot B_1, \quad c_1' = \cot A_1 - \cot B_1, \quad \&c.,$$

$$c_0 = -c_1' + c_2' - c_3' + c_4';$$

it follows that  $x_0, x_1, x_2, \dots$  being expressed in seconds,

$$\eta = c_0 x_0 + c_1 x_1 + c_2 x_2 + c_3 x_3 + c_4 x_4.$$

We shall suppose for simplicity that the angles have been observed with equal precision, then the condition that the sum of the squares of the corrections is a minimum leads to this result,

$$\frac{4x_0}{c_0} = \frac{x_1}{c_1} = \frac{x_2}{c_2} = \frac{x_3}{c_3} = \frac{x_4}{c_4} = \frac{\eta}{(c^2) + \frac{1}{4}c_0^2}.$$

As a numerical example of the application of this method take a quadrilateral corresponding in magnitude and in form with that we have described above as forming the junction of Europe and Africa. Let the observed angles be

$$\begin{array}{ll} A_1' = 50^\circ 25' 41''.24, & B_1' = 88^\circ 53' 30''.50, \\ A_2' = 24 10 2.12, & B_2' = 16 31 28.60, \\ A_3' = 79 1 35.00, & B_3' = 60 17 56.03, \\ A_4' = 17 57 10.36; & B_4' = 22 44 32.14. \end{array}$$

The values of  $\xi_1 + \xi_2$ ,  $\xi_2 + \xi_3$ ,  $\xi_3 + \xi_4$ ,  $\xi_4 + \xi_1$ , or the spherical excesses of the four large triangles, are—

$$43''.50, \quad 60''.07, \quad 70''.73, \quad 54''.16;$$

and the errors of the sums of the observed angles of the same triangles are respectively—

$$-1''.04, \quad +1''.68, \quad +2''.80, \quad +0''.08,$$

and we have

$$e_0 = -1''.76, \quad e_1 = +2''.72, \quad e_2 = +1''.12,$$

and

$$\begin{array}{lll} \epsilon_1 = +0.46, & c_1 = 0.846, & c_1' = +0.808, \\ \epsilon_2 = +0.06, & c_2 = 5.601, & c_2' = -1.143, \\ \epsilon_3 = -0.90, & c_3 = 0.764, & c_3' = -0.376, \\ \epsilon_4 = -0.50; & c_4 = 5.472; & c_4' = +0.702: \end{array}$$

also,  $c_0 = -0.873, \quad (c^2) = 62.613,$

and  $\log \{(c^2) + \frac{1}{4} c_0^2\}^{-1} \{\text{mod. } \sin 1''\}^{-1} = 3.87872.$

$\log \sin (A' + \epsilon)$	$\log \sin (B' + \epsilon)$
9.8869572,	9.9999188,
9.6121499,	9.4539715,
9.9919850,	9.9388298,
9.4888783,	9.5872441,
sum = 8.9799704,	8.9799642 = sum.

Hence,  $\eta \text{ mod. } \sin 1'' = +0.0000062,$  and then

$$\begin{array}{ll} & 3.8787, \\ \log \eta \text{ mod. } \sin 1'' & 4.7924, \\ \log \eta \{(c^2) + \frac{1}{4} c_0^2\}^{-1} & 8.6711; \end{array}$$

so that  $\eta \{(c^2) + \frac{1}{4} c_0^2\}^{-1} = +0''\cdot0469$ . The values of  $x_0, x_1, \dots$  follow at once:

$$\begin{aligned} x_0 &= -0\cdot010, \\ x_1 &= +0\cdot040, \\ x_2 &= +0\cdot263, \\ x_3 &= +0\cdot036, \\ x_4 &= +0\cdot257; \end{aligned}$$

and the resulting corrected angles are

$$\begin{array}{rcl} \alpha_1 & = & 50 \quad 25 \quad 41\cdot650, \\ \alpha_2 & = & 24 \quad 10 \quad 1\cdot927, \\ \alpha_3 & = & 79 \quad 1 \quad 34\cdot054, \\ \alpha_4 & = & 17 \quad 57 \quad 9\cdot613, \end{array} \quad \begin{array}{rcl} \beta_1 & = & 88 \quad 53 \quad 30\cdot990, \\ \beta_2 & = & 16 \quad 31 \quad 28\cdot933, \\ \beta_3 & = & 60 \quad 17 \quad 55\cdot156, \\ \beta_4 & = & 22 \quad 44 \quad 31\cdot907. \end{array}$$

## CHAPTER X.

### CALCULATION OF LATITUDES AND LONGITUDES.

#### 1.

THE problem:—Given the latitude of  $A$ , and the distance and azimuth of  $B$  from  $A$ , to determine the latitude and longitude of  $B$  and the azimuth of  $A$  at  $B$ , would be very simple if the earth were a sphere, requiring merely the solution of a single spherical triangle. But the calculation is not quite so simple on a spheroid. In the accompanying figure  $AN$  is the normal ( $=\rho$ ) at  $A$ ,  $NAB$  is the vertical plane at  $A$  passing through  $B$ , and the inclination of this plane to the meridian of  $A$  is the azimuth ( $=a$ ) of  $B$ . The inclination of the plane  $ANB$  to the meridian of  $B$ —call it  $\alpha$ ,—is not however the azimuth of  $A$  at  $B$ . This azimuth,  $\alpha'$ , is the inclination of the plane  $BMA$  to the meridian of  $B$ ,  $BM$  being the normal at  $B$ . Let  $\phi$ ,  $\phi'$ ,  $\omega$  be the latitudes and difference of longitudes of  $A$  and  $B$ , and let  $ANB = \theta$ ,  $BNO = \psi$ .

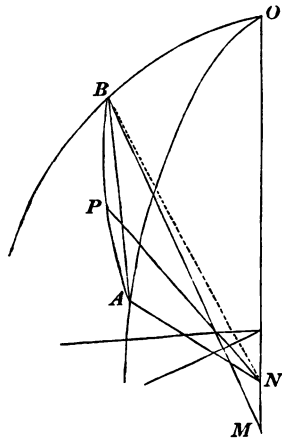

Fig. 56.

The difference of the angles  $\alpha$ , and  $\alpha'$  is a very small



quantity: it may be thus investigated. In the spherical triangle formed by the directions  $BA, BM, BN$

$$\frac{\sin a}{\sin a'} = \frac{\sin ABM}{\sin ABN} = \frac{NB}{NA} \cdot \frac{\sin ABM}{\sin BAN} = \frac{NB}{NA} \cdot \frac{\cos \mu'}{\cos \mu},$$

where  $\mu, \mu'$  have the same signification as at page 104. Now the equations (10), page 106, give  $\Delta' \sin \mu = \Delta \sin \mu'$ , and thence we get

$$\frac{\sin \mu'}{\sin \mu} = 1 - \frac{1}{2} e^2 \sin(\phi' - \phi) \sin(\phi' + \phi),$$

$$\frac{\cos \mu'}{\cos \mu} = 1 + \frac{1}{4} e^2 \theta^3 \cos a \sin \phi \cos \phi;$$

then, as we shall see in equation (2) following, the approximate value of  $NB : NA$  is

$$\frac{NB}{NA} = 1 - \frac{1}{2} \frac{e^2}{1 - e^2} (\sin \psi - \sin \phi)^2.$$

On substituting these in the expression for  $\sin a : \sin a'$ , there results, after some little reduction,

$$\begin{aligned} a' - a &= -\frac{\theta^2}{4} \frac{e^2}{1 - e^2} \cos^2 \phi \sin 2a + \frac{e^2 \theta^3}{8} \sin 2\phi \sin a, \\ &= -\frac{e^2 \omega (\phi' - \phi)}{2(1 - e^2)} \cos^3 \frac{1}{2} (\phi' + \phi). \end{aligned}$$

If  $LL'$  be the number of degrees in the differences of longitude and of latitude between  $A$  and  $B$ , and if the ratio of the semiaxes be 294 : 295,

$$a' - a = -0'' \cdot 21407 LL' \cos^3 \frac{1}{2} (\phi' + \phi), \quad (1)$$

so that only in long distances can this quantity be appreciable.

## 2.

We shall now investigate an expression for the angle subtended at  $N$  by a distance  $s$  measured along the plane section  $AB$ . Let  $AP = s$ ,  $ANP = \theta$ ,  $NP = r$ , and the angle  $PNO = 90^\circ - \psi$ , then

$$\sin \psi = \cos \theta \sin \phi + \sin \theta \cos \phi \cos a.$$

$C$  being the centre of the spheroid we know that

$$CN = e^2 \rho \sin \phi,$$

consequently

$$\frac{r^2 \cos^2 \psi}{a^2} + \frac{(r \sin \psi - e^2 \rho \sin \phi)^2}{c^2} = 1.$$

Multiply through by  $a^2 = \rho^2(1 - e^2 \sin^2 \phi)$ , and we get on rearranging the terms the following :

$$r^2 + \frac{e^2}{1 - e^2} (r \sin \psi - \rho \sin \phi)^2 - \rho^2 = 0. \tag{2}$$

Using  $f$  and  $h$  in the same sense as at page 107, and putting

$$\begin{aligned} f \cos \theta + h \sin \theta &= F, \\ -f \sin \theta + h \cos \theta &= H, \\ \frac{r}{\rho} &= U, \\ UF - f &= V, \end{aligned}$$

we get for the equation of the curve

$$U^2 + V^2 - 1 = 0, \tag{3}$$

which is easily seen to correspond with the equation (14), page 107, if we put this last in the form

$$(h \xi - f \zeta)^2 + (\rho - \zeta)^2 + \xi^2 - \rho^2 = 0.$$

Differentiate (3) successively with respect to  $\theta$ , and put  $U_m, V_m$  for the  $m^{\text{th}}$  differential coefficients of  $U, V$ : thus

$$\begin{aligned} 0 &= UU_1 + VV_1, \\ 0 &= UU_2 + U_1^2 + VV_2 + V_1^2, \\ 0 &= UU_3 + 3U_1U_2 + 3VV_3 + 3V_1V_2, \\ 0 &= UU_4 + 4U_1U_3 + 3U_2^2 + VV_4 + 4V_1V_3 + 3V_2^2, \\ &\quad \&c. ; \end{aligned}$$

and since  $\frac{dF}{d\theta} = H$ , and  $\frac{dH}{d\theta} = -F$ ,

$$\begin{aligned} V_1 &= U_1F + UH, \\ V_2 &= U_2F + 2U_1H - UF, \\ V_3 &= U_3F + 3U_2H - 3U_1F - UH, \\ V_4 &= U_4F + 4U_3H - 6U_2F - 4U_1H + UF, \\ &\quad \&c. \end{aligned}$$

We require the values of  $U, U_1, \dots, V, V_1, \dots$  when  $\theta = 0$ . Let these particular values be  $(U), (U_1), \dots, (V), (V_1), \dots$ , then  $(U) = 1$  and  $(V) = 0$ , and

$$\begin{aligned} 0 &= (U_1), \\ 0 &= (U_2) + (V_1)^2, \\ 0 &= (U_3) + 3(V_1)(V_2), \\ 0 &= (U_4) + 3(U_2)^2 + 4(V_1)(V_3) + 3(V_2)^2, \\ &\quad \&c.; \end{aligned}$$

$$\begin{aligned} (V_1) &= h, \\ (V_2) &= f(U_2) - f, \\ (V_3) &= f(U_3) + 3h(U_2) - h, \\ (V_4) &= f(U_4) + 4h(U_3) - 6f(U_2) + f, \\ &\quad \&c.; \end{aligned}$$

from which eliminating the  $V$ 's

$$\begin{aligned} (U_2) &= -h^2, \\ (U_3) &= 3fh(1+h^2), \\ (U_4) &= h^2(4+9h^2) - 3f^2(1+h^2)(1+5h^2); \end{aligned}$$

and finally, by Maclaurin's theorem,

$$\frac{r}{\rho} = 1 + \frac{(U_2)}{1.2} \theta^2 + \frac{(U_3)}{1.2.3} \theta^3 + \frac{(U_4)}{1.2.3.4} \theta^4 + \dots \quad (4)$$

Now if  $s$  be the length of the arc,

$$\frac{ds}{d\theta} = r + \frac{1}{2r} \left(\frac{dr}{d\theta}\right)^2 - \frac{1}{8r^3} \left(\frac{dr}{d\theta}\right)^4 + \dots,$$

from which we get, dropping the parenthesis,

$$\frac{ds}{d\theta} = \rho \left\{ 1 + (U_2 + U_2^2) \frac{\theta^2}{2} + (U_3 + 3U_2U_3) \frac{\theta^3}{6} + \dots \right\};$$

on integrating and reversing the series there results

$$\theta = \frac{s}{\rho} - \frac{U_2(1+U_2)}{1.2.3} \left(\frac{s}{\rho}\right)^3 - \frac{U_3(1+3U_2)}{1.2.3.4} \left(\frac{s}{\rho}\right)^4 + \dots \quad (5)$$

As far as this series goes it would appear that all the terms vanish except the first when  $\alpha = 90^\circ$ , but this is not the case, as the fourth term does not vanish—in fact, when  $\alpha = 90^\circ$ ,

$$\frac{s}{\rho} = \theta - \frac{e^2}{1-e^2} \sin^2 \phi \frac{\theta^5}{40},$$

or practically  $s = \rho \theta$ .

3.

The following numerical example is taken from the volume entitled *Extension of the Triangulation of Great Britain and Ireland into France and Belgium*. At page 253 we have the distance of Feaghmain from Greenwich and the angle at the latter point between Feaghmain and Chingford. Now the azimuth of Chingford is  $359^{\circ} 59' 58''.360$ , so that the value of  $a$  is  $81^{\circ} 59' 13''.497$ . The adopted latitude of Greenwich is  $51^{\circ} 28' 39''.864$  (resulting from a calculation which need not be here specified). The semiaxes adopted are

$$a = 20926348, \quad c = 20855233;$$

then if  $\sigma_1, \sigma_2, \sigma_3$  be the first, second, and third terms of (5) expressed in seconds,

$\log s$	6.37108677,	
$\log (\rho \sin 1'')^{-1}$	7.99282796,	
$\log \sigma_1$	4.36391473,	$\sigma_1 = 6^{\circ} 25' 16''.1088,$
		$\sigma_2 = \quad + .0025,$
		$\sigma_3 = \quad - .0019,$
		$\theta = 6^{\circ} 25' 16''.1094.$

Then we have to solve an ordinary spherical triangle, having given two sides  $\theta, 90^{\circ} - \phi$ , and the included angle  $a$ ; to find the other angles  $\alpha$ , and  $\omega$ ,

$\log \sec \frac{1}{2} (90^{\circ} - \phi + \theta)$	0.03429587,	$\log \operatorname{cosec}$	0.41767856,
$\log \cos \frac{1}{2} (90^{\circ} - \phi - \theta)$	9.98273156,	$\log \sin$	9.44167235,
$\log \cot \frac{1}{2} a$	0.06093582,	$\log \cot$	0.06093582,
$\log \tan \frac{1}{2} (a, + \omega)$	0.07796325,	$\log \tan$	9.92028673;

$\frac{1}{2} (a, + \omega)$	=	50	6	55.3757,
$a,$	=	89	53	11.1759,
$\frac{1}{2} (a, - \omega)$	=	39	46	15.8002,
$\omega$	=	10	20	39.5755;

the small correction  $a' - a$ , amounts in this case to  $-0''.2319$ . Thus we have  $a'$ .

The third side of the same spherical triangle, namely that opposite to Greenwich, is easily found to be

$$90^{\circ} - \psi = 38^{\circ} 4' 42''.2145.$$

Then by (5), since  $\psi - \phi$  is only a few minutes,  $\rho(\psi - \phi)$  is the distance of the parallels of Greenwich and Feaghmain; and this distance divided by the radius of curvature for the approximate mean of the latitudes of the two stations gives their actual difference of latitude.

## 4.

Returning to the general question, let us take first the case in which the value of  $a$  is a right angle, and  $s$  not greatly exceeding, say, a degree. The azimuth  $a'$  in this case will not differ from  $a$ , by any perceptible quantity; put

$$a' = 90^\circ - \nu;$$

here  $\nu$  is called the 'convergence of meridians.'

Take a point  $B'$  on the meridian of  $A$  in the same latitude as  $B$ , so that the angle  $B'NO = BNO$ , and let  $B'NA = \eta$ , then by (21), page 45,

$$\eta = \frac{1}{2} \left( \frac{s}{\rho} \right)^2 \tan \phi,$$

and  $\rho$  being the radius of curvature of the meridian at  $A$ ,

$$\phi - \phi' = \rho \eta : \rho.$$

Thus we have, referring again to the equations (21),

$$\phi - \phi' = \frac{1}{2} \frac{s^2}{\rho} \tan \phi, \quad (6)$$

$$\omega = \frac{s}{\rho \cos(\phi - \frac{2}{3}\eta)},$$

$$\nu = \omega \sin(\phi - \frac{1}{3}\eta).$$

These three equations complete the solution of this case. It will simplify matters if we avoid the reduction of  $\eta$  to  $\phi - \phi'$ . This we may do by at once computing

$$\phi - \phi' = \frac{s^2}{2\rho} \tan \phi = \eta; \quad (7)$$

for the error thus introduced into the last two equations of (6) is of the order  $e^2 s^3$ , and it is easy to convince oneself by a short calculation that for the distances we are contemplating

this may be neglected. The errors of these values of  $\omega$  and  $\nu$  are in fact

$$\begin{aligned} \partial \omega &= -\frac{2}{3} e^2 \eta \left(\frac{s}{\rho}\right) \sin \phi, \\ \partial \nu &= -\frac{1}{3} e^2 \eta \left(\frac{s}{\rho}\right) (1 + \sin^2 \phi). \end{aligned}$$

From the results just arrived at we can at once solve the more general problem when  $a$  has any value whatever. From  $B$  draw a perpendicular to the meridian of  $A$  meeting it in  $P$ , and let the spherical excess of the triangle  $ABP$  be  $\epsilon$ , then

$$AP = s \cos \left(a - \frac{2}{3} \epsilon\right), \quad BP = s \sin \left(a - \frac{1}{3} \epsilon\right).$$

Let the latitude of  $P$  be  $\phi_1$ , the radius of curvature for the latitude  $\frac{1}{2}(\phi + \phi_1)$  being  $\rho_0$ : let also the difference of latitude  $\phi_1 - \phi' = \eta$ , then

$$\begin{aligned} \epsilon &= \frac{s^2}{2 \rho} \sin a \cos a, \\ \eta &= \frac{s^2}{2 \rho} \sin^2 a \tan \phi_1, \\ \phi' - \phi &= \frac{s}{\rho_0} \cos \left(a - \frac{2}{3} \epsilon\right) - \eta, \\ \omega &= \frac{s \sin \left(a - \frac{1}{3} \epsilon\right)}{\rho \cos \left(\phi' + \frac{1}{3} \eta\right)}, \\ \nu &= \omega \sin \left(\phi' + \frac{2}{3} \eta\right) - \epsilon. \end{aligned} \tag{8}$$

Here  $\rho$  and  $\rho_0$  correspond to  $P$ , that is to latitude  $\phi_1$ . It is to be remembered that in this calculation  $\epsilon$  is negative when  $\cos a$  is negative. With respect to the last equation expressing the convergence, the angle at  $B$  between  $A$  and  $P$  is equal to  $90^\circ - a + \epsilon$ , and the azimuth of  $P$  at  $B$  is

$$90^\circ - \omega \sin \left(\phi_1 - \frac{1}{3} \eta\right);$$

thus the azimuth of  $A$  at  $B$  being the sum of these is

$$180^\circ - a - \nu.$$

### 5.

We shall now give a numerical example of the application of these formulæ, and for this purpose shall select the shorter

274 CALCULATION OF LATITUDES AND LONGITUDES.

side of the spheroidal triangle, of which we have at page 110 the exact elements. We require the following table:—

$$a = 20926060, \quad a : c = 295 : 294.$$

$\phi$	$\text{Log} \frac{1}{\rho \sin 1''} + 10.$	$\text{Log} \frac{1}{\rho \sin 1''} + 10.$	$\text{Log} \frac{1}{2 \rho \sin 1''} + 10.$
51 50	7.9928272927	7.9939559152	0.371326
52 0	8231241	9434094	311
10	8189614	9309214	295
20	8148048	9184517	278
30	7.9928106545	7.9939060007	0.371262
40	8065106	8935689	245
50	8023732	8811567	228
53 0	7982424	8687645	212
10	7.9927941185	7.9938563927	0.371195

The data for the calculation are

$$s = 436481.4,$$

$$a = 20^\circ 39' 17''.240,$$

$$\phi = 51 57 0.000.$$

It is necessary first to calculate an approximate value of  $\phi$ , by means of the formula

$$\phi_1 - \phi = \frac{s}{\rho_0} \cos a,$$

the result is  $\phi_1 = 53^\circ 4' 8''$ . Then putting  $E^{-1}$  for  $2 \rho \sin 1''$ , the calculation will stand thus:

$\log s^2$	11.27994		
$\log \sin a$	9.54745	$\alpha - \frac{1}{3}\epsilon = 20 39 12.313$	
$\log \cos a$	9.97115	$\alpha - \frac{2}{3}\epsilon = 20 39 7.386$	
$\log E$	0.37120		
$\epsilon = 14''.782$	1.16974	$\log s$	5.6399657
$\log \tan a$	9.57630	$\log \cos (\alpha - \frac{2}{3}\epsilon)$	9.9711550
$\log \tan \phi_1$	0.12397	$\log (\rho \sin 1'')^{-1}$	7.9939053
$\eta = 7''.413$	0.87001	4027''.411	3.6050260
$\log s$	5.6399657	$\phi' - \phi = 1 6 59.998$	
$\log \sin (\alpha - \frac{1}{3}\epsilon)$	9.5474230	$\phi' = 53 3 59.998$	
$\log (\rho \sin 1'')^{-1}$	7.9927965		
$\log \sec (\phi' + \frac{1}{3}\eta)$	0.2212153	$\phi' + \frac{1}{3}\eta = 53 4 2.469$	
2520''.000	3.4014005	$\omega = 0 42 0.000$	
$\log \sin (\phi' + \frac{2}{3}\eta)$	9.9027368	$\phi' + \frac{2}{3}\eta = 53 4 4.940$	
2014''.361	3.3041373	$\nu = 0 33 19.579$	

Thus we have the azimuth of  $A$  at  $B$   $158^{\circ} 47' 23''.181$ ; it should be  $158^{\circ} 47' 23''.182$ . And the errors of latitude, longitude, and azimuth are

$$\partial\phi' = -0''.002, \quad \partial\omega = 0''.000, \quad \partial a' = 0''.001.$$

6.

In the case of distances exceeding a hundred miles it may be necessary to proceed in the following manner. The angle  $\theta$  can be obtained with any degree of accuracy that may be required from the series already investigated, then by a simple application of the rules of spherical trigonometry we have  $a$ ,  $\psi$ , and  $\omega$ , with any accuracy that may be required— $a'$  following from  $a$ , as we have seen by a very small and easily calculated correction. With respect to  $\phi'$ , the latitude of  $B$ , the only direct expression for it is obtained thus: join  $B$  with the centre of the spheroid and let  $\lambda$  be the geocentric latitude of  $B$ , then if  $BN = r$ ,

$$\frac{\tan \lambda}{\tan \psi} = \frac{r \sin \psi - e^2 \rho \sin \phi}{r \sin \psi},$$

but  $\tan \lambda = (1 - e^2) \tan \phi'$ , therefore

$$(1 - e^2) \frac{\tan \phi'}{\tan \psi} = 1 - e^2 \frac{\rho \sin \phi}{r \sin \psi}, \tag{9}$$

and a very approximate value of  $\rho : r$  may be written down at once from (2). Still, the formula (9) is inconvenient for actual calculation, and it is practically easier to find the distance of the parallels of the two stations and then to divide this distance by the radius of curvature at the mid-latitude.

Let  $S$  be the distance of the parallels of  $A$  and  $B$ , then from the expression (5) for  $\theta$  in terms of  $s$  it is easy to show that

$$\frac{S}{s} = \frac{\psi - \phi}{\theta}. \tag{10}$$

To be very precise,  $+\frac{1}{4}e^2\theta^3\sin^2 2a\sin 2\phi$  should be added on the right side of this equation, but it may be safely neglected as in all cases quite evanescent: therefore by equation (22), page 45, it follows that

$$S = s \frac{\sin \frac{1}{2}(a, -a)}{\sin \frac{1}{2}(a, +a)} \left\{ 1 + \frac{\theta^2}{12} \cos^2 \frac{1}{2}(a, -a) \right\}. \tag{11}$$



## 7.

In the calculations we have been exemplifying, the results depend on the elements assumed for the figure of the earth; but it is often necessary to get results not so limited, and which can be readily modified to any change of the elements. Starting from the point  $A$  with a given latitude  $\phi$  and azimuth  $a$ , we compute, with numerical values  $a, e$ , the latitude and longitude and direction of the meridian at  $B$ ; let  $(\phi')$ ,  $(\omega)$ ,  $(a')$  be these results. Had we used  $a + \delta a$ ,  $e + \delta e$ , we should have obtained results of the form

$$\begin{aligned}(\phi') + h\delta a + h'\delta e, \\ (\omega) + j\delta a + j'\delta e, \\ (a') + k\delta a + k'\delta e.\end{aligned}$$

If then it were subsequently necessary to pass from  $B$  to a third point  $C$ , and obtain the latitude, longitude, and direction of the meridian there with the altered spheroidal elements, we have to take into account in so doing not only the variations  $\delta a$ ,  $\delta e$ , but the variations of latitude, longitude, and azimuth which have been already introduced at  $B$ . It is necessary therefore to consider this more general question: required the increments to the latitude, longitude, and direction of the meridian at  $B$ , when the latitude of  $A$  and the azimuth there of  $B$  receive increments  $\delta\phi$ ,  $\delta a$ , the elements of the spheroid at the same time being changed from  $a, e$  to  $a + \delta a, e + \delta e$ .

In solving the spherical triangle  $ABO$ , having given the angle at  $A$  and the containing sides, the variations of  $a$  and  $e$  cause a variation in  $\theta$ , for approximately

$$\theta = \frac{s}{a} (1 - e^2 \sin^2 \phi)^{\frac{1}{2}},$$

and

$$-\delta\theta = \theta \frac{\delta a}{a} + \frac{e\theta \sin^2 \phi}{1 - e^2 \sin^2 \phi} \delta e. \quad (12)$$

This supposes the distance  $s$  to be not excessively great. If it should greatly exceed the longest lines of observation in ordinary triangles a nearer approximation to  $\theta$  must be adopted, and there is no difficulty in supplying the corresponding term in  $\delta\theta$ , but to simplify our formulæ this case

is not considered here. In applying to the triangle  $ABO$  the formulæ, page 43, we shall introduce the convention that azimuths are measured from north by east from  $0^\circ$  to  $360^\circ$ , thus  $360^\circ - a'$  is the third angle of the triangle, viz. that at  $B$ ; also it is unnecessary to retain the distinction between  $a'$  and  $a$ ,. Longitudes are to be considered positive towards the east. Thus

$$\begin{aligned} \cos \psi \delta a' &= \sin \omega \delta \phi + \cos \phi \cos \omega \delta a - \sin \psi \sin a' \delta \theta, \\ \cos \psi \delta \omega &= \sin \psi \sin \omega \delta \phi - \sin \theta \cos a' \delta a - \sin a' \delta \theta, \quad (13) \\ \delta \psi &= \cos \omega \delta \phi + \sin \theta \sin a' \delta a - \cos a' \delta \theta. \end{aligned}$$

In the first two of these equations  $\psi$  may be replaced by  $\phi'$ , and in the third  $\sin \theta \sin a'$  may be replaced by  $-\cos \phi \sin \omega$ . In order to determine  $\delta \phi'$  we must revert to (9), putting it in the form

$$\tan \phi' = \tan \psi + \frac{e^2}{1-e^2} \cdot \frac{\Theta}{\cos \psi} - \frac{1}{2} \left( \frac{e^2}{1-e^2} \right)^2 \Theta^2 \tan \psi + \dots,$$

where  $\Theta$  is put for  $\sin \psi - \sin \phi$ . Differentiating this and omitting the last term, which is very small,

$$\begin{aligned} \sec^2 \phi' \delta \phi' &= \frac{1-e^2 \sin \phi \sin \psi}{(1-e^2) \cos^2 \psi} \delta \psi - \frac{e^2 \cos \phi}{1-e^2 \cos \psi} \delta \phi \\ &\quad + \frac{\Theta}{\cos \psi} \cdot \frac{2e \delta e}{(1-e^2)^2}, \end{aligned}$$

or with sufficient approximation

$$\delta \phi' = (1 + e^2 \cos^2 \phi) \delta \psi - e^2 \cos^2 \phi \delta \phi + \Theta \cos \psi \frac{2e \delta e}{(1-e^2)^2}.$$

Put for brevity  $1 + e^2 \cos^2 \phi = n$ , then the third of equations (13) gives

$$\delta \phi' = \cos \omega \delta \phi - n \sin \omega \cos \phi \delta a - n \cos a' \delta \theta + \frac{2 \Theta \cos \psi e \delta e}{(1-e^2)^2}.$$

If then  $\phi'$ ,  $\omega$ ,  $a'$  are the same functions of  $\phi + \delta \phi$ ,  $a + \delta a$ ,  $a + \delta a$ ,  $e + \delta e$  that  $(\phi')$ ,  $(\omega)$ ,  $(a')$  are of  $\phi$ ,  $a$ ,  $a$ ,  $e$ , we have finally equations (14) which are of great importance:

$$\begin{aligned} \phi' - (\phi') &= \cos \omega \delta \phi - n \sin \omega \cos \phi \delta a - n \cos a' \delta \theta + \frac{2 \Theta \cos \psi e \delta e}{(1-e^2)^2} \\ \cos \phi' \{ \omega - (\omega) \} &= \sin \phi' \sin \omega \delta \phi - \sin \theta \cos a' \delta a - \sin a' \delta \theta \\ \cos \phi' \{ a' - (a') \} &= \sin \omega \delta \phi + \cos \phi \cos \omega \delta a - \sin \phi' \sin a' \delta \theta. \end{aligned}$$

If  $\delta \phi = 0$  and  $\delta a = 0$ , then, eliminating  $\delta \theta$ ,

$$\phi' - (\phi') = \theta \cos a' n \frac{\delta a}{a} + \theta \cos a' \left\{ \frac{\sin^2 \phi}{1-e^2} - \frac{2 \cos^2 \phi}{(1-e^2)^2} \right\} e \delta e,$$

where it is to be remarked that the coefficient of  $\delta e$  vanishes when  $(3-e^2)\sin^2\phi = 2$ ; this condition exists in the vicinity of  $55^\circ$  latitude, nearly in the centre of Great Britain. Measurements in these latitudes therefore have in themselves no weight in the determination of the eccentricity.

It is to be remembered that in equations (13),  $\delta\theta$  involves not only  $\delta a$  and  $\delta e$  but also  $\delta\phi$ . The coefficient however of  $\delta\phi$  here is very small and may generally be omitted.

By differentiating (10) we find without any trouble the expression for  $\delta S$  in terms of  $\delta a$ ,  $\delta e$ ,  $\delta\phi$ ,  $\delta\alpha$ . For instance, taking into consideration only  $\delta a$  and  $\delta e$ ,

$$-\delta S = a \sin 2\phi \sin^2 \frac{\omega}{2} \cdot \frac{\delta\theta}{\theta}.$$

### 8.

The calculation at page 271 was originally made with the view of determining the length of the parallel of  $52^\circ$  contained between the meridians of Greenwich and Feaghmain. Let  $\rho'$  be the normal corresponding to the latitude of  $52^\circ$ , then the length of the arc of parallel is  $P = \rho' \omega \sin 1'' \cos 52^\circ$ ,  $\omega$  being =  $37239''.5755$  as we have seen, then

$$\begin{array}{ll} \log 37239''.5755 & 4.57100472, \\ \log \rho' \sin 1'' \cos 52^\circ & 1.79652713, \\ \log 230944.07 & 6.36753185. \end{array}$$

This value of  $P$  is however dependent on the particular elements assumed for the figure of the earth: increments  $\delta a$ ,  $\delta b$  to the semi-axes will produce an increment of the form  $\gamma\delta a + \gamma'\delta b$  to be added to the length of parallel just obtained. We have

$$\rho^2 = \frac{a^4}{a^2 \cos^2 \phi + b^2 \sin^2 \phi};$$

and taking the logarithmic differential, we get without much trouble

$$\frac{\delta\rho}{\rho} = \frac{\delta a}{a} \left(2 - \frac{\rho^2}{a^2} \cos^2 \phi\right) - \frac{\delta b}{b} \left(1 - \frac{\rho^2}{a^2} \cos^2 \phi\right),$$

which we shall write thus

$$\frac{\delta\rho}{\rho} = h\delta a + k\delta b.$$

Similarly,  $\rho'$  corresponding to  $\phi = 52^\circ$ , let

$$\frac{\delta \rho'}{\rho'} = h' \delta a + k' \delta b,$$

then 
$$\frac{\delta P}{P} = \frac{\delta \omega}{\omega} + \frac{\delta \rho'}{\rho'}.$$

Now the latitude of Greenwich in this case has itself to receive an increment  $\delta \phi = h, \delta a + k, \delta b$ , so that putting

$$\delta \theta = -\theta \frac{\delta \rho}{\rho} \quad \text{and} \quad \delta a = 0,$$

the second of equations (13) gives

$$\frac{\delta \omega}{\omega} = \tan \psi \frac{\sin \omega}{\omega} (h, \delta a + k, \delta b) + \frac{\theta}{\omega} \sin a' \sec \psi \frac{\delta \rho}{\rho}.$$

Thus we get

$$\begin{aligned} \frac{\delta P}{P} = \delta a \left( h, \tan \psi \frac{\sin \omega}{\omega} + h \frac{\theta}{\omega} \sin a' \sec \psi + h' \right) \\ + \delta b \left( k, \tan \psi \frac{\sin \omega}{\omega} + k \frac{\theta}{\omega} \sin a' \sec \psi + k' \right). \end{aligned}$$

And finally; the length of the arc of parallel in latitude  $52^\circ$  between Greenwich and Feaghmain, the semiaxes of the earth being  $20926348 + \delta a$  and  $20855233 + \delta b$  feet, is

$$2330944^{\text{ft.}}.07 + 0.0062 \delta a - 0.0006 \delta b.$$

So also for Greenwich and Mount Kemmel in Belgium, the length of the arc of parallel in  $52^\circ$  is

$$634157^{\text{ft.}}.39 + 0.0027 \delta a - 0.0006 \delta b.$$

## CHAPTER XI.

### HEIGHTS OF STATIONS.

THE direction in which a signal  $B$  is seen at an observing point  $A$  is determined by the direction of the tangent at  $A$  to the path of the ray of light passing between  $A$  and  $B$ . This direction differs from that of the straight line joining  $A$  and  $B$  on account of terrestrial refraction. The displacement, resulting from refraction, of the direction of  $B$ , takes place almost wholly in the vertical plane which we may with sufficient accuracy consider common to  $A$  and  $B$ . Lateral refraction sometimes exists, affecting to a very small extent horizontal angles, but we here are concerned only with the more ordinary phenomenon which affects the measurement of zenith distances. For the theory of this refraction we may refer to some able papers by Dr. Bauernfeind in the *Astronomische Nachrichten* for 1866. The amount of terrestrial refraction is very variable and not to be expressed by any simple law: the path of a ray of light, inasmuch as it depends on the refractive power of the atmosphere at every point through which it passes, is necessarily very irregular. This irregularity is very marked when the stations are low and the ray grazes the surface of the ground. In the plains of India it has been observed that the ground intervening between the observer and the distant signal, from being apparently convex in the early part of the day, changes gradually its appearance as the day advances, to a concavity—so that at sunset the ground seems to slope up to the base of the signal tower which in the early morning was entirely below the

horizon<sup>1</sup>. Under such conditions refraction is often negative: the coefficients ranging from  $-0.09$  to  $+1.21$ .

In Great Britain the refraction is greatest in the early mornings; towards the middle of the day it decreases, again to increase in the evenings—but this rule is not without remarkable exceptions. From a series of carefully conducted observations by Colonel Hossard at Angouleme<sup>2</sup> it appeared that refraction is greatest about daybreak; from 5 or 6 A.M. until 8 A.M. it diminishes very rapidly; from 8 A.M. until 10 A.M. the diminution is slow; from this hour until 4 P.M. refraction remains nearly constant; after that it commences to increase.

The average amount of refraction, by which is meant the difference between the true and the apparent directions, varies from about a twelfth to a sixteenth of the angle subtended by the stations at the centre of the earth. The larger values are found generally on the seaboard, the smaller values remote from the sea. The amount of refraction may be determined thus: let  $h, h'$  be the known heights of two stations  $A, B$ —obtained for instance by spirit levelling: at  $A$  let  $Z$  be the true zenith distance of  $B$ , and at  $B$  let  $Z'$  be the true zenith distance of  $A$ ,  $C$  being the centre of the earth, which we may suppose a sphere of radius  $r$ , let the angle  $ACB = v$ , then in the triangle  $ACB$

$$\begin{aligned} \frac{1}{2}(Z' + Z) &= 90^\circ + \frac{1}{2}v, \\ \tan \frac{v}{2} \tan \frac{1}{2}(Z' - Z) &= \frac{h' - h}{h' + 2r + h}, \end{aligned}$$

which determines  $Z$  and  $Z'$ . If we substitute for  $\tan \frac{1}{2}v$  the first two terms of its expansion in series, the second equation is easily put in the form

$$h' - h = s \tan \frac{1}{2}(Z' - Z) \left( 1 + \frac{h + h'}{2r} + \frac{s^2}{12r^2} \right), \quad (1)$$

where  $s$  is the distance of the stations  $A, B$  measured on the sea-level. The assumption that the earth is a sphere may be practically remedied by using the measure of curvature of the surface in the vicinity of the stations for  $1 : r^2$ .

<sup>1</sup> *Account of the Great Trigonometrical Survey of India*, vol. ii, page 77.

<sup>2</sup> *Mém. de Dépôt Gén. de la Guerre*, vol. ix, p. 451.

The coefficient of refraction is the ratio of the difference between the observed and real zenith distance at either station to the angle  $v$ : thus  $k$  being the coefficient of refraction,  $z, z'$  the observed zenith distances,

$$k = \frac{Z-z}{v} \quad \text{or} \quad k = \frac{Z'-z'}{v}.$$

These two values however do not always agree. The following table contains some determinations—selected at random—of the value of  $k$  obtained in this manner from observations made on the Ordnance Survey:—

STATION.	HEIGHT.	Z, Z'	z, z'	No. Obs.	v	k
	ft.	° ' "	° ' "		"	
Ben Lomond	3192.2	90 1 21.2	89 58 35.8	5	} 2300.7	-0.719
Ben Nevis ...	4406.3	90 37 2.0	90 33 25.3	19		-0.942
Dunkerry ...	1706.4	90 31 51.0	90 26 56.1	4	} 3870.9	-0.762
Precelly ...	1757.9	90 32 45.0	90 27 44.4	5		-0.777
High Wilhays	2039.6	90 42 22.7	90 36 14.3	14	} 4843.0	-0.761
Precelly ...	1757.9	90 38 26.7	90 31 36.4	6		-0.847
High Wilhays	2039.6	90 33 51.8	90 31 32.8	12	} 2142.9	-0.649
Hensbarrow	1027.0	90 1 54.0	89 59 20.1	17		-0.718
Coringdon ...	655.6	90 12 54.0	90 10 30.4	16	} 1806.9	-0.795
Dunnose ...	771.9	90 17 15.4	90 14 57.1	12		-0.765
Trevoze Head	242.6	90 3 18.2	90 1 5.6	20	} 1713.7	-0.774
Karnminnis	799.8	90 25 17.8	90 23 9.5	10		-0.749

The most abnormal coefficient here shown is that at Ben Nevis, and it is worthy of notice that for a fortnight—when the greater part of the observations were made—the state of the atmosphere at the top of the hill was most unusually calm, so much so, that a lighted candle could often be carried from the tents of the men to the observatory, whilst at the foot of the hill the weather was wild and stormy.

The value of the coefficient of refraction may also be obtained from the reciprocally observed zenith distances of  $A$  and  $B$ , independently of the knowledge of the heights of those stations. For assuming the refraction to be the same at both

stations (and for this end the observations should be simultaneous)  $Z = z + kv$  and  $Z' = z' + kv$ , therefore

$$z + z' + 2kv = 180^\circ + v;$$

$$\therefore 1 - 2k = \frac{z + z' - 180^\circ}{v}.$$

From the mean of 144 values of  $k$  determined from the observations of the Ordnance Survey it appears that the mean coefficient of refraction is .0771. If we arrange the different values in order of magnitude, the extremes are .0320 and .1058, while the 72 which hold the central position are contained between .0733 and .0804, the mean of these 72, viz. .0768 differing but little from the general mean. Thus it would appear that the probable error of a single determination of  $k$  is about  $\pm .0035$ .

But it is necessary to discriminate between rays which cross the sea and those which do not. The result, having regard to the weights of the single determinations, is finally this—

$$\begin{aligned} \text{for rays not crossing the sea, } k &= .0750; \\ \text{for rays crossing the sea, } k &= .0809; \end{aligned}$$

a result which is borne out by observations in other parts of the world; for instance<sup>1</sup>, in the Survey of Massachusetts the value of  $k$  adopted for the sea coast is .0784, while for the interior it is .0697.

From the preceding equations we get  $\frac{1}{2}(Z' - Z) =$

$$\frac{1}{2}(z' - z) = 90^\circ - z + v(\frac{1}{2} - k).$$

Let  $z$ , the observed zenith distance of  $B$  at  $A$ , be replaced by  $90^\circ + \delta$ , so that  $\delta$  is the 'depression' of  $B$ , then (1) becomes

$$k' - k = s \tan \left( s \frac{1 - 2k}{2r} - \delta \right) \left( 1 + \frac{h + k'}{2r} + \frac{s^2}{12r^2} \right), \quad (2)$$

or if we have also the depression  $\delta'$  of  $A$  as observed at  $B$

$$k' - k = s \tan \frac{1}{2}(\delta' - \delta) \left( 1 + \frac{h + k'}{2r} + \frac{s^2}{12r^2} \right). \quad (3)$$

The last factor in the last two equations may be safely omitted.

<sup>1</sup> *Professional Papers of the Corps of Engineers U.S.A.*, No. 12, page 143.



If further we consider only the cases of distant stations when  $\delta$  seldom exceeds a degree, we may put

$$h' - h = s^2 \left( \frac{1 - 2k}{2r} \right) - s\delta. \quad (4)$$

Put  $\mu = \frac{2r}{1 - 2k}$ , then taking the earth as a sphere of mean radius such that  $\log r = 7.32020$ ,

$$\begin{aligned} \text{for } k = .0750, & \quad \log \mu = 7.69181, \\ k = .0809, & \quad \log \mu = 7.69788, \end{aligned}$$

which suffice for ordinary purposes.

When the height  $h'$  of  $B$  has been determined from its observed zenith distance at  $A$  by the formula (4), the error of  $h'$  is

$$dh' = -\frac{s^2}{r} dk - s d\delta.$$

Suppose the distance  $s$  to be  $n$  miles, the probable error of the observed zenith distance  $\pm \epsilon$  seconds, that of the coefficient of refraction  $\pm .004$ , then the probable error, expressed in feet, of  $h'$  will be approximately

$$\pm \frac{n}{40} \left\{ \epsilon^2 + \left( \frac{n}{5} \right)^2 \right\}^{\frac{1}{2}}.$$

When the observations at  $A$  and  $B$  are mutual, we may either eliminate the coefficient of refraction by using the formula (3), or we may get two different results from a mean assumed value of  $k$ , and then combine these results by assigning them weights deduced from the consistency of the observations from which they are separately derived: the reciprocal of such weight according to the formula just given will be  $\epsilon^2 + \frac{1}{5} n^2$ .

When at each of three stations we have the observed zenith distances of the other two, the deduced differences of height will exhibit a discrepancy. Let the computed differences of height be  $C - B = h_1$ ,  $B - A = h_2$ ,  $A - C = h_3$ , then we ought to have  $h_1 + h_2 + h_3 = 0$ . This will not generally be the case, and we must apply corrections  $x_1, x_2, x_3$  to these quantities, such that

$$x_1 + x_2 + x_3 + h_1 + h_2 + h_3 = 0,$$

and if  $w_1, w_2, w_3$  be the weights of the determinations of  $h_1, h_2, h_3$  the quantity

$$w_1 x_1^2 + w_2 x_2^2 + w_3 x_3^2$$

must be a minimum: a case analogous to that of getting the corrections to the angles of a single triangle. Or we may proceed thus: suppose there are four points, mutually observing one another. Referring the heights to that of any one of the points, let them be 0,  $x$ ,  $y$ ,  $z$ , then we have six equations—

$$\begin{aligned} x + a &= 0, \\ y - x + a' &= 0, \\ y + b &= 0, \\ z - y + b' &= 0, \\ z + c &= 0, \\ x - z + c' &= 0, \end{aligned}$$

with assignable weights, from which  $x$ ,  $y$ ,  $z$  are to be obtained by least squares.

The principal lines of spirit levelling covering England and Wales were reduced in this manner: the number of unknown quantities being ninety-one. In the reduction of the levelling of Scotland there were seventy-seven unknown quantities.

Suppose that at a station of height  $h$ , the horizon of the sea is observed to have a depression  $\Delta$ , if its distance be  $\Sigma$ , equations (3) and (4) give

$$h = \Sigma \tan \frac{1}{2} \Delta, \quad h = \Sigma^2 \frac{1}{\mu};$$

and eliminating  $\Sigma$ ,  $h$  and  $\Delta$  are thus connected,

$$h = \mu \tan^2 \frac{1}{2} \Delta. \tag{5}$$

Let  $h'$ ,  $h''$  be the heights of two stations  $A$ ,  $B$ , whose distance apart is  $c$ ,  $\delta$  the depression of  $B$  as observed at  $A$ . Let  $C$  be any other point in the ray joining  $AB$ : for instance,  $C$  may be a signal which appears to be exactly in line with  $B$ . Let  $h$  be the height of  $C$ ,  $s + \frac{1}{2}c$ ,  $s - \frac{1}{2}c$  its distance from  $A$  and  $B$  respectively, then we have these three equations:

$$\begin{aligned} h - h' &= \frac{(s + \frac{1}{2}c)^2}{\mu} - (s + \frac{1}{2}c) \delta, \\ h'' - h' &= \frac{c^2}{\mu} - c \delta, \\ h - \frac{1}{2}(h' + h'') &= \frac{s}{c}(h'' - h') + \frac{1}{\mu}(s^2 - \frac{c^2}{4}), \end{aligned}$$

of which the third, obtained by eliminating  $\delta$  from the first two, is the equation to the path of the ray of light joining  $AB$ . The point at which this ray approaches nearest the surface is determined by making the differential coefficient of  $h$  with respect to  $s$  zero; thus we get

$$s_0 = -\frac{1}{2}(h'' - h') \frac{\mu}{c},$$

$$h_0 = h' - \frac{(s_0 + \frac{1}{2}c)^2}{\mu} = h'' - \frac{(s_0 - \frac{1}{2}c)^2}{\mu},$$

where  $s_0$  determines the place of the minimum height of the ray and  $h_0$  its amount. If we take for instance the case of Precelly in Pembrokeshire and High Wilhays in Devonshire, whose heights are given in the table, page 282, and which are 93 miles apart ( $\log c = 5.69221$ ) we find the minimum height of 677 ft. occurring at about 44 miles from the lower and 49 from the higher station.

So for the stations Tetica and M'Sabiha, page 262, whose mutual distance is 225.6 kilometres, the nearest approach of the visual ray to the surface of the Mediterranean is 1077 ft.

Two stations whose heights in feet are  $h'$ ,  $h''$  will not under ordinary circumstances be mutually visible over the surface of the sea, if their distance in miles exceeds

$$\frac{4}{3}(\sqrt{h'} + \sqrt{h''}).$$

## CHAPTER XII.

### CONNECTION OF GEODETIC AND ASTRONOMICAL OPERATIONS.

#### 1.

THEORETICAL considerations, as we have seen in chapter IV, combined with observation and measurement, have shown that the figure of the earth is very closely represented by an ellipsoid of revolution. It is not however exactly so; the visible irregularities of the external surface and the variations of density of the material composing the crust, superinduce on the ellipsoidal form undulations which we cannot express by any formula. Extensive geodetical operations enable us however to determine a spheroid to which the mathematical surface of the earth can be very conveniently referred, and from which its deviations are probably very small. Designate this spheroid of reference  $E$ , and the actual mathematical surface of the earth  $S$ . Let  $A, B, C, \dots$  be a series of points on  $S$ ,  $A_1, B_1, C_1, \dots$  their projections on  $E$ , then, as far as our present knowledge extends, the linear magnitudes  $AA_1, BB_1, CC_1, \dots$  are extremely small; that is to say, that representing the normal distance of  $S$  above  $E$  by  $\zeta$ , no observations yet made lead us to suppose that  $\zeta$  is anywhere anything but very minute compared with the difference of the semiaxes of the spheroid. In the early period of geodetic science the irregularity of the earth's figure made itself apparent principally by the very discordant values that were obtained by different combinations of short arcs for the ellipticity of the surface. The discordances resulted from the fact with which we are now familiar, that the observed latitude of any station,

although from its surroundings it may be apparently quite free from any suspicion of local attraction, is yet liable to an error of one or two seconds. This amount indeed is often exceeded, and it is not very uncommon to find, as in the vicinity of Edinburgh, a deflection of gravity to the extent of 5", while in the counties of Banff and Elgin there are cases of still larger deflections, the maximum of 10" being found at the village of Portsoy. At the base of the Himalayas, where we should naturally expect a large attraction, it amounts to about 30", diminishing somewhat rapidly as the distance from the mountains increases.

A very remarkable instance of such irregularities exists near Moscow<sup>1</sup>, brought to light through the large number of observed latitudes in that district. Drawing a line nearly east and west through the city, this line for a length of 50 or 60 miles, is the locus of the points at which the deflection of the direction of gravity northwards is a maximum, amounting nearly to 6" in the average, while along a parallel line eighteen miles to the south are found the points of maximum deflection southwards. Midway between these lines are found the points of no deflection. Thus there is plainly indicated the existence beneath the surface, if not of a cavity, yet of a vast extent of matter of very small density. Deflections much exceeding these in amount exist in the Caucasus and in the Crimea.

## 2.

If we conceive the small quantity  $\zeta$  to be expressed in terms of the latitude and longitude, then the surface  $S$  is strictly defined. If we put

$$\xi = \frac{d\zeta}{\rho d\phi}, \quad \eta = \frac{d\zeta}{\rho \cos \phi d\omega},$$

then  $\xi, \eta$  are the inclinations of the surface  $S$  at  $A$  to the surface  $E$  at  $A_1$ , thus the latitude of  $A_1$  is greater by  $\xi$  than

<sup>1</sup> *Untersuchungen ueber die in der Naehе von Moskau stattfindende Local-Attraction*, von G. Schweizer. Moskau, 1863.

the latitude of  $A$ , and the longitude of  $A_1$  is greater than that of  $A$  by  $\eta \sec \phi$ .

With respect to the observed direction of the meridian, in the adjoining figure, let  $Z, Z_1$  be the zeniths of  $A, A_1$ ;  $P$  the pole,  $Q$  the place of a terrestrial signal referred by its direction to the sphere of the heavens.  $Z_1PH$  and  $Z_1QK$  being each equal to  $90^\circ$ , as also  $ZPh$  and  $ZQk$ ; the azimuth of  $Q$  as measured with a theodolite is  $a = hk$ , whilst  $HK = a_1$  is the same azimuth as referred to the spheroid  $E$ . Produce  $HPZ_1$  to  $O$  and draw  $ZO$  perpendicular to  $Z_1O$ , then  $Z_1O = \xi$  and  $ZO = \eta$ . Then since  $PZ = 90^\circ - \phi$ ,  $HP h$  is  $\eta \sec \phi$ , and therefore the distance of  $h$  from  $PH$  is  $\eta \tan \phi$ . Again the angle

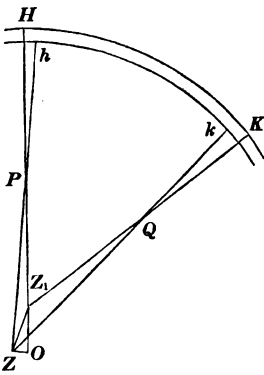

Fig. 57.

$$ZQZ_1 = \frac{\xi \sin a - \eta \cos a}{\cos e},$$

where  $e$  is the angle of elevation of the signal, and the distance of  $k$  from  $KQ$  is consequently  $(\xi \sin a - \eta \cos a) \tan e$ . Thus we have

$$a_1 = a + \eta \tan \phi + (\xi \sin a - \eta \cos a) \tan e. \quad (1)$$

Supposing then that, as is always the practice, the pole star is observed in connection with a mark which is at a zenith distance of very nearly  $90^\circ$ , the term in  $\tan e$  becomes insensible and may be omitted. Thus there exist the following relations between  $A$  and  $A_1$ . If  $\phi, \omega$  be the latitude and longitude of  $A$ ,  $\phi_1, \omega_1$  the latitude and longitude of  $A_1$ ,  $a$  the observed azimuth of a terrestrial signal,  $a_1$  the same azimuth as referred to  $A_1$ , then

$$\begin{aligned} \phi_1 &= \phi + \xi \\ \omega_1 &= \omega + \eta \sec \phi \\ a_1 &= a + \eta \tan \phi. \end{aligned} \quad (2)$$

Since measured base lines are reduced to the surface of the sea, and since the angles measured by theodolites are the same as if measured also on that surface, it follows that

trigonometrical operations may be considered as virtually conducted on the surface  $S$ . But the angles measured amongst the points  $A, B, C, \dots$  are not identical with the angles measured amongst their projections  $A_1, B_1, C_1, \dots$ . It appears in fact from (1) that the horizontal angle measured between two objects whose azimuths and elevations are  $a, a', e, e'$ , is affected to the extent

$$\xi (\sin a' \tan e' - \sin a \tan e) - \eta (\cos a' \tan e' - \cos a \tan e)$$

by the difference of the zeniths of  $A$  and  $A_1$ . Since therefore for the distant objects observed in a trigonometrical survey,  $e$  is generally very small, and since in ordinary cases  $\xi, \eta$  are but a very few seconds, we infer that the angles observed among the points  $A, B, C, \dots$  on  $S$  are not sensibly different from the corresponding angles between the points  $A_1, B_1, C_1, \dots$  on  $E$ . We are therefore justified in regarding the triangulation as projected on  $E$ , and calculating it as indicated in chapters ix and x.

### 3.

Suppose now that we have given the distance of two points,  $A, B$ , at each of which there are astronomical determinations of latitude, longitude, and azimuth: and let the following notation express the correspondence of the observed elements with the reduced quantities appertaining to  $A_1, B_1$

$A$	$A_1$	$B$	$B_1$
$\phi$	$\phi + \xi$	$\phi'$	$\phi' + \xi'$
$0$	$\eta \sec \phi$	$\omega$	$\omega + \eta' \sec \phi'$
$a$	$a + \eta \tan \phi$	$a'$	$a' + \eta' \tan \phi'$

If starting from  $A$  with the given distance, and  $a, \phi$  we calculate the elements at  $B$ , and get the numerical results  $(\phi') (\omega) (a')$ , then with the same distance, and  $a + \eta \tan \phi$  for  $a$ ,  $\phi + \xi$  for  $\phi$  and a longitude  $\eta \sec \phi$  for  $A_1$ , we should by equations (14) page 277, omitting  $d\theta$ , get for  $B_1$

$$\begin{aligned} \phi_1' &= (\phi') + \cos \omega \xi - n \sin \omega \sin \phi \eta, & (3) \\ \omega_1 &= (\omega) + \frac{\sin \phi' \sin \omega}{\cos \phi'} \xi - \left( \frac{\sin \theta \cos a'}{\cos \phi'} \tan \phi - \sec \phi \right) \eta, \\ a_1' &= (a') + \frac{\sin \omega}{\cos \phi'} \xi + \frac{\sin \phi \cos \omega}{\cos \phi'} \eta; \end{aligned}$$

these being equated to the elements at  $B_1$  as written above, we get

$$\xi' = (\phi') - \phi' + \cos \omega \xi - n \sin \omega \sin \phi \eta,$$

$$\sec \phi' \eta' = (\omega) - \omega + \frac{\sin \phi' \sin \omega}{\cos \phi'} \xi + \left( - \frac{\sin \theta \cos \alpha'}{\cos \phi'} \tan \phi + \sec \phi \right) \eta,$$

$$\tan \phi' \eta' = (\alpha') - \alpha' + \frac{\sin \omega}{\cos \phi'} \xi + \frac{\sin \phi \cos \omega}{\cos \phi'} \eta.$$

Hence it appears at once that the observation of the difference of longitude gives us no information that is not also given by the observation of azimuth; it affords however a check upon the work.

If instead of two points we have a network of triangles, then at every point where there are astronomical determinations we can express the  $\xi'$  and  $\eta'$  belonging to that point in terms of  $\xi$  and  $\eta$ . Now  $\xi$  and  $\eta$  are unknown, but we may suppose the spheroid  $E$  so placed with reference to  $S$ —its axis parallel to the earth's axis of rotation—or rather so placed with reference to the portion of  $S$  covered by the triangulation that the sum of the squares of all the  $\xi$ 's and  $\eta$ 's is a minimum. This condition determines  $\xi$  and  $\eta$ , and  $\xi'$ ,  $\eta'$  ... for all the other stations follow from the equations. It is further to be supposed with reference to the position of  $E$  that the mean value of  $\zeta$  over the surface considered is evanescent.

By the method just explained we see how in a network of triangulation a system of deflections may be assigned having reference to a definite ellipsoid  $E$  in a definite position: for any other ellipsoid differing slightly from  $E$  a somewhat different system would have resulted, and in fact if we leave the semi-axes indeterminate—that is to say—express them in a symbolical form, then we can from the equations of condition which arise determine that particular ellipsoid, call it  $\mathcal{E}$ , for which the sum of the squares of all the deflections is a minimum. Thus we obtain an ellipsoid which we may consider to represent better than any other that portion of  $S$  over which the triangulation extends.



Let the semiaxes of  $\mathcal{E}$  be  $(a) + da$  and  $(c) + dc$ , where  $(a)$ ,  $(c)$  are approximate numerical values,  $da$ ,  $dc$  small quantities to be determined. It is necessary to remark in the first place that the spherical excesses of the triangles having been calculated from the elements  $(a)$ ,  $(c)$ , there is an inconsistency in supposing these triangles to be laid on  $\mathcal{E}$ . But it may be shown that the error thus introduced is insignificant.

The spherical excess  $\epsilon$  of a triangle being proportional to

$$\frac{(a^2 \cos^2 \phi + c^2 \sin^2 \phi)^2}{a^4 c^2};$$

if we take the logarithmic differential and substitute for  $\phi$  in the result its equivalent in terms of  $u$  the reduced latitude, we get

$$-\frac{d\epsilon}{2\epsilon} = (1 - \cos 2u) \frac{da}{a} + \cos 2u \frac{dc}{c}.$$

To form some estimate of the effect of this alteration of  $\epsilon$  take the large polygon calculated at page 222. The spherical excess of the largest triangle here is  $49''\cdot 03$ . If, taking  $da$ ,  $dc$  of opposite signs so as to make the effect on  $\epsilon$  the greater, we put  $da = 1000$  ft.,  $dc = -1000$ , we get  $-d\epsilon = \frac{1}{8800} \epsilon$  approximately. Thus as in the largest triangle such an alteration would affect the spherical excess by less than one hundredth of a second, it is clear that the sides and angles of the whole figure are not appreciably affected by any such change in the elements of the spheroid.

Instead of using the polar semiaxis  $c$ , let  $\mathcal{E}$  be defined by  $(a) + da$  and  $(e) + de$ , and in equations (14), page 277, let  $d\theta$  be replaced by its equivalent in  $da$  and  $de$ . Then as in the case we have just considered, put  $d\phi = \xi$ ,  $da = \eta \tan \phi$ , and for brevity write those equations thus:

$$\phi_1' = (\phi') + A\xi + B\eta + C da + E de,$$

$$\omega_1' = (\omega) + A'\xi + B'\eta + C' da + E' de,$$

$$\alpha_1' = (\alpha') + A''\xi + B''\eta + C'' da + E'' de,$$

where  $B'$  includes a term  $\sec \phi$  as in (3). Here  $(\phi')$ ,  $(\omega)$ ,  $(\alpha')$  are the astronomical elements at  $B_1$  as calculated with the observed latitude and azimuth at  $A_1$  and with the  $(a)$ ,  $(e)$  of

the approximate spheroid. Then if  $\xi' \eta'$  belong to  $B$ ,

$$\begin{aligned}\xi' &= (\phi') - \phi' + A \xi + B \eta + C da + E de, \\ \sec \phi' \eta' &= (\omega) - \omega + A' \xi + B' \eta + C' da + E' de, \\ \tan \phi' \eta' &= (\alpha') - \alpha' + A'' \xi + B'' \eta + C'' da + E'' de.\end{aligned}$$

#### 4.

In the *Account of the Principal Triangulation of Great Britain and Ireland* will be found at pages 693 and 694 seventy-six equations of the kind just written down; of these, thirty-five arise from observed latitudes and forty-one from observed azimuths and longitudes. The solution of these equations by the method of least squares determines the axes of that particular spheroid  $\mathcal{E}$  which most nearly represents the surface of this country, and also, by  $\xi \eta$ , the inclination of the surface of  $\mathcal{E}$  at Greenwich Observatory—to which  $\xi \eta$  belong—to the surface  $S$  there. From these follow the  $\xi' \eta'$  of every other point. The semi-axes of  $\mathcal{E}$  are

$$a = 20927005, \quad e = 20852372.$$

The azimuth and longitude equations are, from the nature of those observations, entitled to much less weight than the latitude equations: the azimuth equations in particular are directly affected by accumulation of errors of the observed angles of the triangulation. Hence the explanation of the fact that the average values of the resulting quantities  $\eta$  is somewhat larger than that of the  $\xi$ 's. It is interesting to compare the values of the quantities  $\xi$ , which we may take to be local deflections of gravity in the direction of the meridian, obtained as above, with the deflections calculated from the form of the ground around the stations—for those stations at least where the means of making such calculation exist.

In estimating from the form of the ground the deflection of gravity, an element of uncertainty exists in our not knowing exactly to what distance from the station the calculation should be extended; for according to the views explained at page 97 it is very doubtful whether the influence of distant masses should be taken into account. Accordingly in the fourth column of the following table the influence of masses

at distances exceeding nine or ten miles is excluded—in the fifth column the calculation is extended to these more distant masses :—

NAME OF STATION.	SITUATION.	DEFLECTIONS.		
		ξ	FROM THE GROUND.	
Dunnose ... ..	} Near Ve'nor } Isle of Wight	- 1.62	- 1.02	- 0.54
Boniface ... ..		+ 0.80	+ 1.94	+ 2.42
Week Down ... ..		+ 0.58	+ 1.50	+ 1.9
Port Valley ... ..		+ 1.61	+ 2.81	+ 3.29
Clifton ... ..	Yorkshire ...	- 2.56	- 0.90	
Burleigh Moor ...	"	- 3.54	- 3.03	- 4.55
Hungry Hill ... ..	Cork ... ..	+ 2.92	+ 3.85	+ 5.40
Feaghmain ... ..	Kerry ... ..	- 0.88	- 1.95	
Forth ... ..	Wexford ... ..	+ 0.26	- 0.17	+ 1.13
Tawnaghmore ...	Mayo ... ..	- 0.95	- 1.43	- 2.30
Lough Foyle ... ..	Londonderry ...	- 4.48	- 2.15	- 4.02
Kellie Law ... ..	Fifeshire ... ..	+ 1.82	+ 2.08	
Monach ... ..	Hebrides ... ..	+ 1.36	+ 0.47	
Ben Hutig ... ..	Sutherland ...	- 2.86	- 1.63	- 2.01
Calton Hill ... ..	Edinburgh ...	- 5.30	- 2.43	- 3.57
Cowhythe ... ..	Banffshire ...	- 9.55	(- 2)	(- 5)

The quantities in the last two columns for Cowhythe are only roughly calculated.

The triangulation being considered as projected on the ellipsoid  $\mathcal{E}$  as finally determined, we can at each point where azimuth observations have been made obtain an apparent error of observed azimuth at that point. On forming these errors for sixty-one stations in this country it is found that twenty-three errors are under 3", ten between 3" and 4", and there is one error of 11". The probable error of azimuth of the triangulation of Great Britain as a whole is  $\pm 0''.69$ .

## 5.

The calculation of the disturbance of the direction of gravity at any station  $J$  due to the irregular distribution of masses of ground in the surrounding country presents no difficulty

if we possess a map of the district, showing by contours or otherwise the heights of the ground. Let there be drawn on this map a number of circles having  $J$  for a common centre, and also a series of radial lines through  $J$ : thus dividing the country into a series of four-sided compartments. Let  $a, a'$  be the azimuths of two consecutive lines,  $r, r'$  the radii of two consecutive circles, and let it be required to find the attraction at  $J$ —or rather the component of the attraction acting in the direction north—of the mass  $M$  of the compartment contained between those limits of azimuth and distance: the upper surface of  $M$  being supposed a plane. Put  $a, r$  for the azimuth and horizontal distance of any particle of this mass,  $\rho$  its density,  $z$  its height above  $J$ , then its mass is  $\rho r da dr dz$ , and the component of attraction required is— $\rho$  being supposed constant

$$A = \rho \int_{a_1}^{a'} \int_{r_1}^{r'} \int_0^h \frac{r^2 \cos a da dr dz}{(r^2 + z^2)^{\frac{3}{2}}},$$

where  $h$  is the height of the upper surface of  $M$  above  $J$ . Hence

$$\begin{aligned} A &= \rho (\sin a' - \sin a_1) \int_{r_1}^{r'} \int_0^h \frac{r^2 dr dz}{(r^2 + z^2)^{\frac{3}{2}}}, \\ &= \rho h (\sin a' - \sin a_1) \int_{r_1}^{r'} \frac{dr}{(r^2 + h^2)^{\frac{1}{2}}}, \\ &= \rho h (\sin a' - \sin a_1) \log_e \frac{r' + \sqrt{r'^2 + h^2}}{r_1 + \sqrt{r_1^2 + h^2}}. \end{aligned}$$

In exceptional cases only is it necessary to take into account  $h^2$ , namely when the station is in the immediate vicinity of very steep ground, generally it may be neglected. In ordinary cases then the attraction due to  $M$  is

$$\rho h (\sin a' - \sin a_1) \log_e \frac{r'}{r_1},$$

or if the straight lines be so drawn that the sines of their azimuths are in arithmetic progression, having a common difference  $k$ , and the radii of the circles in geometric progression, the logarithm (Napierian) of the common ratio being  $l$ , then the whole attraction to the north is

$$A = \rho k l \{ \Sigma(h) - \Sigma(h') \},$$

where  $\Sigma(h)$  is the sum of the heights of compartments north of the station,  $\Sigma(h')$  the sum of the heights of those south.

Now if we regard the earth as a sphere of radius  $r$  and mass  $M$  then the angular deflection of the direction of gravity  $D$  resulting from an attraction  $A$  is

$$D = \frac{c^2}{M} A.$$

Taking  $r$  as 3960 miles, and putting  $\rho_0$  for the mean density of the earth,  $D$  expressed in seconds is

$$D = 12''.44 \frac{A}{\rho_0},$$

where it is supposed that the unit of length in the calculation of  $A$  is the mile.

In the case we have just been considering

$$D = 12''.44 \frac{g}{\rho_0} k l \{ \Sigma(h) - \Sigma(h') \}. \quad (4)$$

This method was first adopted for the calculation of the attraction of Shiehallion in the celebrated experiment of Dr. Maskelyne for the determination of  $\rho_0$ .

Here we have supposed that the calculation is not extended so far as to require any notice of the curvature of the earth's surface. If it is necessary to take this into consideration then it is easy to see that  $r$  being now angular distance, the component, in the direction of north, of the attraction of the mass standing in a compartment limited by azimuths  $a, a'$  and distances  $r, r'$  is

$$\begin{aligned} A &= \frac{1}{2} g h (\sin a' - \sin a) \int_r^{r'} \frac{\cos^2 \frac{1}{2} r}{\sin \frac{1}{2} r} dr, \\ &= g h (\sin a' - \sin a) \left( \log_e \frac{\tan \frac{1}{4} r'}{\tan \frac{1}{4} r} + \cos \frac{1}{2} r' - \cos \frac{1}{2} r \right). \end{aligned}$$

The attraction of an elevated table land whose upper surface is nearly a plane and its outline rectangular may be obtained thus. Taking the attracted point as origin of rectangular co-ordinates  $xy$  in the horizontal plane and  $z$  vertical, let the solid be bounded by the planes

$$\begin{array}{lll} x = a, & y = 0 & z = 0 \\ x = a', & y = b & z = h, \end{array}$$

$h$  being very small in comparison with the other dimensions  $a' - a$ , and  $b$ . The  $x$ -component of the attraction is

$$\begin{aligned} A &= \epsilon \int_a^{a'} \int_0^h \int_0^h \frac{x \, dx \, dy \, dz}{(x^2 + y^2 + z^2)^{\frac{3}{2}}}, \\ &= \epsilon \int_a^{a'} \int_0^h \frac{bx \, dx \, dz}{(x^2 + z^2)(x^2 + b^2 + z^2)^{\frac{1}{2}}}, \\ &= \epsilon \int_0^h dz \log_e \left\{ \frac{(a'^2 + z^2)^{\frac{1}{2}} b + \sqrt{b^2 + a'^2 + z^2}}{a^2 + z^2} \right\}. \end{aligned}$$

Now if we neglect the higher powers of  $z^2$  and put

$$b = a \cot \phi, = a' \cot \phi'$$

this becomes

$$\begin{aligned} \epsilon \int_0^h \log_e \left\{ \frac{\tan \frac{1}{2} \phi'}{\tan \frac{1}{2} \phi} \left( 1 + \frac{1}{2} \frac{z^2}{a'^2} \cos \phi' - \frac{1}{2} \frac{z^2}{a^2} \cos \phi \right) \right\} dz, \\ = \epsilon h \log_e \frac{\tan \frac{1}{2} \phi'}{\tan \frac{1}{2} \phi} + \frac{1}{8} \epsilon h^3 \left( \frac{\cos \phi'}{a'^2} - \frac{\cos \phi}{a^2} \right). \end{aligned} \quad (5)$$

The corresponding deflection is obtained by replacing  $\epsilon$  by  $6'' \cdot 22$ , if the attracting mass be of a density equal to half the mean density of the earth.

If for example we suppose a table land extending twelve miles in length by eight miles in breadth, and having a height of 500 feet, then at an external point two miles perpendicularly distant from the middle point of the longer side the deflection would be  $1'' \cdot 47$ . In this case the term in  $h^3$  is not perceptible.

The attraction of a prism of indefinite length whose section is a trapezoid  $HSS'H'$ , at a point  $O$  in the plane of one of the faces  $SS'$ , admits of a tolerably simple expression from which we may obtain an approximation to the deflection that would be caused by a rectilinear range of mountains of somewhat regular section. Let

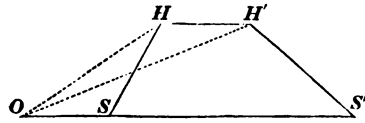

Fig. 58.

$$\begin{aligned} HOS &= \phi, & H'OS &= \phi', \\ HSS' &= \sigma, & H'S'S &= \sigma', \\ OS &= c, & OS' &= c', \\ OH &= b, & OH' &= b'; \end{aligned}$$

put further

$$z^2 + (c + z \cot \sigma)^2 = u^2, \quad z^2 + (c' - z \cot \sigma')^2 = u'^2.$$

Then the limits being for  $y$ , 0 and  $\infty$ ; for  $x$ ,  $c' - z \cot \sigma'$  and  $c + z \cot \sigma$ ; for  $z$ , 0 and  $h$ , we have

$$\begin{aligned} A &= 2 \xi \iiint \frac{x dx dy dz}{(x^2 + y^2 + z^2)^{\frac{3}{2}}}, \\ &= \xi \iint \frac{x dx dz}{x^2 + z^2} = \xi \int \log \left( \frac{u'}{u} \right)^2 dz, \\ &= \xi z \log \left( \frac{u'}{u} \right)^2 - \xi \int z \frac{d}{dz} \log \left( \frac{u'}{u} \right)^2 dz. \end{aligned}$$

The integration presents no difficulty: the result is

$$A = \xi \log_e \left\{ \left( \frac{c'}{b'} \right)^{c' \sin 2\sigma'} \cdot \left( \frac{c}{b} \right)^{c \sin 2\sigma} \cdot \left( \frac{b'}{b} \right)^{2h} \right\} + 2 \xi \{ c' \phi' \sin^2 \sigma' - c \phi \sin^2 \sigma \};$$

and if we replace  $\xi$  by  $6'' \cdot 22$ , we get the deflection on the supposition that the mountains are of half the mean density of the earth.

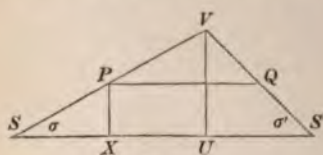

Fig. 59.

Suppose the section to be triangular as  $SVS'$ . From the formula last written down we can obtain the

following expression for the deflection at any point as  $P$  on the slope  $SV$ ; drawing  $PQ$ ,  $PX$  parallel and perpendicular to the base, the deflection, call it  $v$ , is

$$6'' \cdot 22 \left\{ PX \log \left( \frac{PS'}{PS} \right)^2 + \frac{1}{2} PQ \sin 2\sigma' \log \left( \frac{PS'}{PV} \right)^2 + 2 PQ \sin^2 \sigma' (\sigma + QPS') \right\}.$$

Suppose for instance the height  $VU =$  half a mile,  $SU =$  one mile,  $US' =$  two miles, then the deflections in seconds at various points will be as shown in the following figure:

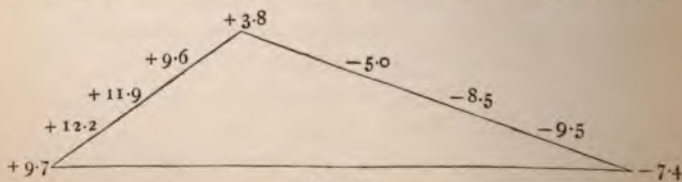

Fig. 60.

The maximum attraction finds place here at about one-fourth of the height from the base.

## 6.

It is interesting to enquire into the amount of error that would be introduced by such attractions into the process of levelling over a chain of mountains. For instance, if spirit levelling is carried from  $S$  over  $V$  to  $S'$  and again from  $S$  through an imaginary tunnel in a straight line from  $S$  to  $S'$ , what is the discrepancy produced by the attraction of the hill between the two results obtained for the height of  $S'$ ? In the operation of levelling, the observer has his instrument midway between two levelling staves, one in advance, the other behind. The difference of level is always given by  $R, -R'$ , where  $R$ , is the reading of the back staff,  $R'$  that of the front. But if there be a deflection of the amount  $v$ —the attraction being counted positive in the direction in which the leveller is moving—and if  $dx$  be the small horizontal distance between the staves in any one position of the instrument, then the measured difference of height  $R, -R'$  requires the correction  $v dx$ . Let  $v'$  be the deflection at any point of  $SS'$ , then if  $H$  be the height obtained at  $S'$  by the route  $SVS'$  and  $H'$  the height obtained by the direct route  $SS'$

$$H + \int v dx = H' + \int v' dx,$$

so that the difference between the heights obtained is

$$\int v dx - \int v' dx.$$

In the *Astronomische Nachrichten*, No. 1916, pp. 314–318, is an investigation of the integral  $\int v dx$ : we may express the result thus, putting  $SV = s$ ,  $VS' = s'$ ,  $SS' = a$ , the area of  $SVS' = \Delta$ , and omitting for a moment the coefficient  $6'' \cdot 22$

$$\frac{1}{2\Delta} \int v dx = \cos(\sigma' - \sigma) \left\{ \frac{s}{s'} \log \frac{a}{s} - \frac{s'}{s} \log \frac{a}{s'} \right\} + \sin(\sigma' - \sigma) \left\{ \frac{s'\sigma'}{s} + \frac{s\sigma}{s'} \right\}$$



Again  $-\int v' dx$  is the excess of the potential of the mass at  $S$  above its potential at  $S'$ : this, see p. 94, is

$$-\frac{1}{2\Delta} \int v' dx = \\ -\cos(\sigma' + \sigma) \left\{ \frac{s}{s'} \log \frac{a}{s} - \frac{s'}{s} \log \frac{a}{s'} \right\} + \sin(\sigma' + \sigma) \left\{ \frac{s'\sigma'}{s} - \frac{s\sigma}{s'} \right\}$$

adding these together we have for the discrepancy  $H-H'$  of the levelling, this expression

$$2\Delta \left\{ \left( \frac{h}{s} \right)^2 \log \left( \frac{a}{s} \right)^2 - \left( \frac{h}{s'} \right)^2 \log \left( \frac{a}{s'} \right)^2 + \sigma' \sin 2\sigma - \sigma \sin 2\sigma' \right\},$$

to which we have to restore the coefficient  $6''.22$ . If we wish this small quantity expressed in feet, it must be still multiplied by  $5280 \times \sin 1''$ , or in other words, for  $2\Delta$  we must write  $0.318\Delta$ .

Suppose for example that the height be one mile, the base of the slope  $s$  one mile, that of the slope  $s'$  three miles, then the error in the close of the levelling is 0.11 foot.

## 7.

Before concluding this subject, we may briefly notice the determination of the mean density of the earth from observations of latitude made (in connection with the Ordnance Survey), at three stations on Arthur's Seat, Edinburgh, in 1855. One of the stations was on the northern slope of the hill, at about one-third of the altitude from the base; the second station was on the summit; the third on the southern face of the hill, and at about the same height as the first. From a total of 1260 observations of stars it was found that the difference of latitude ( $\delta_1$ ) of the north station and the summit, and ( $\delta_2$ ) of the summit and south station, were respectively

$$\delta_1 = 25''.53 \pm 0''.04, \quad \delta_2 = 17''.00 \pm 0''.04,$$

while according to the trigonometrical distances of the stations the differences should be

$$\delta_1' = 24''.27, \quad \delta_2' = 14''.19.$$

By the use of the formula (4) the following values were obtained for the deflections (northwards) at the north station, the summit, and south station respectively

$$-5''.237z, \quad -2''.399z, \quad +2''.700z,$$

where  $z$  is the ratio of the mean density of the hill to that of the earth. Now there is reason to believe that there exists a general deflection to the south common to all these stations, let this be  $-\psi$ ; then on equating the astronomical latitudes corrected for attraction with the latitudes derived from the triangulation we have

$$\phi + \delta_1 - 5.237z + \psi = \phi_1 + \delta_1'$$

$$\phi - 2.399z + \psi = \phi_1$$

$$\phi - \delta_2 + 2.700z + \psi = \phi_1 - \delta_2',$$

or putting  $\phi + \psi - \phi_1 = x$

$$x - 5.237z + \delta_1 - \delta_1' = 0$$

$$x - 2.399z = 0$$

$$x + 2.700z + \delta_2' - \delta_2 = 0,$$

from which, on supplying the values of  $\delta_1, \delta_1', \delta_2, \delta_2'$ , we have at once  $z$ . Finally the mean density of the hill having been found to be 2.75, that of the earth is consequently 5.316.

An admirable essay by Bessel on the subject of this chapter will be found in the *Astronomische Nachrichten*, No's. 329, 330, 331, entitled *Ueber den Einfluss der Unregelmässigkeiten der Figur der Erde, auf geodätische Arbeiten und ihre Vergleichung mit den astronomischen Bestimmungen.*

## CHAPTER XIII.

### FIGURE OF THE EARTH.

WE have seen how in comparing the surface of Great Britain with an ellipsoid of revolution there appear irregularities in that surface such as to produce apparent errors of several seconds in each and all of the observed latitudes; moreover we saw that the irregularities of the distribution of masses of ground round the astronomical stations—though not in every case explaining the exact amount of error—is yet sufficient to account for errors of the magnitude of those brought to light in the comparisons of the mathematical surface with the most nearly agreeing ellipsoid of revolution. The probable error then of an observed latitude, as due to local disturbance of gravity is certainly not less than  $\pm 1''\cdot 5$ , a quantity greatly exceeding the error that in any geodetic operations follows from errors of observation or measurement. We may then, dealing with these inevitable errors of latitude as purely accidental, treat them according to the method of least squares, and determine for the figure of the earth that ellipsoid or ellipsoid of revolution for which the sum of the squares of all the necessary corrections to the observed latitudes shall be a minimum. This method of regarding the problem seems first to have been, though only in a partial manner, carried out by Walbeck, afterwards more perfectly by Schmidt, and its full development is due to Bessel.

#### 1.

We may here glance at some of the earlier results obtained

for the figure of the earth. Those of Laplace in the *Mécanique Céleste* were very unsatisfactory owing to the very imperfect state of geodetic measures at that time. In Bowditch's notes to his translation of that work, vol. ii, page 453, we find the following expression for the length in feet of a meridian arc from the equator to latitude  $\phi$ ,

$$S = 101.259564 \phi'' - 50209.2 \sin 2\phi - 60.0 \sin 4\phi,$$

where  $\phi''$  is the latitude expressed in seconds. This curve is not restricted to the elliptic form: it is depressed below an ellipse described on the same axes, but the maximum depression is only 59 feet, in the latitude of  $45^\circ$ .

In the *Encyclopedia Metropolitana*, under the heading 'Figure of the Earth,' is the elaborate investigation of the Astronomer Royal. It is based on the discussion of fourteen meridian arcs and four arcs of parallel. The resulting semi-axes are

$$a = 20923713, \quad c = 20853810,$$

with,

$$a : c = 299.33 : 298.33.$$

Bessel's investigation made a few years after, viz. in 1841, is to be found in the *Astronomische Nachrichten*, Nos. 333, 438. He obtained

$$a = 20923600, \quad c = 20853656,$$

with,

$$a : c = 299.15 : 298.15.$$

The agreement of these results of Airy and Bessel, obtained by very different methods of calculation, is very striking; but we now know that, owing to the defectiveness of the then existing data, both are considerably in error.

During the sixteen years following, great additions were made to the data; the Russian arc was extended from  $8^\circ$  to  $25^\circ$ , the English from  $3^\circ$  to  $11^\circ$ , and the Indian arc extended  $5\frac{1}{2}^\circ$ . An investigation, by Captain Clarke, R.E., based on these new arcs is to be found in the *Account of the Principal Triangulation of Great Britain and Ireland*. The data used in this investigation are: 1st, the combined French and English arcs,  $22^\circ 9'$ ; 2nd, the Russian arc  $25^\circ 20'$ ; 3rd, the Indian arc  $21^\circ 21'$ ; 4th, an earlier Indian arc of  $1^\circ 35'$ ; 5th, Bessel's Prussian arc of  $1^\circ 30'$ ; 6th, the Peruvian arc  $3^\circ 7'$ ; 7th, the

Hanoverian arc  $2^{\circ} 1'$ ; and 8th, the Danish arc  $1^{\circ} 32'$ . The small arcs however have very little influence in the result.

In this investigation the figure of the meridian is not restricted to the elliptic form. The radius of curvature is supposed to be expressed by the formula

$$\xi = A + 2B \cos 2\phi + 2C \cos 4\phi. \quad (1)$$

This represents an ellipse if  $5B^2 - 6AC = 0$ . The coordinates  $x, y$ , of the point  $Q$ , whose latitude is  $\phi$ , are

$$\begin{aligned} x &= -\int \xi \sin \phi \, d\phi = (A-B) \cos \phi + \frac{1}{3} (B-C) \cos 3\phi \\ &\quad + \frac{1}{5} C \cos 5\phi, \\ y &= \int \xi \cos \phi \, d\phi = (A+B) \sin \phi + \frac{1}{3} (B+C) \sin 3\phi \\ &\quad + \frac{1}{5} C \sin 5\phi; \end{aligned}$$

whence follow at once the semiaxes,

$$a = A - \frac{2}{3}B - \frac{2}{15}C, \quad c = A + \frac{2}{3}B - \frac{2}{15}C.$$

Let  $x', y'$  be the coordinates of a point  $P$  in latitude  $\phi$  in an ellipse described on these same semiaxes: measure  $PS$  along the ellipse and  $SQ$  perpendicular to it, then

$$\begin{aligned} PS &= -(x-x') \sin \phi + (y-y') \cos \phi, \\ SQ &= (x-x') \cos \phi + (y-y') \sin \phi; \end{aligned}$$

expressing these by  $\delta s$  and  $\delta r$ , it may be shown that

$$\begin{aligned} \delta s &= \frac{4A}{45} \left\{ 6 \frac{C}{A} - 5 \frac{B^2}{A^2} \right\} \sin 4\phi, \\ \delta r &= \frac{2A}{45} \left\{ 6 \frac{C}{A} - 5 \frac{B^2}{A^2} \right\} \sin^2 2\phi; \end{aligned}$$

this last expressing the protuberance of the curve (1) above an ellipse described on the same axes.

The distance of two points on the curve (1) whose latitudes are  $\phi - \frac{1}{2}a$  and  $\phi + \frac{1}{2}a$  is

$$s = Aa + 2B \sin a \cos 2\phi + C \sin 2a \cos 4\phi.$$

Suppose now that each of the observed latitudes in the different arcs has a symbolical correction  $x$  attached, such as to bring them into harmony with the curve (1). Then  $A, B, C$  are determined so that  $\Sigma(x^2)$  is an absolute minimum. The resulting semiaxes are

$$a = 20927197, \quad c = 20855493,$$

and

$$a : c = 291.86 : 290.86.$$

The quantity  $\delta r$  by which the curve is more protuberant than an ellipse on the same axes is  $(177 \pm 70) \sin^2 2\phi$ . This is a satisfactory indication that the actual curve differs but very slightly from the ellipse. But on restricting the curve to an ellipse, the same data give

$$a = 20926348, \quad c = 20855233,$$

and  $a : c = 294.26 : 293.26$ .

But these conclusions were vitiated by the then existing uncertainty as to the unit of length on which the southern half of the Indian arc depended—an uncertainty which is now removed by the recent remeasurement of the arc from Damargida to Punnaë.

2.

In the *Memoirs of the R. A. Society*, vol. xxix, is an investigation of the figure of the earth regarded as a possible ellipsoid, suggested by General T. F. de Schubert's '*Essai d'une détermination de la véritable Figure de la Terre.*' In this enquiry one has first of all to define parallels and meridians; the colatitude of a point, being still the angle made by the normal to the surface there with the axis of rotation. A meridian may be defined either as the locus of points, whose zeniths lie in a great circle of the heavens, whose poles are in the equator or at which the normals are perpendicular to a fixed line in the plane of the equator—or we may define the meridian as a line whose direction is north and south. But these lines as we shall see are of different characters, and we shall call this last a north line.

If  $a, b$  be the semiaxes of the equator of which we shall suppose  $a$  to be the greater,  $c$  the polar semiaxis, the equation of the surface is

$$\frac{x^2}{a^2} + \frac{y^2}{b^2} + \frac{z^2}{c^2} = 1. \tag{2}$$

The direction cosines of the normal at  $x, y, z$  being proportional to

$$\frac{x}{a^2}, \quad \frac{y}{b^2}, \quad \frac{z}{c^2};$$

if  $\phi$  be the latitude of points on a parallel it is easy to see that

$$\frac{x^2}{a^4} + \frac{y^2}{b^4} - \frac{z^2}{c^2} \cot^2 \phi = 0. \quad (3)$$

Again, for a meridian, if the normals are to be perpendicular to the line whose direction cosines are proportional to

$$-\sin \omega : \cos \omega : 0,$$

we must have for the equation of a meridian

$$-\frac{x}{a^2} \sin \omega + \frac{y}{b^2} \cos \omega = 0; \quad (4)$$

the positive extremity of the semiaxis  $a$  being in longitude 0.

From the three equations (2), (3), (4), if we put

$$a^2(1-i) = k^2 = b^2(1+i),$$

we get

$$x = \frac{k}{N^{\frac{1}{2}}} \cdot \frac{\cos \omega}{1-i}, \quad (5)$$

$$y = \frac{k}{N^{\frac{1}{2}}} \cdot \frac{\sin \omega}{1+i},$$

$$z = \frac{k}{N^{\frac{1}{2}}} \cdot \frac{c^2 \tan \phi}{k^2},$$

$$N = 1 + \frac{c^2}{k^2} \tan^2 \phi + \frac{i \cos 2\omega + i^2}{1-i^2}.$$

Let us now consider the north line. Suppose that a point on the surface of the ellipsoid moves always towards a given fixed point  $x' y' z'$ , and let it be required to determine the nature of the curve traced by this moving point. Two consecutive points on the curve having coordinates  $xyz$ ,  $x+dx$ ,  $y+dy$ ,  $z+dz$  give the condition

$$\frac{x}{a^2} dx + \frac{y}{b^2} dy + \frac{z}{c^2} dz = 0. \quad (6)$$

The equation of a plane passing through  $xyz$  and  $x' y' z'$  is

$$A(x'-x) + B(y'-y) + C(z'-z) = 0.$$

This plane is to contain the normal at  $xyz$  and the point  $x+dx$ ,  $y+dy$ ,  $z+dz$ , which conditions give two other equations in  $ABC$ : and eliminating these symbols we have the

differential equation of the required curve expressed by the determinant

$$\begin{vmatrix} x'-x, & y'-y, & z'-z, \\ dx, & dy, & dz, \\ \frac{x}{a^2}, & \frac{y}{b^2}, & \frac{z}{c^2}, \end{vmatrix} = 0;$$

the north line is a particular case of this general curve, viz. when  $x' = 0, y' = 0, z' = \infty$ : its equation is

$$a^2 y dx - b^2 x dy = 0, \tag{7}$$

of which the integral is  $x^{a^2} = Cy^{b^2}$ . It is therefore a line of 'greatest slope' with respect to the equator.

Let  $S$  be any point on the surface of the ellipsoid, say in that octant where  $xyz$  are all positive. Let  $SN, SM, SP$  be indefinitely small portions of the north line, meridian line, and parallel passing through  $S$ : and let it be required to find the angles these lines make with one another. If from (6) and (7) we determine the ratios

$$dx : dy : dz,$$

we find them to be as

$$-b^2 xz : -a^2 yz : c^2 \left( \frac{a^2 y^2}{b^2} + \frac{b^2 x^2}{a^2} \right),$$

and these are proportional to the direction cosines of  $SN$ . So also on differentiating the equation (4) of the meridian we find the ratios  $dx : dy : dz$  to be expressed by

$$-a^2 z \cos \omega : -b^2 z \sin \omega : c^2 (x \cos \omega + y \sin \omega),$$

and these are proportional to the direction cosines of  $SM$ .

Again, differentiating the equation (3) of the parallel we find for the ratios  $dx : dy : dz$

$$-a^2 yz \left( \frac{1}{b^2} + \frac{\cot^2 \phi}{c^2} \right) : b^2 xz \left( \frac{1}{a^2} + \frac{\cot^2 \phi}{c^2} \right) : c^2 xy \left( \frac{1}{b^2} - \frac{1}{a^2} \right),$$

which are proportional to the direction cosines of  $SP$ .

From these ratios we have no difficulty in finding the required angles. Supposing  $i$  to be a very small quantity, whose square is to be neglected, the coordinates  $x, y, z$  are proportional to

$$(1 + i) \cos \omega : (1 - i) \sin \omega : \frac{c^2}{k^2} \tan \phi,$$



by the substitution of these in the foregoing ratios we obtain finally

$$MSP = \frac{\pi}{2} - i \sin \phi \sin 2\omega - \frac{ic^2 \sin \phi \sin 2\omega}{c^2 \sin^2 \phi + k^2 \cos^2 \phi}, \quad (8)$$

$$NSP = \frac{\pi}{2} - \frac{ic^2 \sin \phi \sin 2\omega}{c^2 \sin^2 \phi + k^2 \cos^2 \phi}.$$

Thus for instance, if there be a difference of a mile between  $a$  and  $b$ , the angle between a meridian and parallel at a point in longitude  $45^\circ$ , and latitude  $\phi$  will be less than a right angle by about  $105'' \sin \phi$ . So large an angle as this should be detected by first rate geodetic operations though it would require a somewhat long measurement of meridian and parallel.

In an ellipsoidal earth the directions of the principal curvatures of the surface no longer coincide with meridians, parallels, or north lines. Supposing  $S$  is not in a very high latitude, one of the lines of curvature as  $SR$  through  $S$  will be somewhere in the direction of  $SP$ , and it may be shown that the angle

$$RSN = \frac{\pi}{2} - i \sin 2\omega \sin \phi \frac{c^2 \sec^2 \phi}{k^2 - c^2},$$

which however does not hold good in high latitudes: for in the vicinity of the umbilics the lines of curvature are approximately confocal conics having the umbilics as foci.

The results of the calculation referred to in vol. xxix. of the *M. R. A. S.* as subsequently corrected for errors in comparisons of standards stand thus:

Major semiaxis of Equator (long. $15^\circ 34'$ E.)	$a = 20926350$ ;
Minor semiaxis           ,,           (long. $74^\circ 26'$ W.)	$b = 20919972$ ;
Polar semiaxis           ,,	$c = 20853429$ .

But these are affected by the error in the southern half of the old Indian arc. A revision of this calculation based on the revision and extension of the Indian geodetic operations is to be found in the *Philosophical Magazine* for August 1878, resulting in the following numbers:

Major semiaxis of Equator (long. $8^\circ 15'$ W.)	$a = 20926629$ ;
Minor semiaxis           ,,           (long. $81^\circ 45'$ E.)	$b = 20925105$ ;
Polar semiaxis           ,,	$c = 20854477$ .

The meridian of the greater equatorial diameter thus passes through Ireland and Portugal, cutting off a small bit of the north-west corner of Africa: in the opposite hemisphere this meridian cuts off the north-east corner of Asia and passes through the southern island of New Zealand. The meridian containing the smaller diameter of the equator passes through Ceylon on the one side of the earth and bisects North America on the other. This position of the axes, brought out by a very lengthened calculation, certainly corresponds very remarkably with the physical features of the globe—the distribution of land and water on its surface. On the ellipsoidal theory of the earth's figure, small as is the difference between the two diameters of the equator, the Indian longitudes are much better represented than by a surface of revolution. But it is nevertheless necessary to guard against an impression that the figure of the equator is thus definitely fixed, for the available data are far too slender to warrant such a conclusion.

For the reduction of arcs of longitude in this enquiry we must form the expression for the length of an arc of parallel between given longitudes. By differentiating (5) we get

$$\begin{aligned} dx &= -\frac{k}{N^{\frac{3}{2}}} \cdot \frac{\sin \omega}{1-i} \left( \frac{1}{1+i} + \frac{c^2}{k^2} \tan^2 \phi \right) d\omega, \\ dy &= \frac{k}{N^{\frac{3}{2}}} \cdot \frac{\cos \omega}{1+i} \left( \frac{1}{1-i} + \frac{c^2}{k^2} \tan^2 \phi \right) d\omega, \\ dz &= \frac{k}{N^{\frac{3}{2}}} \cdot \frac{i \sin 2\omega}{1-i^2} \cdot \frac{c^2}{k^2} \tan \phi d\omega; \end{aligned}$$

the square root of the sum of the squares of these is, neglecting  $i^2$ ,

$$ds = k \left( 1 + \frac{c^2}{k^2} \tan^2 \phi \right)^{-\frac{1}{2}} \{ 1 - i (1 + \frac{1}{2} \cos^2 \phi) \cos 2\omega \} d\omega,$$

which integrated between the limits  $\omega$ , and  $\omega'$  gives

$$\frac{s}{k} = \frac{\omega' - \omega - \frac{1}{2} i (1 + \frac{1}{2} \cos^2 \phi) (\sin 2\omega' - \sin 2\omega)}{\left( 1 + \frac{c^2}{k^2} \tan^2 \phi \right)^{\frac{1}{2}}}.$$

But we return now to the ellipsoid of revolution.

## 3.

What we obtain by the linear measure of a few degrees of the meridian and the observation of the latitudes at the terminal points of the measure, is in reality nothing more than a value of the radius of curvature of the meridian at the middle point of the arc. If  $s$  be the length,  $\phi$  the middle latitude, and  $a$  the difference of the extreme latitudes, then excluding quantities of the order  $n^2$  in (17), page 111

$$\frac{1}{2}(a+c) - \frac{3}{2}(a-c) \cos 2\phi = \frac{s}{a}.$$

Or putting  $r$  for  $s : a$ , which is the radius of curvature,

$$a \frac{1-3 \cos 2\phi}{2} + c \frac{1+3 \cos 2\phi}{2} = r.$$

If we have another arc, giving in latitude  $\phi'$  the radius of curvature  $r'$ ,

$$a \frac{1-3 \cos 2\phi'}{2} + c \frac{1+3 \cos 2\phi'}{2} = r',$$

and from these two  $a$  and  $c$  can be determined. But to do so effectually, the coefficients of  $a$  and  $c$  in the two equations must not be nearly the same, that is the arcs must be situated in quite different latitudes. There are in particular two points in the meridian giving special results: at one of these the radius of curvature is  $a$ , viz. when

$$\cos 2\phi = -\frac{1}{3} \quad \text{or} \quad \phi = 54^\circ 45',$$

and at the other where

$$\cos 2\phi = \frac{1}{3} \quad \text{or} \quad \phi = 35^\circ 15',$$

the radius of curvature is  $c$ . So that arcs measured in these latitudes give  $a$  and  $c$  directly and separately. The English arc is in the position to give  $a$ , while the French arc whose mid-latitude is  $45^\circ$  gives  $\frac{1}{2}a + \frac{1}{2}c$ . The individual influence of the existing arcs in the determinations of  $a$  and  $c$  may be seen—using only round numbers—from the following calculation. Let the northern  $10^\circ$  of the Russian arc between  $70^\circ$  and  $60^\circ$  give a radius of curvature  $r_1$ ; let the English arc between  $60^\circ$  and  $50^\circ$  give  $r_2$ ; the French arc  $50^\circ$  to  $40^\circ$

giving  $r_3$ , and the ten southern degrees of the Indian arc giving  $r_4$ , then we get these equations :

$$\begin{aligned} \frac{3}{2} a - \frac{1}{2} c - r_1 &= 0, \\ a - r_2 &= 0, \\ \frac{1}{2} a + \frac{1}{2} c - r_3 &= 0, \\ -\frac{1}{14} a + \frac{2}{14} c - r_4 &= 0; \end{aligned}$$

the solution of which by least squares is

$$\begin{aligned} a &= +.3961 r_1 + .3189 r_2 + .2417 r_3 + .0432 r_4, \\ c &= +.0688 r_1 + .1645 r_2 + .2602 r_3 + .5064 r_4. \end{aligned}$$

We see here the great influence the southern part of the Indian arc has in determining  $c$ , while it has little or none in determining  $a$ .

Or more precisely—suppose each arc to have six astronomical stations, equidistant,  $5^\circ$  apart in the Russian, and  $4^\circ$  apart in the combined English and French arc ; also  $4^\circ$  apart in the Indian arc ; and let these arcs be combined by the method of least squares to determine the figure of the earth. Let  $\theta_1 \dots \theta_6$  be the latitudes of the stations in the Russian arc numbered from north to south ;  $\phi_1 \dots \phi_6$  those of the Anglo-French ;  $\psi_1 \dots \psi_6$  those of the Indian. Then if  $\delta\theta \dots, \delta\phi \dots, \delta\psi \dots$ , represent any increments to the observed latitudes, expressed in seconds, the alterations in feet that would follow in  $a$  or  $c$  are these :

RUSSIAN.		ANGLO-FRENCH.		INDIAN.	
$a$	$c$	$a$	$c$	$a$	$c$
- 117.6 $\delta\theta_1$	- 26.5 $\delta\theta_1$	- 76.2 $\delta\phi_1$	- 39.6 $\delta\phi_1$	- 5.4 $\delta\psi_1$	- 112.5 $\delta\psi_1$
- 63.7 $\delta\theta_2$	- 23.0 $\delta\theta_2$	- 40.7 $\delta\phi_2$	- 28.9 $\delta\phi_2$	+ 0.3 $\delta\psi_2$	- 71.1 $\delta\psi_2$
- 14.5 $\delta\theta_3$	- 14.5 $\delta\theta_3$	- 8.8 $\delta\phi_3$	- 14.6 $\delta\phi_3$	+ 3.0 $\delta\psi_3$	- 26.7 $\delta\psi_3$
+ 29.3 $\delta\theta_4$	- 0.6 $\delta\theta_4$	+ 19.1 $\delta\phi_4$	+ 3.9 $\delta\phi_4$	+ 3.2 $\delta\psi_4$	+ 20.3 $\delta\psi_4$
+ 67.3 $\delta\theta_5$	+ 19.3 $\delta\theta_5$	+ 43.2 $\delta\phi_5$	+ 26.3 $\delta\phi_5$	+ 1.2 $\delta\psi_5$	+ 69.5 $\delta\psi_5$
+ 99.3 $\delta\theta_6$	+ 45.4 $\delta\theta_6$	+ 63.4 $\delta\phi_6$	+ 52.8 $\delta\phi_6$	- 2.3 $\delta\psi_6$	+ 120.3 $\delta\psi_6$

4.

The meridian distance  $s$  of two points in latitudes  $\phi, \phi'$  is, as we have seen, page 111, expressed by the equation

$$\frac{s}{c} - (1 + n + \frac{5}{4} n^2) a + (3n + 3n^2) a_1 - \frac{1}{8} n^2 a_2 = 0, \quad (9)$$

in which

$$\begin{aligned} a &= \phi' - \phi, \\ a_1 &= \frac{1}{2} \sin 2\phi' - \frac{1}{2} \sin 2\phi, \\ a_2 &= \frac{1}{2} \sin 4\phi' - \frac{1}{2} \sin 4\phi. \end{aligned}$$

Suppose however that  $c, n, \phi, \phi'$  are only approximate values requiring the corrections  $\delta c, \delta n, \delta \phi, \delta \phi'$ ; then if  $F$  be the left hand side of (9), that equation becomes

$$F + \frac{dF}{dc} \delta c + \frac{dF}{dn} \delta n + \frac{dF}{d\phi} \delta \phi + \frac{dF}{d\phi'} \delta \phi' = 0,$$

which, if we neglect the small terms  $n^2 \delta \phi, n^2 \delta \phi'$  is

$$\begin{aligned} 0 &= F - \frac{s}{c} \cdot \frac{\delta c}{c} + \left\{ -(1 + \frac{5}{2}n) a + (3 + 6n) a_1 - \frac{1}{4} n a_2 \right\} \delta n, \\ &\quad + \{ 1 + n - 3n \cos 2\phi \} \delta \phi - \{ 1 + n - 3n \cos 2\phi' \} \delta \phi'. \end{aligned}$$

Let the coefficients here of  $\delta \phi, \delta \phi'$  be  $\mu, \mu'$ , and write the equation thus

$$\begin{aligned} \delta \phi' &= \frac{\mu}{\mu'} \delta \phi + \frac{F}{\mu'} - \frac{s}{c\mu'} \cdot \frac{\delta c}{c} \\ &\quad + \left\{ -(1 + \frac{5}{2}n) a + (3 + 6n) a_1 - \frac{1}{4} n a_2 \right\} \frac{\delta n}{\mu'}. \end{aligned}$$

Let the approximate values be those of a spheroid  $E_1$

$$c = 20855500, \quad n = \frac{1}{8} \frac{1}{10}, \quad (E_1)$$

and let

$$\frac{\delta c}{c} = \frac{u}{10000}, \quad \delta n = 10 v \sin 1'', \quad (10)$$

Moreover, if the corrections  $\delta \phi, \delta \phi'$  expressed in seconds be  $x, x'$ , and if we put

$$\begin{aligned} m &= \frac{s}{c\mu' \sin 1''} - \frac{1}{\mu'} (1 + n + \frac{5}{4} n^2) a'' + \frac{3n + 3n^2}{\mu' \sin 1''} a_1 \\ &\quad - \frac{15n^2 a_2}{8\mu' \sin 1''}, \end{aligned}$$

$$a = - \frac{s}{10000 c\mu' \sin 1''},$$

$$b = \frac{10}{\mu'} \left\{ -(1 + \frac{5}{2}n) a + (3 + 6n) a_1 - \frac{1}{4} n a_2 \right\},$$

$$c = \frac{\mu}{\mu'};$$

then

$$x' = m + au + bv + cx, \quad (11)$$

expresses the relation that must exist between corrections  $x$ ,  $x'$ , applied to the observed latitudes in an arc so that that arc shall belong to the ellipsoid of revolution  $E$ , whose elements are

$$c = 20855500 \left(1 + \frac{u}{10000}\right), \quad n = \frac{1}{880} + 10v \sin 1''. \quad (E)$$

Here the case is supposed of merely the two terminal latitudes being observed. But if there be any number  $n$  of observed latitudes in the arc, then the correction to the southern terminal latitude being  $x$ , each of the corrections to the remaining  $n-1$  stations will be of the form

$$m + au + bv + cx.$$

Suppose then that we have several measured arcs of meridian, in each of which are several observed latitudes: then the sum of the squares of the corrections to all the latitudes necessary to bring them into harmony with the ellipsoid ( $E$ ) is

$$\begin{aligned} U = & x_1^2 + (m_1 + a_1 u + b_1 v + c_1 x_1)^2, \\ & + (m_1' + a_1' u + b_1' v + c_1' x_1)^2, \\ & + (m_1'' + a_1'' u + b_1'' v + c_1'' x_1)^2, \\ & \quad \&c.; \\ & + x_2^2 + (m_2 + a_2 u + b_2 v + c_2 x_2)^2, \\ & + (m_2' + a_2' u + b_2' v + c_2' x_2)^2, \\ & + (m_2'' + a_2'' u + b_2'' v + c_2'' x_2)^2, \\ & \quad \&c., \end{aligned}$$

and so on; where  $x_1, x_2$  are the corrections to the southern terminal observed latitudes of the first and second arcs. And it is assumed that that ellipsoid of revolution most nearly represents the figure of the earth which renders the sum  $U$  an absolute minimum. Thus  $u, v, x_1, x_2, \dots$  are derived from the equations:

$$\begin{aligned} \frac{dU}{du} = 0, & \quad \frac{dU}{dv} = 0, \\ \frac{dU}{dx_1} = 0, & \quad \frac{dU}{dx_2} = 0, \end{aligned}$$

and so on. This resolves itself into equating the several symbolical corrections to zero and solving the equations by the method of least squares.

## 5.

It is supposed in the preceding paragraph that the data consist in meridian arcs only—but they are not now so limited. In the Indian longitudes we have a most valuable addition to the measurements on which the calculation of the figure of the earth is to depend.

Of the precision attained in these electro-telegraphic determinations we have a good means of forming an estimate by a consideration of the corrections calculated at pages 214, 215. On the whole it may be admitted that they are little inferior in weight to latitude determinations when we take into account the accidental effect of local attraction to which all are liable. We shall therefore form expressions for the easterly deflection at each of the longitude stations, and include in the  $U$  of the preceding paragraph the sum of the squares of these deflections.

In the fifth column of the following table are given the differences of longitude—as determined by electro-telegraphy and corrected as at page 214 for internal discrepancies—with reference to Bellary as a central point. The second column contains the latitudes, the third and fourth the quantities  $\psi$ ,  $\theta$ , used in the same sense as at page 267: the last column contains the longitudes as calculated with the elements of Everest's spheroid  $E'$ —in which

$$n = .00166499, \quad c = 20853284,$$

from the triangulation connecting the several stations with Bellary. The latitude of Bellary is  $\phi = 15^\circ 8' 33''$ :—

STATION.	$\phi'$	$\psi$	$\theta$	OBSERVED LONGITUDE.	SECONDS OF GEOD. LONG.
Vizagapatam	17 41 22	17 40 26	6 36	6 21 35.44	40.03
Hydrabad ...	17 30 14	17 29 22	2 48	1 35 28.29	31.53
Bombay ...	18 53 49	18 52 28	5 25	-4 6 44.00	50.74
Mangalore	12 52 14	12 53 5	3 2	-2 4 52.61	56.79
Bangalore ...	13 0 41	13 1 29	2 14	0 39 20.62	20.75
Madras ...	13 4 4	13 4 51	3 26	3 19 8.26	14.90

Let  $s$  be the distance of one of these stations from Bellary, then by (5), page 270,

$$\theta = \frac{s}{c} \cdot \frac{1-n}{(1+n)^2} (1 + 2n \cos 2\phi + n^2)^{\frac{1}{2}} (1 + \frac{2}{3} n \theta^2 \cos^2 \phi \cos^2 a),$$

where  $a$  is the azimuth. Hence, neglecting a term in  $n \theta^2 \delta \theta$ ,

$$\delta \theta = -\theta \frac{\delta c}{c} - 2\theta (1 + \sin^2 \phi - n \sin^2 2\phi - \frac{1}{3} \theta^2 \cos^2 \phi \cos^2 a) \delta n,$$

which is the alteration of  $\theta$  corresponding to very small alterations of  $c$  and  $n$ . If  $\delta \omega$  be the corresponding variation in the calculated longitude, then, see page 277, equations (13)

$$\delta \omega = -\frac{\sin \alpha'}{\cos \psi} \delta \theta = \frac{\delta \theta}{\sin \theta} \cdot \frac{\cos \phi \sin \omega}{\cos \psi};$$

substituting in this last the above expression for  $\delta \theta$ , and replacing the variations  $\delta c$ ,  $\delta n$  by their equivalents in  $u$ ,  $v$ , we get a result of the form

$$\delta \omega = Au + Bv,$$

where the values of  $A$  and  $B$  can be at once written down and calculated numerically for each station in the above table. If in the spheroid  $E$  we replace  $u$ ,  $v$  by

$$u' = -1.0626, \quad v' = -0.6172,$$

that spheroid becomes  $E'$ . If  $\omega$ , be the longitude of one of the stations in the table calculated from the triangulation on the spheroid  $E$ ,  $\omega'$  its longitude as referred to  $E'$ ;  $\omega$  the same as referred to  $E$ , then

$$\begin{aligned} \omega - \omega' &= Au + Bv, \\ \omega' - \omega &= Au' + Bv', \\ \omega &= \omega' + A(u - u') + B(v - v'). \end{aligned}$$

Omitting degrees and minutes, we obtain the following results for the longitudes of the six stations on the spheroid  $E$ :

Vizagapatam	...	...	36.083	-2.3200 $u$	-2.4008 $v$
Hydrabad	...	...	30.543	-0.5799 $u$	-0.6001 $v$
Bombay	...	...	-48.170	+1.5112 $u$	+1.5627 $v$
Mangalore	...	...	-55.528	+0.7419 $u$	+0.7678 $v$
Bangalore	...	...	20.352	-0.2339 $u$	-0.2421 $v$
Madras	...	...	12.885	-1.1841 $u$	-1.2256 $v$



Suppose that at Bellary there is a deflection  $y$  to the east while that at one of the other stations is  $y'$ : the geodetic longitude of this other station being  $\Omega + Au + Bv$  on  $E$  and its observed longitude  $\Omega'$ ,

$$\Omega' + y' \sec \phi' - y \sec \phi = \Omega + Au + Bv.$$

Thus  $y'$  is expressed in terms of  $y$  by an equation

$$y' = m + au + bv + cy.$$

The sum of the squares of the  $y$ 's at the seven longitude stations is then to be added to the  $U$  of the last paragraph, and the  $y$  treated as one of the  $x$ 's.

### 6.

We shall now write down the corrections  $x$  to the observed latitudes of the stations in the meridian arcs, pages 32–36, and the  $y$ 's for the Indian longitude stations:

Saxaford ... ..	-3.981	-7.9628 u	-5.6899 v	+0.9962 x <sub>1</sub>
North Rona ... ..	-5.356	-7.3508 u	-4.9501 v	+0.9965 x <sub>1</sub>
Great Stirling .. .	-6.140	-6.7562 u	-4.2763 v	+0.9968 x <sub>1</sub>
Kellie Law ... ..	-6.506	-6.3193 u	-3.8104 v	+0.9969 x <sub>1</sub>
Durham... ..	-6.847	-5.7884 u	-3.2777 v	+0.9972 x <sub>1</sub>
Clifton ... ..	-7.851	-5.3177 u	-2.8372 v	+0.9974 x <sub>1</sub>
Arbury... ..	-4.151	-4.8748 u	-2.4497 v	+0.9976 x <sub>1</sub>
Greenwich ... ..	-4.530	-4.6070 u	-2.2285 v	+0.9978 x <sub>1</sub>
Dunkirk ... ..	-6.545	-4.4478 u	-2.1021 v	+0.9978 x <sub>1</sub>
Dunnose ... ..	-6.969	-4.2980 u	-1.9860 v	+0.9979 x <sub>1</sub>
Pantheon ... ..	-7.823	-3.6613 u	-1.5278 v	+0.9982 x <sub>1</sub>
Carcassonne ... ..	-6.114	-1.6368 u	-0.4499 v	+0.9992 x <sub>1</sub>
Barcelona ... ..	-4.177	-0.9767 u	-0.2235 v	+0.9995 x <sub>1</sub>
Montjoux ... ..	-0.822	-0.9708 u	-0.2216 v	+0.9995 x <sub>1</sub>
Formentera ... ..	-0.000	-0.0000 u	-0.0000 v	+1.0000 x <sub>1</sub>
Fuglaenes ... ..	+2.779	-9.1041 u	-10.0005 v	+0.9961 x <sub>2</sub>
Stuor-oivi ... ..	+1.260	-8.3904 u	-8.8682 v	+0.9963 x <sub>2</sub>
Tornea... ..	+6.518	-7.3668 u	-7.3288 v	+0.9967 x <sub>2</sub>
Kilpi-maki ... ..	+1.297	-6.2198 u	-5.7382 v	+0.9972 x <sub>2</sub>
Hogland ... ..	+2.117	-5.3041 u	-4.5770 v	+0.9975 x <sub>2</sub>
Dorpat... ..	+1.060	-4.6913 u	-3.8572 v	+0.9978 x <sub>2</sub>
Jacobstadt ... ..	+4.807	-4.0167 u	-3.1193 v	+0.9981 x <sub>2</sub>
Nemesch ... ..	+2.371	-3.3516 u	-2.4506 v	+0.9984 x <sub>2</sub>
Belin ... ..	+2.768	-2.4149 u	-1.6090 v	+0.9989 x <sub>2</sub>

Kremenetz ... ..	+0.499	-1.7140 <i>u</i>	- 1.0583 <i>v</i>	+ 0.9992 <i>x</i> <sub>2</sub>
Ssuprunkowzi ... ..	+5.377	-1.2301 <i>u</i>	- 0.7175 <i>v</i>	+ 0.9994 <i>x</i> <sub>2</sub>
Wodolui ... ..	+4.008	-0.6085 <i>u</i>	- 0.3282 <i>v</i>	+ 0.9997 <i>x</i> <sub>2</sub>
Staro Nekrassowka	+0.000	-0.0000 <i>u</i>	- 0.0000 <i>v</i>	+ 1.0000 <i>x</i> <sub>2</sub>
Shahpur ... ..	-4.141	-8.5624 <i>u</i>	+ 5.1019 <i>v</i>	+ 0.9973 <i>x</i> <sub>3</sub>
Khimnana ... ..	-0.250	-7.9691 <i>u</i>	+ 4.9884 <i>v</i>	+ 0.9976 <i>x</i> <sub>3</sub>
Kaliana ... ..	+3.369	-7.6619 <i>u</i>	+ 4.9123 <i>v</i>	+ 0.9977 <i>x</i> <sub>3</sub>
Garinda ... ..	-1.979	-7.0917 <i>u</i>	+ 4.7415 <i>v</i>	+ 0.9980 <i>x</i> <sub>3</sub>
Khamor ... ..	+2.216	-6.3122 <i>u</i>	+ 4.4459 <i>v</i>	+ 0.9983 <i>x</i> <sub>3</sub>
Kalianpur ... ..	-0.933	-5.7251 <i>u</i>	+ 4.1790 <i>v</i>	+ 0.9985 <i>x</i> <sub>3</sub>
Fikri ... ..	-2.174	-4.9698 <i>u</i>	+ 3.7827 <i>v</i>	+ 0.9988 <i>x</i> <sub>3</sub>
Walwari ... ..	+5.506	-4.5109 <i>u</i>	+ 3.5137 <i>v</i>	+ 0.9989 <i>x</i> <sub>3</sub>
Danargida ... ..	+2.647	-3.5451 <i>u</i>	+ 2.8861 <i>v</i>	+ 0.9992 <i>x</i> <sub>3</sub>
Darur ... ..	+6.086	-2.8652 <i>u</i>	+ 2.3968 <i>v</i>	+ 0.9994 <i>x</i> <sub>3</sub>
Honor ... ..	-1.748	-2.4183 <i>u</i>	+ 2.0569 <i>v</i>	+ 0.9995 <i>x</i> <sub>3</sub>
Bangalore ... ..	+5.175	-1.7264 <i>u</i>	+ 1.5020 <i>v</i>	+ 0.9997 <i>x</i> <sub>3</sub>
Patchapaliam ... ..	+0.425	-1.0050 <i>u</i>	+ 0.8933 <i>v</i>	+ 0.9998 <i>x</i> <sub>3</sub>
Kudankulam ... ..	+0.000	-0.0000 <i>u</i>	+ 0.0000 <i>v</i>	+ 1.0000 <i>x</i> <sub>3</sub>
Vizagapatam ... ..	+0.6126	-2.2103 <i>u</i>	- 2.2872 <i>v</i>	+ 0.9870 <i>y</i>
Hydrabad ... ..	+2.1487	-0.5530 <i>u</i>	- 0.5723 <i>v</i>	+ 0.9880 <i>y</i>
Bombay ... ..	-3.9452	+1.4298 <i>u</i>	+ 1.4785 <i>v</i>	+ 0.9801 <i>y</i>
Mangalore ... ..	-2.8457	+0.7232 <i>u</i>	+ 0.7485 <i>v</i>	+ 1.0099 <i>y</i>
Bangalore ... ..	-0.2611	-0.2279 <i>u</i>	- 0.2358 <i>v</i>	+ 1.0094 <i>y</i>
Madras ... ..	+4.5052	-1.1535 <i>u</i>	- 1.1938 <i>v</i>	+ 1.0091 <i>y</i>
Bellary ... ..	+0.0000	+0.0000 <i>u</i>	+ 0.0000 <i>v</i>	+ 1.0000 <i>y</i>
Cape Point ... ..	-0.325	-1.6602 <i>u</i>	+ 0.2558 <i>v</i>	+ 0.9993 <i>x</i> <sub>4</sub>
Zwart Kop ... ..	+0.833	-1.6150 <i>u</i>	+ 0.2535 <i>v</i>	+ 0.9993 <i>x</i> <sub>4</sub>
Royal Observatory	-0.755	-1.5099 <i>u</i>	+ 0.2470 <i>v</i>	+ 0.9993 <i>x</i> <sub>4</sub>
Heerenlogement...	+0.304	-0.8030 <i>u</i>	+ 0.1672 <i>v</i>	+ 0.9996 <i>x</i> <sub>4</sub>
North End ... ..	+0.000	-0.0000 <i>u</i>	+ 0.0000 <i>v</i>	+ 1.0000 <i>x</i> <sub>4</sub>
Cotchesqui ... ..	+0.582	-1.1224 <i>u</i>	+ 1.0852 <i>v</i>	+ 1.0000 <i>x</i> <sub>5</sub>
Tarqui ... ..	+0.000	0.0000 <i>u</i>	+ 0.0000 <i>v</i>	+ 1.0000 <i>x</i> <sub>5</sub>

Let each of the corrections be now equated to zero and the whole treated by the method of least squares. After eliminating the *y* and the *x*'s the remaining equations are

$$\begin{aligned} 0 &= +56.6615 + 301.7624 u + 126.9252 v, \\ 0 &= -16.9677 + 126.9252 u + 221.4307 v, \end{aligned} \tag{12}$$

the solution of which gives

$$u = -0.2899, \quad v = +0.2428.$$

The values of the corrections to the observed latitudes are as in the following table:—

STATION.	CORRECTION.	STATION.	CORRECTION.
Saxaford ... ..	+ 1.453	Shahpur ... ..	- 3.550
North Rona ... ..	+ 0.081	Khimnana ... ..	+ 0.141
Great Stirling ... ..	- 0.710	Kaliana ... ..	+ 3.652
Kellie Law ... ..	- 1.089	Garinda ... ..	- 1.904
Durham ... ..	- 1.453	Khamor ... ..	+ 1.993
Clifton ... ..	- 2.486	Kalianpur ... ..	- 1.392
Arbury ... ..	+ 1.180	Fikri ... ..	- 2.949
Greenwich ... ..	+ 0.778	Walwari ... ..	+ 4.532
Dunkirk ... ..	- 1.252	Damargida ... ..	+ 1.240
Dunnose ... ..	- 1.691	Darur ... ..	+ 4.362
Pantheon ... ..	- 2.617	Honur ... ..	- 3.684
Carcassone ... ..	- 1.228	Bangalore ... ..	+ 2.993
Barcelona ... ..	+ 0.573	Patchapaliam ... ..	- 2.204
Montjoux ... ..	+ 3.927	Kudankulam ... ..	- 3.138
Formentera... ..	+ 4.524		
		Vizagapatam ... ..	+ 0.649
Fuglenaes ... ..	+ 0.029	Hydrabad ... ..	+ 2.121
Stuor-oivi ... ..	- 1.423	Bombay ... ..	- 4.050
Tornea... ..	+ 3.911	Mangalore ... ..	- 2.924
Kilpi-maki ... ..	- 1.258	Bangalore ... ..	- 0.303
Hogland ... ..	- 0.422	Madras ... ..	+ 4.499
Dorpat... ..	- 1.483	Bellary ... ..	- 0.050
Jacobstadt ... ..	+ 2.247		
Nemesch ... ..	- 0.221	Cape Point ... ..	- 0.161
Belin ... ..	+ 0.108	Zwart Kop ... ..	+ 0.983
Kremenetz ... ..	- 2.232	Royal Observatory	- 0.637
Ssuprunkowzi ... ..	+ 2.588	Heerenlogement...	+ 0.198
Wodolui ... ..	+ 1.133	North End... ..	- 0.380
Staro Negrassowka	- 2.973		
		Cotchesqui ... ..	+ 0.586
		Tarqui... ..	- 0.585

The sum of the squares of the corrections being 285.763 ..., the probable error of a single latitude is

$$\pm .674 \sqrt{\frac{285.763}{56-8}} = \pm 1''.645.$$

Moreover, if we write  $A, B$  for the absolute terms of the

last written equations (12) they may be put in the form

$$\begin{aligned} 0 &= u + \cdot 0043667 A - \cdot 0025030 B, \\ 0 &= v - \cdot 0025030 A + \cdot 0059508 B, \end{aligned}$$

so that the probable error of  $au + \beta v$  is

$$\pm 1.645 (\cdot 004367 a^2 - \cdot 005006 a\beta + \cdot 005951 \beta^2)^{\frac{1}{2}}.$$

Now  $c$  involves  $2085 u$ , and  $a$  involves  $2085 u + 2022 v$ ; hence their probable errors are respectively  $\pm 227$  and  $\pm 245$  feet. Moreover, for the number representing what is called the ellipticity, since it involves  $8.44 v$

$$2 \frac{a - c}{a + c} = \frac{1}{292.96 \pm 1.07}.$$

Finally—the values of  $a$  and  $c$  are these

$$\begin{aligned} a &= 20926202, \\ c &= 20854895, \end{aligned} \quad \mathfrak{E}.$$

and their ratio

$$c : a = 292.465 : 293.465.$$

### 7.

An examination of the corrections to the observed latitudes in the table given above, does not lead us to suppose that any of the arcs are badly represented by the spheroid just determined, that is to say, they appear to conform well to the mean figure. But to enquire more particularly into this point: suppose that for one of the arcs taken by itself only, we calculate that curve,  $\mathfrak{E}'$ , either elliptic or of the more general character

$$e = A' + 2 B' \cos 2\phi + 2 C' \cos 4\phi, \quad \mathfrak{E}'$$

which best represents that arc. Then by least squares we get  $A'$ ,  $B'$ ,  $C'$ , and also a certain correction  $\xi'$  to be added to the observed latitude  $\phi_0$  of the southern point  $S$ . Then the normal at that point of  $\mathfrak{E}'$  which corresponds to  $S$  is inclined to the equator at the angle  $\phi_0 + \xi'$ . The coordinates of a point of  $\mathfrak{E}'$  in latitude  $\phi$  are

$$\begin{aligned} x' &= (A' - B') \cos \phi + \frac{1}{3} (B' - C') \cos 3\phi + \frac{1}{5} C' \cos 5\phi + H, \\ y' &= (A' + B') \sin \phi + \frac{1}{3} (B' + C') \sin 3\phi + \frac{1}{5} C' \sin 5\phi + K, \end{aligned}$$

where  $H, K$  are disposable constants. Now  $\mathcal{E}$  being the ellipsoid we have determined as representing the mean figure of the earth, let the coordinates of a point in latitude  $\phi$  in this elliptic meridian be

$$\begin{aligned}x &= (A-B) \cos \phi + \frac{1}{3} (B-C) \cos 3\phi + \frac{1}{5} C \cos 5\phi, \\y &= (A+B) \sin \phi + \frac{1}{3} (B+C) \sin 3\phi + \frac{1}{5} C \sin 5\phi.\end{aligned}$$

On this hypothesis the observed latitude of  $S$  requires a correction  $\xi$  so that the normal to that point of the curve which corresponds to  $S$  is inclined to the equator at the angle  $\phi_0 + \xi$ .

Now if we make the values of  $x', y'$  for  $\phi = \phi_0 + \xi'$  equal respectively to the values of  $x, y$  for  $\phi = \phi_0 + \xi$ , then  $H$  and  $K$  are so determined that  $\mathcal{E}$  and  $\mathcal{E}'$  coincide at  $S$ . The normal distance between these curves in the latitude  $\phi$  is

$$\zeta = (x' - x) \cos \phi + (y' - y) \sin \phi,$$

which expresses the distance by which a point in  $\mathcal{E}'$  is farther from the centre of the earth than the corresponding point in  $\mathcal{E}$ . Let.

$$A' - A = E, \quad \frac{2}{3} (B' - B) = F, \quad \frac{2}{15} (C' - C) = G,$$

then

$$\zeta = E - F \cos 2\phi - G \cos 4\phi + H \cos \phi + K \sin \phi.$$

The values of  $\zeta$  for the large arcs are given in the adjoining table. In the case of the Anglo-French and Russian arcs, the

ANGLO-FRENCH.		RUSSIAN.		INDIAN.	
Lat.	$\zeta$	Lat.	$\zeta$	Lat.	$\zeta$
°	ft.	°	ft.	°	ft.
60	- 2.7	70	+ 4.1	32	- 4.2
58	- 3.6	68	+ 3.8	30	+ 3.8
56	- 1.8	66	+ 3.1	28	+ 8.3
54	+ 1.9	64	+ 2.0	26	+ 9.3
52	+ 6.8	62	+ 0.8	24	+ 6.9
50	+ 11.8	60	- 0.5	22	+ 2.1
48	+ 16.1	58	- 1.8	20	- 4.3
46	+ 18.8	56	- 2.9	18	- 11.1
44	+ 18.9	54	- 3.7	16	- 16.7
42	+ 15.7	52	- 4.0	14	- 19.6
40	+ 8.1	50	- 3.7	12	- 18.5
		48	- 2.7	10	- 11.8

curve  $\mathcal{C}'$  is elliptic: in the case of the Indian arc 66 latitude stations have been used to determine the curve—not restricted to the ellipse: its equation is

$$e = 20932184 - 167963.6 \cos 2\phi + 28153.2 \cos 4\phi.$$

Here we see the local form of the meridian sea-level in India with reference to the mean figure of the earth. Supposing there is no disturbance of the sea-level at Cape Comorin, then from that point northwards a depression sets in, attaining a maximum at about  $14^\circ$  latitude of nearly 20 feet: thence it diminishes, disappearing at about  $21^\circ$ . An elevation then commences, attaining at  $26^\circ$  about 9 feet: then this elevation diminishes and becomes a small depression at  $32^\circ$ . This deformation may or may not be due to Himalayan attraction; at any rate we have here an indication that that vast table-land does not produce the disturbance that might have been anticipated. But although as far north as Kaliana on the meridian of the great arc the effect of the Himalayas is not perceptible, yet at Banog  $0^\circ 57'$  north of Kaliana, the deflection northwards is about  $30''$ .

The Anglo-French arc shows a deformation nearly as large as the Indian. After all, in either case, the quantity  $\zeta$  is as small as could well be expected.

## 8.

With the values of  $a$  and  $c$  which we have obtained we find the following. If  $x, y$  be the coordinates of a point in latitude  $\phi$ , that is, its distance from the axis of revolution and from the plane of the equator

$$\begin{aligned} x &= 20944044 \cos \phi - 17865 \cos 3\phi + 23 \cos 5\phi, \\ y &= 20837084 \sin \phi - 17789 \sin 3\phi + 23 \sin 5\phi. \end{aligned}$$

Again,  $e, \rho$  being the radii of curvature in the direction of the meridian and perpendicular to the same

$$\begin{aligned} e &= 20890564 - 106960 \cos 2\phi + 228 \cos 4\phi, \\ \rho &= 20961932 - 35775 \cos 2\phi + 46 \cos 4\phi; \end{aligned}$$

$$\log \frac{1}{\rho \sin 1''} = 7.994477820 + .002223606 \cos 2\phi \\ - .000001897 \cos 4\phi,$$

$$\log \frac{1}{\rho \sin 1''} = 7.992994150 + .000741202 \cos 2\phi \\ - .000000632 \cos 4\phi.$$

If  $\delta$ ,  $\delta'$  be the lengths of a degree of latitude and of a degree of longitude

$$\delta = 364609.12 - 1866.72 \cos 2\phi + 3.98 \cos 4\phi,$$

$$\delta' = 365542.52 \cos \phi - 311.80 \cos 3\phi + 0.40 \cos 5\phi,$$

the unit throughout being the standard foot of England.

The length of the meridian quadrant is the first term of  $\rho$  above multiplied by  $\frac{1}{2}\pi$ . Expressed in inches, the ten-millionth part of the quadrant is

$$39^{\text{in}}.377786,$$

whereas the length of the legal metre is

$$39^{\text{in}}.370432.$$

## CHAPTER XIV.

### PENDULUMS.

If a heavy particle suspended from a fixed point by a fine thread, inextensible and without weight, be allowed to make small oscillations in a vertical plane under the influence of gravity, then  $l$  being the length of the thread and  $g$  the acceleration due to gravity, the time of a small oscillation *in vacuo* is expressed by the formula

$$t = \pi \left(\frac{l}{g}\right)^{\frac{1}{2}} \left(1 + \frac{1}{16} a^2\right), \quad (1)$$

where  $a$  is the maximum inclination of the thread to the vertical, and the unit of time one second. The time here expressed is the interval between two consecutive passages of the lowest point. When  $a$  does not exceed one degree the term in  $a^2$  is almost insensible. Supposing the case of indefinitely small vibrations, if the same simple pendulum be swung in two different places at which the intensities of gravity are  $g, g'$ , then the corresponding times  $t, t'$  of vibration are connected by the relation

$$t^2 : t'^2 = g' : g.$$

Or if  $n, n'$  are the numbers of vibrations made in a mean solar day

$$n^2 : n'^2 = g : g'.$$

Therefore, if a simple pendulum makes at the equator  $n$  vibrations per diem, the number  $n'$  that it will make in latitude  $\phi$  is given by the equation

$$n'^2 = n^2 \left\{1 + \left(\frac{5}{2} m - e\right) \sin^2 \phi\right\}, \quad (2)$$

Hence, if  $n, n'$  be actually observed,  $m$  and  $\phi$  being known,  $e$  the ellipticity of the earth becomes known.



So also if  $\lambda$  be the length of the pendulum which makes one vibration per second at the equator,  $\lambda'$  the length of the pendulum making one vibration per second in latitude  $\phi$

$$\lambda' = \lambda \left\{ 1 + \left( \frac{5}{2} m - e \right) \sin^2 \phi \right\}.$$

If  $\lambda, \lambda'$  be obtained from actual observation and measurement,  $e$  can be deduced as in the former case.

Among the earliest observers of the length of the seconds pendulum appear the names of Picard and Richer. In Bouguer's account of his operations in Peru we find some very careful observations of a pendulum he constructed by simply suspending a small plummet—in form two similar truncated cones united at their common base—by a thread of the aloe. This thread is strong and very fine and it is not sensibly affected by atmospheric moisture. In order to counteract any inequalities of form or density of the plummet, which was pierced along its axis for the reception of the thread, Bouguer took the precaution of using it in reversed positions: he also determined the centre of oscillation of the pendulum. The distance between the point of suspension and the centre of oscillation was measured with an iron bar prepared for the purpose, and allowance was made for the temperature and expansion of the bar. The motion of the pendulum was observed in connection with an astronomical clock: the times of coincidence of the oscillations being noted.

The first observations were made at the top of Pichincha, 15000 feet above the level of the sea, at which station Bouguer estimated that the density of the air was such that the plummet lost one 11000th part of its weight, and the observations were corrected accordingly; this he remarks was the first occasion on which a correction for buoyancy had been taken into account (*Figure de la Terre*, page 340). He then explains in a general manner—and says it can be mathematically proved—that the resistance of the air, while it increases the time of the pendulum in the descending half of an oscillation, diminishes by the same amount the time in the ascending arc, so that upon the whole, the time of vibration is not affected (Tait and Steel, *Dynamics of a Particle*, page 376). But the amplitude of the oscillations is continually diminished, and with regard to this, Bouguer remarks

that the law of diminution is a geometric progression, while the number of oscillations increases in an arithmetic progression. This law is still generally accepted as representing with sufficient approximation the phenomenon in question.

Bouguer then corrects his results for the height of the point of observation above the sea, and for the attraction of the mass of mountain or table-land between the pendulum and the sea. He shows that gravity  $g'$  at the height  $h$  has—if  $g$  be the corresponding value at the sea level in the same latitude—this value

$$g' = g \left\{ 1 - 2 \frac{h}{r} + \frac{3}{2} \frac{h}{r} \frac{\delta}{\Delta} \right\},$$

where  $r$  is the radius of the earth,  $\Delta$  its mean density, and  $\delta$  the density of the matter composing the table-land. The expression is of course an approximate one—we may regard it thus; the attraction of a circular lamina of radius  $x$ , thickness  $dy$ , and density  $\delta$ , at a point in the straight line passing through its centre perpendicular to its plane and at a distance  $y$  from the lamina is

$$2 \pi \delta \left\{ 1 - \frac{y}{(x^2 + y^2)^{\frac{1}{2}}} \right\} dy.$$

Hence it follows by integration that the attraction of a cone of height  $h$  and a radius  $k$  of base on a particle at its vertex is

$$2 \pi \delta h \left\{ 1 - \frac{h}{(h^2 + k^2)^{\frac{1}{2}}} \right\}.$$

The attraction of a segment of a sphere whose base has a radius  $k$ , and of which the height is  $h$  on a particle at its vertex is

$$2 \pi \delta h \left\{ 1 - \frac{3}{2} \frac{h}{(h^2 + k^2)^{\frac{1}{2}}} \right\}.$$

So also the attraction of a cylinder of the same radius  $k$  and height  $h$  on a point at the centre of one of its plane surfaces is

$$2 \pi \delta h \left\{ 1 - \frac{(h^2 + k^2)^{\frac{1}{2}}}{h} + \frac{k}{h} \right\}.$$

We may suppose one or other of these forms to represent the mountain on which the pendulum stands. If the radius  $k$

be very much greater than  $h$ , then in any case the attraction is very nearly  $2\pi\delta h$ . Thus the attraction at the pendulum is

$$\frac{4}{3} \frac{\pi r^3 \Delta}{(r+h)^2} + 2\pi\delta h.$$

This being  $g+dg$ , while  $g$  is the value corresponding to  $h=0$ , we get

$$\frac{dg}{g} = 2 \frac{h}{r} \left\{ 1 - \frac{3}{4} \frac{\delta}{\Delta} \right\}, \quad (3)$$

a formula revived by Dr. Thomas Young, and sometimes ascribed to him.

On comparing the observations at Quito with those at the sea-level in the same latitude, Bouguer obtained for the ratio of the density of the Cordillera to that of the earth the value  $\delta = \frac{8}{3} \frac{5}{8} \frac{0}{3} \Delta$ —an anomalous result, but one in accordance, as we shall see, with more recent observations of the same kind.

Pendulum observations were also made by de la Condamine at various places in Peru, including the mountains Pichincha and Chimborazo. Maupertuis in his operations in Sweden, referred to in Chapter I, determined the ratio of gravity at Paris to gravity at Pello, a village of the Finlanders on the Tornea river in latitude  $66^\circ 48'$ , by means of a clock invented by Graham for that purpose. The pendulum was composed of a heavy bob of the ordinary lenticular form, fitted to a flat brass rod terminated above in a transverse steel knife-edge resting on a horizontal steel plane. The temperature was ascertained by a thermometer near the pendulum, at the middle of its length. With considerable trouble the temperature in the clock room at Pello was artificially kept up for five days and nights at the same height as in the observations at Paris. The result showed an acceleration of  $59^{\text{a}}.1$  at Pello over the rate at Paris.

Borda's pendulum apparatus, by which the French astronomers determined the length of the pendulum oscillating seconds at different stations between Formentera and Dunkirk, consists of a sphere of platinum suspended by a fine wire of iron or copper attached to a knife-edge above, on which the oscillation is performed, the knife-edge resting on a steel or agate plane. This plane is fixed on a very solid support and

made perfectly level. The small cross piece forming the supporting knife-edge is so regulated by a little screw above that its own oscillations are synchronous with those of the entire pendulum: thus its effect on the movement of the pendulum is the same as if it were devoid of weight, and the point of suspension exactly in its edge. The lower end of the wire carries a small inverted cup of brass, the surface of which is ground to fit with great nicety the platinum sphere, and a little grease rubbed inside the cup is sufficient to exclude air and ensure a perfect contact with the sphere, which is thus suspended.

The sphere can be supported from any portion of its surface—and, if used in two directly opposite positions, the effect of any irregularity of form or density is eliminated from the mean of the results.

This pendulum was swung directly in front of an astronomical clock, the platinum sphere being on a level with the bob of the clock pendulum, and by means of a small telescope fixed at any convenient distance the relative movement of the two was observed. In the original experiments of Borda at Paris the wire was 12 feet long, so that the experimental pendulum made rather less than one oscillation to two of the clock. Thus about once in an hour both pendulums passed the lowest point with the same direction of motion at the same moment. These coincidences being counted the relative rates are known—and the rate of the astronomical clock is determined by transits of stars. The corrections for thermal expansion of the wire, for buoyancy of the atmosphere, and for the amplitude of the arc of oscillation required observations of the thermometer, of the barometer, and of the arc  $\alpha$  of (1). Thus the time of oscillation as actually observed is reduced to what it would have been had the pendulum been swung at the temperature  $0^{\circ}$  centigrade, in a vacuum, and in an infinitely small arc. The length of the pendulum was obtained by screwing up from below a horizontal steel plate until it made contact with the



Fig. 61.

platinum sphere, then on removing the pendulum, the distance between this plate and that on which the knife-edge rested was measured by a bar adapted especially for that purpose. Then the position of the centre of oscillation of the whole system—knife-edge, wire, and platinum sphere with its cup—was strictly calculated. During the observations the whole apparatus was cased in to prevent the disturbing effects of currents of air.

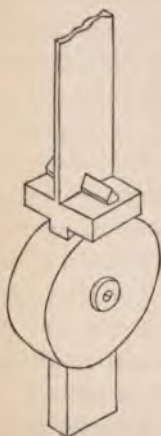
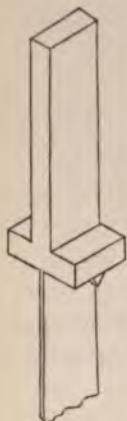

Fig. 62.

In 1818 Captain Kater determined the length of the seconds pendulum in London by an adaptation of a theorem due to Huygens, viz. that the centres of suspension and oscillation are reciprocal; in other words, that if a body be suspended by its centre of oscillation its former point of suspension becomes the centre of oscillation, and the vibrations in the two positions are executed in equal times. He accordingly constructed a pendulum of a bar of plate brass an inch and a half wide and one-eighth of an inch thick: this bar was pierced in two places to allow of the fixation of the knife-edges on which the oscillations are performed. These are made of a hard kind of steel known as wootz; they are triangular in section, and the angle on which the oscillations are performed is about  $120^\circ$ : the distance between the two knife-edges is about 39 inches. A cylinder of solid brass  $3\frac{1}{2}$  inches in diameter with a rectangular opening in the direction of its diameter is passed on to the pendulum bar and secured near one of the knife-edges. The pendulum so formed oscillates in nearly equal times in the two positions, but to ensure perfect synchronism a small sliding

weight on the bar allows the adjustment of the times to close equality. An accurate adjustment is not necessary.

If  $h_1, h_2$  be the distances of the centre of gravity from the two knife-edges—so that  $h_1 + h_2$  is the distance apart of the latter,  $t_1, t_2$  the corresponding times of oscillation in a vacuum, then, as we shall see,  $\lambda$  the length of the seconds pendulum is expressed thus

$$\lambda = \frac{h_1 + h_2}{\frac{t_1^2 h_1 - t_2^2 h_2}{h_1 - h_2}}.$$

The measurement of the distance  $h_1 + h_2$  is a troublesome operation, requiring the utmost care and precision. The determination of  $h_1 - h_2$ , or the position of the centre of gravity of the pendulum, requires only ordinary care when the times  $t_1, t_2$  are near equality. From the manner in which the times of vibration enter into the above formula it is easy to show that a greater number of oscillations should be observed with the weight down than with the weight up; in fact the whole number of oscillations intended to be observed should be distributed in parts proportional, in round numbers at least, to  $h_1, h_2$ .

The knife-edge during the swings rests on a plate of agate very carefully levelled: the fixation of this plate so that it shall be absolutely free from any participation of the pendulum's movement is a matter of the first importance. If we imagine the knife-edge near the bob to be removed, and with it the angular piece of brass to which it is immediately secured, we have Kater's so called 'invariable' pendulum; the term invariable simply implying that there are no adjustments. If with a pendulum of this description the number of oscillations it makes in one mean solar day in various places be observed, reduced to infinitely small oscillations, and corrected to a standard temperature and a standard barometric pressure, we have at once the relative intensities of gravity in those places. If to this we add a correction for reduction to the sea level, we have all that is required for an investigation of the figure of the earth, and the greater the number of stations and the greater the range of latitudes the better for that purpose.

Before noticing the various series of experiments that have

been made with this object in view we may explain how the oscillations of the pendulum are counted and reduced to an infinitely small arc. The experimental pendulum, which terminates at each end in a light tail piece (not shown in the drawing) about  $\frac{3}{4}$  inch wide, is mounted exactly in front of an astronomical clock, and those instants are observed and recorded when both pendulums pass their lowest point at the same instant. This will happen with both moving in the same or in opposite directions; the former phenomenon only can be observed, and between two such 'coincidences' the one pendulum will have made two more oscillations than the other. That the observation may be made with precision, a white paper disk equal in breadth to the tail piece of the experimental pendulum is affixed to the bob of the clock. Between the two pendulums is fixed a diaphragm with vertical edges, whose distance apart is equal to the width of the tail piece or paper disk: it is adjusted so that its vertical edges coincide with the parallel vertical planes which touch the edges of the tail piece and disk when both are at rest. Both pendulums are viewed by a telescope whose (horizontal) axis passes through the centres of the diaphragm and disk, so that if we suppose them both at rest the disk is just invisible. When the pendulums are in motion the disk, at first wholly visible, gradually disappears behind the tail piece, becoming wholly invisible: the time of this occurrence is noted as the 'disappearance.' After a few more vibrations the disk begins to reappear; this moment is noted as the 'reappearance.' The mean of the times of disappearance and reappearance is considered to be the moment of 'coincidence.' The practice of different observers varies, but usually three successive coincidences are observed at the commencement of a set of oscillations, and three again at the end. From these clock readings we can determine a mean value of the number of oscillations of the clock pendulum between consecutive coincidences: if this be  $n$ , then in the same time the experimental pendulum has made  $n \pm 2$ , which determines the relative rates. The absolute rate of the clock is of course obtained from star observations; if  $r$  be this rate, and  $N$  the number of seconds in a mean solar day,  $N + r$  is the number

of clock oscillations. Hence the number of oscillations of the experimental pendulum is

$$N + r \pm 2 \frac{N+r}{n} = N'.$$

The magnitude of the arc  $a$  is observed, by means of a scale indication, at the commencement of a set of oscillations, at the end, and sometimes at equal intervals intermediately. The time of oscillations in an arc  $a$  is equal to the time of oscillations in an infinitely small arc multiplied by  $1 + \frac{1}{18} a^2$ .

Let  $a_1$  be initial,  $a_2$  the final values, then supposing the amplitudes to diminish in geometric progression, we may put generally  $a = a_1 e^{-ct}$ , and if the time elapsed between the commencement and close be considered unity,  $a_2 = a_1 e^{-c}$ . The mean value of  $a^2$  is

$$(a^2) = a_1^2 \int_0^1 e^{-2ct} dt = -\frac{a_1^2}{2c} (e^{-2c} - 1),$$

which since  $-c = \log a_2 - \log a_1$  becomes

$$(a^2) = \frac{a_1^2 - a_2^2}{2 \log \frac{a_1}{a_2}},$$

and substituting the logarithmic series

$$\log \frac{a_1}{a_2} = 2 \left\{ \frac{a_1 - a_2}{a_1 + a_2} + \frac{1}{3} \left( \frac{a_1 - a_2}{a_1 + a_2} \right)^3 + \dots \right\},$$

we get

$$(a^2) = \frac{1}{4} (a_1 + a_2)^2 - \frac{1}{12} (a_1 - a_2)^2 - \dots$$

Hence the number of infinitely small oscillations per diem of the experimental pendulum is

$$N' + \frac{N'}{64} \left\{ (a_1 + a_2)^2 - \frac{1}{3} (a_1 - a_2)^2 \right\}, \tag{4}$$

which is the form adopted by Captain Basevi in the Indian pendulum reductions. If we take into account the next term of the logarithmic series it appears that the error of the formula (4) is

$$\frac{N'}{720} \frac{(a_1 - a_2)^4}{(a_1 + a_2)^2}.$$

Suppose for instance, as in Sabine's observations, that  $a$  initially about  $1^\circ.2$ , becomes at the close of the two hours'



swing  $0^{\circ}.6$ , this error would be very much less than a hundredth of a vibration per diem.

For a seconds pendulum the correction corresponding to a supposed uniform excursion of  $48'$  on either side of the vertical, is one vibration per diem, or more accurately

$$\frac{86400}{16} \left( \frac{48 \pi}{60.180} \right)^2 = 1.05.$$

The equation of motion of a rigid body oscillating about a horizontal axis—in a vacuum—under the influence of gravity is

$$m(h^2 + k^2) \left( \frac{du}{dt} \right)^2 - 2mgh \cos u = C,$$

where  $m$  is the mass of the body,  $mk^2$  its moment of inertia round an axis through its centre of gravity  $G$  parallel to the axis of rotation,  $h$  the distance of  $G$  from the axis of rotation and  $u$  the angle made by the plane passing through that axis and  $G$  with the vertical, so that when the body hangs at rest  $u = 0$ . If the body swings in air, and if  $m'$  be the mass of the air displaced by the pendulum, and  $h'$  the distance from the axis of the centre of gravity of the volume or figure of the pendulum, then in the above formula  $mh$  must be replaced by  $mh - m'h'$ . If at the same time,  $\lambda$  being the length of the simple pendulum oscillating once in a second at the place of observation, we replace  $g$  by  $\pi^2 \lambda$ , the equation becomes

$$(h^2 + k^2) \left( \frac{du}{dt} \right)^2 - 2\pi^2 \lambda \left( h - \frac{m'}{m} h' \right) \cos u = C.$$

If the pendulum be homogeneous,  $h' = h$ . This equation however is still only approximately true. The Chevalier I. Buat in his *Principes d'hydraulique* published in 1786, shows from numerous experiments that when a solid body moves through a fluid, a quantity of the fluid is dragged along with it: a phenomenon confirmed by the practical and theoretical investigations of Bessel in his admirable work on the pendulum *Untersuchungen über die Länge des einfachen Secundenpendels* von F. W. Bessel, Berlin, 1828. He proves that the fluid which a pendulum oscillates—being supposed of very small

density—has no other influence on the time of a small oscillation than that it increases the moment of inertia of the pendulum and diminishes the force of gravity. The above written equation must in fact be replaced by

$$(k^2 + h^2 + \frac{m'}{m} K) \left(\frac{du}{dt}\right)^2 - 2\pi^2 \lambda \left(h - \frac{m'}{m} k'\right) \cos u = C,$$

where  $K$  is a constant depending on the external form of the pendulum—which is supposed in all cases to be symmetrical with respect to a plane through  $G$  and the axis of rotation. Hence it follows that the movement of the pendulum is the same as that of a simple pendulum of the length

$$l = \frac{h^2 + k^2 + \frac{m'}{m} K}{h - \frac{m'}{m} k'} \quad (5)$$

If for  $K$  we put  $\kappa(h^2 + k^2)$ , and if the pendulum be homogeneous, the time of an oscillation is

$$t = \frac{1}{\lambda^{\frac{1}{2}}} \left\{ \frac{h^2 + k^2}{h} \right\}^{\frac{1}{2}} \left\{ \frac{1 + \frac{m'}{m} \kappa}{1 - \frac{m'}{m}} \right\}^{\frac{1}{2}} \quad (6)$$

The constant  $\kappa$  has to be determined from experiment. For this purpose Bessel swung a pendulum formed of a sphere of brass suspended by a fine wire, first in water and again in air, and determined the times of vibration. Let  $t_1, t_2$  be these times, the densities of the sphere, the water, and the air being represented by  $1 : \delta_1 : \delta_2$ . Then by (6)

$$\begin{aligned} h\lambda t_1^2 (1 - \delta_1) &= (k^2 + h^2) (1 + \delta_1 \kappa), \\ h\lambda t_2^2 (1 - \delta_2) &= (k^2 + h^2) (1 + \delta_2 \kappa), \end{aligned}$$

whence

$$1 + \kappa = \frac{t_1^2 - t_2^2}{\frac{\delta_1 t_2^2}{1 - \delta_1} - \frac{\delta_2 t_1^2}{1 - \delta_2}}$$

This experiment gave  $1 + \kappa = 1.65$ ; and varying the experiment by using a brass cylinder instead of a sphere, 1.75 was obtained. Again, he swung in air two spheres of the same diameter, 2 inches, but very different specific gravities, viz.

brass and ivory, and the comparison of the times of vibration gave  $1 + \kappa = 1.95$ : to this result he gave the preference.

The volume of the *Philosophical Transactions* for 1832 contains a very valuable memoir by Mr. Baily on the experimental determinations of this constant, his experiments extending over eighty pendulums of various descriptions.

The circumstance that a pendulum of the form of Kater's convertible pendulum is differently affected by the air according as the weight is above or below, led to the form of pendulum known as Repsold's, in which the two ends are exactly similar externally, but the cylindrical weight at one end is hollow. The centre of gravity of the figure, corresponding with the middle point of its length, is equidistant from the knife-edges, but the true centre of gravity of the mass is a different point. Let its distances from the knife-edges be  $h_1, h_2$ , and the corresponding times of an oscillation  $t_1, t_2$ . In this case  $K$  is the same for both positions of the pendulum, and  $k'$  is in either position  $\frac{1}{2}(h_1 + h_2)$ . The formula (5) becomes in this case

$$\lambda t_1^2 = \frac{h_1^2 + k^2 + \frac{m'}{m} K}{h_1 - \frac{1}{2}(h_1 + h_2) \frac{m'}{m}},$$

$$\lambda t_2^2 = \frac{h_2^2 + k^2 + \frac{m''}{m} K}{h_2 - \frac{1}{2}(h_1 + h_2) \frac{m''}{m}}.$$

Here  $m''$  is not necessarily equal to  $m'$ , except the height of the barometer be the same in the two sets of experiments. If however the observations be so arranged that the atmospheric pressure is the same when the pendulum swings on the one knife-edge as when it swings on the other, then when  $k^2$  is eliminated from the above equations,  $K$  also disappears, and we have this result

$$\lambda = \frac{h_1 + h_2}{\frac{1}{2}(t_1^2 + t_2^2) + \frac{1}{2}(t_1^2 - t_2^2) \left(1 - \frac{m'}{m}\right) \left(\frac{h_1 + h_2}{h_1 - h_2}\right)}.$$

The pendulums are so formed that  $t_1$  and  $t_2$  are almost

identical; in this case the square of  $t_1 - t_2$  is to be neglected, and

$$\lambda = \frac{h_1 + h_2}{t_1 t_2} - 2\lambda \left(1 - \frac{m'}{m}\right) \left(\frac{t_1 - t_2}{t_1 + t_2}\right) \left(\frac{h_1 + h_2}{h_1 - h_2}\right). \quad (7)$$

In the treatise on the figure of the earth by Sir G. B. Airy, in the *Encyclopædia Metropolitana*, will be found a valuable historical account of the various expeditions undertaken at different times for the purpose of measuring the relative intensities of gravity in various latitudes. The *Philosophical Transactions* for 1821-23 contain accounts of the observations of Captain Hall at *London*, *Rio Janeiro*, *Galapagos*, and *San Blas* in California, of Sir Thomas Brisbane at *Paramatta*, and of Goldingham at *Madras*. The invariable pendulum sent out to Madras was previously swung in London by Captain Kater on five days; the Madras observations extend over fifteen days: they form a connecting link between the recent Indian series and London.

Passing over the voyages of the French experimenters, Freycinet (1817-1820) and Duperrey (1822-1825), and also the Russian expedition (1826-29) under Lutke, we find in the volume entitled *An Account of experiments to determine the Figure of the Earth by means of the pendulum vibrating seconds in different latitudes*, London, 1825, an extensive series of observations by Sir Edward Sabine made with the invariable pendulum at *London*, *Sierra Leone*, *St. Thomas*, *Ascension*, *Bahia*, *Maranham*, *Trinidad*, *Jamaica*, *New York*, *Hammerfest*, *Spitzbergen*, *Greenland*, and *Drontheim*. At each station from eight to twelve or fourteen swings were observed with each of two pendulums; each swing, extending over about two hours, embraced eleven coincidences, of which the first and last were recorded. A comparison at each station of the results afforded by the two pendulums gives a measure of the accuracy of the work; it thus appears that the probable error of the final result at any station by either pendulum is  $\pm 0.11$  vibration, or taking as the result the mean of the vibrations of the two pendulums, its probable error is  $\pm 0.07$ ; a quantity surprisingly small, especially when we consider the very slender instrumental means adopted for the determination of the clock

error. In addition to these pendulums, two others of the 'invariable' pattern attached to the machinery of a clock were observed at eleven of the stations. In this method the observations are much simplified as the clock itself records the number of oscillations made per diem. This series was undertaken as an experimental enquiry into the question whether pendulums kept in motion by a driving weight could be trusted for the purpose of measuring the relative force of gravity at different places. The results certainly appeared satisfactory; the attached pendulums agreeing *inter se* as closely as did the detached: if however we compare the mean of the two attached with the mean of the two detached, at all stations, the agreement is not quite so close.

The reduction of Captain Foster's observations by Baily is given in detail in vol. vii. of the *Memoirs of the Royal Astronomical Society*. Captain Foster took with him two brass pendulums of the invariable pattern, and two others of a slightly different form, viz. a plain straight bar (one of copper, the other of iron) fitted with two knife-edges at different distances from the centre of gravity. The stations visited were *London, Greenwich, Monte Video, Staten Island, South Shetland, Cape Horn, Cape of Good Hope, St. Helena, Ascension, Fernando de Noronha, Maranham, Para, Trinidad, and Porto Bello*. The observations are very numerous—the total amount of time occupied by the swings being 2710 hours. In each swing, lasting  $2\frac{1}{2}$  or 3 hours, the first three coincidences and the last three were observed.

At Ascension one of the pendulums was swung on the top of Green Mountain, 2230 feet high. Here the number of vibrations was 85878.96, whereas the number with the same pendulum at the principal station, which was only 15 feet above the sea, was 85887.44 (reduced to the sea level). Applying Bouguer's correction (3) for height to the former result, and leaving the densities of the hill and of the earth symbolical, and then equating the so corrected vibration number to 85887.44, we get  $6.87\delta = 0.68\Delta$ , a result which would imply, as in Bouguer's experiment, that the density of the hill was extremely small.

Vol. xxxix. of *Mem. R. A. Soc.* contains a summary of a

series of experiments made with two of Repsold's Reversible Pendulums by Professor Sawitsch for the determination of the variation of gravity in Western Russia. Repsold's pendulums are in external appearance the same at both ends, symmetrical in fact, with respect to a perpendicular plane through the centre of the figure—but one bob being empty, the centre of gravity is not at the centre of figure. They swing on a portable tripod stand, and are provided with the means of making a very precise measurement of the distance between the knife-edges. When under observation the pendulum is covered with a glass case. The instrument is fully described in a Memoir by Professor Plantamour, *Expériences faites à Genève avec le pendule à réversion*, Genève et Bale, 1866. We have already shown the advantage of this form of pendulum in the almost entire elimination of the atmospheric influence.

M. Sawitsch's observations were made at twelve places, using the pendulum simply as an invariable pendulum. When the length of the seconds pendulum has to be determined a transposition of the knife-edges (which are removeable) is necessary. This was only done at one point, St. Petersburg. A somewhat serious defect in the apparatus is that the stand is put into vibration by the pendulum and thus a correction becomes necessary. This phenomenon has been very carefully investigated, both mathematically and practically, by Mr. Pierce of the U. S. C. Survey, and by MM. Cellerier and Plantamour. We find M. Sawitsch's results corrected accordingly in vol. xlv, *Mem. R. A. Soc.*, page 307.

The most extensive series of pendulum observations ever effected is that just brought to a close in India in connection with the Great Trigonometrical Survey of that country under General Walker. The observations were made by Captain Basevi, R. E., at twenty-seven stations, between  $8^{\circ}9'$  and  $33^{\circ}16'$  latitudes, his last station, Moré, being at an altitude of 15427 feet. The series was completed by Captain Heaviside, R. E., who observed at Bombay, Aden, Ismailia in Egypt, and finally at Kew Observatory. The pendulums, of which there were two, were swung at Kew before their transmission to India, both at an ordinary atmospheric pressure and in a vacuum apparatus at a pressure of one or two inches: they were also

swung at a high temperature and at a low temperature. From these observations it resulted that the number of oscillations made per diem required the correction

$$+ 0.435 (\tau - 62^\circ) + \frac{0.32 \beta}{1 + .0023 (\tau - 32^\circ)},$$

where  $\tau$  is the temperature Fahrenheit and  $\beta$  the height of the barometer in inches, in order to reduce them to the number that would have been made at  $62^\circ$  and in a vacuum.

The pendulums were, in the Indian operations, swung in a vacuum chamber, at the recommendation of the President of the Royal Society. Each swing lasted, or rather was observed, for about nine hours—at two stations they extended to twenty-three hours. At the commencement and end of each swing three consecutive coincidences were observed, and also intermediate coincidences at intervals of an hour and a half. Thermometers inside the receiver were also read at these times. Conducting the swings in a vacuum thus greatly increased the labour of the observer with but little corresponding advantage: for the object in view being the determination of the variations of gravity, the reference to a vacuum was in fact unimportant.

The change of temperature—generally an increase, seldom a decrease—during a swing, not unfrequently amounted to  $10^\circ$  Fahr.: instances of much larger variations occur, especially at Moré. The lowest mean temperature of the whole of the swings at any station was  $52^\circ$ , the highest  $92^\circ$ . The importance therefore of a very accurate knowledge of the temperature coefficient is evident, especially when we reflect that in determining the figure of the earth from pendulum observations the result obtained is dependent principally on the observations near the equator and on those farthest from it—those places in fact at which the correction for temperature is largest and most uncertain. The Indian observations include therefore a very elaborate determination of the temperature coefficient—an investigation of much difficulty.

By a comparison at each station of the results given by the two pendulums, a measure of the probable error of the final result is obtained, viz. that the probable error of the mean of

the vibration numbers of the two at any station is  $\pm 0.11$  oscillation.

Of the Indian pendulum stations, eleven exceed 1600 feet in height, Mussoorie is 6920, and Moré upwards of 15000. At these great elevations the reduction of the observations to the level of the sea becomes somewhat uncertain. Referring to page 81, if we drop the accents there affixed to  $c$  and  $e$ , and for a moment write  $\mu'$  for  $\frac{1}{3} - \mu^2$ , then  $g =$

$$\begin{aligned}
 -\frac{d\Theta}{dr} &= \frac{M}{r^2} + 3\frac{M}{r^4}c^2\mu'(e - \frac{m}{2}) - rm\frac{M}{c^3}(\frac{2}{3} + \mu'), \\
 -\frac{dg}{dr} &= 2\frac{M}{r^3} + 12\frac{M}{r^5}c^2\mu'(e - \frac{m}{2}) + m\frac{M}{c^3}(\frac{2}{3} + \mu'), \\
 \frac{dg}{g} &= -\frac{2dr}{r}\left\{1 + 3\frac{c^2}{r^2}\mu'(e - \frac{m}{2}) + \frac{3}{2}m(\frac{2}{3} + \mu')\frac{r^3}{c^3}\right\}.
 \end{aligned}$$

If here we put  $r = c(1 + \mu'e)$ , and  $dr = h$ , we have this result

$$\frac{dg}{g} = -\frac{2h}{a}\{1 + m + e \cos 2\phi\}, \tag{8}$$

where  $g$  is gravity in the latitude  $\phi$ , and  $dg$  the increment in the same in passing vertically to a height  $h$  above the sea:  $a$  is the radius of the equator. Considerable labour was expended in calculating the effect on the pendulum of the attraction of the hills on which each station is situated.

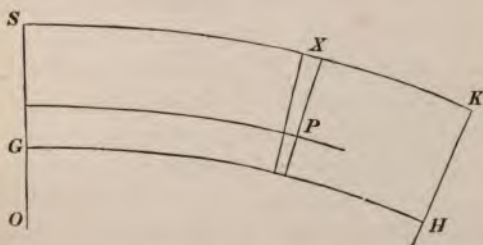

Fig. 63.

Generally, as in Bouguer's formula, it has been considered sufficient to allow for the attraction of an indefinitely extended plateau of uniform height  $h$  as though its surfaces were planes: but if we take into account the curvature of the



earth's surface, this attraction should clearly be increased: the effect of the curvature may be thus obtained.  $OGS$  being a radius of the earth drawn through the station  $S$ , and  $GH$  a section of the sea level,  $SXX$  an arc of a concentric circle, so that  $KH = SG = h$ , we require the attraction at  $S$  of the solid generated by the revolution of  $SKGH$  round  $SG$ . Let  $SK = k$ , while  $SX$  measured along the circle is  $=x$ : if also  $XP$  measured towards the centre of the earth  $=y$ , then the radius of the circle  $GH$  being  $c$ , the element of mass at  $P$  is

$$x \left( \frac{c-y}{c} \right)^2 dx dy d\phi,$$

where  $\phi$  means azimuth at  $S$ . It is assumed that  $k$  is very small compared with  $c$ , and that  $h$  is small compared with  $k$ . The coordinates of  $P$  measured along  $SG$ , and perpendicular to it are

$$y + \frac{x^2}{2c} \quad \text{and} \quad x - \frac{xy}{c}.$$

Hence the attraction at  $S$  is

$$A = 2\pi \iint \frac{\left(x - 2\frac{xy}{c}\right) \left(y + \frac{x^2}{2c}\right)}{\left(x^2 + y^2 - \frac{x^2 y}{c}\right)^{\frac{3}{2}}} dx dy;$$

or putting

$$A' = 2\pi \iint \frac{xy dx dy}{(x^2 + y^2)^{\frac{3}{2}}},$$

we have

$$\begin{aligned} A - A' &= \frac{\pi}{c} \iint \frac{x^3 - xy^2}{(x^2 + y^2)^{\frac{3}{2}}} dx dy - \frac{3\pi}{c} \iint \frac{xy^2}{(x^2 + y^2)^{\frac{3}{2}}} dx dy, \\ &= \frac{\pi}{c} \int \left\{ \frac{k^2 + 3y^2}{(k^2 + y^2)^{\frac{3}{2}}} - 3y \right\} dy + \frac{\pi}{c} \int \left\{ \frac{y^4}{(k^2 + y^2)^{\frac{3}{2}}} - y \right\} dy, \end{aligned}$$

which becomes simply  $\pi k h : c$ . But  $A'$  is the attraction of a cylinder whose length of axis is  $h$  and radius  $k$ . Hence inserting the density factor, the attraction at  $S$  is

$$A = 2\pi \delta \left\{ h + k - \sqrt{h^2 + k^2} + \frac{hk}{2c} \right\}. \quad (9)$$

This formula, otherwise obtained, was first given by Pratt and is again carefully investigated in the Indian volume. At

several of the stations the influence of the irregularities of the ground in the vicinity was also calculated: in one case only it amounts to one vibration per diem.

We shall now endeavour to obtain a value of the ellipticity from the observations referred to in the last few pages.

In attempting to solve the question by least squares, one is met at the outset with the difficulty that the errors of observation are scarcely to be extricated from local irregularities of gravity; although indeed, as far as our present knowledge goes, it would seem that the latter much exceed the former. This we gather from the circumstance that several stations have been visited by two, and some by three, different observers; and we see from the table, page 96 of Baily's Memoir, that these observers have agreed very fairly in their results at the stations in question. For instance, Sabine and Foster agree with almost precision at Maranham, Ascension, and Trinidad, and Duperrey agrees with either of these observers at Ascension; Lutke and Foster agree at St. Helena. We shall not however in investigating the ellipticity use any one station more than once: with the exceptions of Madras and St. Petersburg which, appearing in different series, it will be convenient to retain in both. We shall omit from Lutke's list St. Helena as having been visited by Foster: from the stations visited by Duperrey and Freycinet we shall omit Guam as visited also by Lutke, Rio Janeiro as visited by Captain Hall, and the Cape of Good Hope as visited by Foster; also Ascension as visited both by Foster and Sabine.

The results at Guam by Lutke are retained in preference to those of Freycinet at the same place, for the reason that Freycinet's observations there were not considered by himself satisfactory. The stations of Ualan and Bonin, where the intensity of gravity seems abnormal, will be excluded from our investigation: so also we shall exclude three stations in the Indian list: Dehra, Mussoorie, Moré.

The observations of Sabine, Foster, Goldingham, Kater, Hall, and Brisbane, are grouped together in the first of the following tables:—

STATIONS.	LAT.	VIBRA- TIONS.	STATIONS.	LAT.	VIBR- TION
	° ' "			° ' "	
Spitzbergen S	79 49 58 N	86483.42	Porto Bello ... F	9 32 30 N	86272
Greenland S	74 32 19	86470.86	Sierra Leone S	8 29 28	86267
Port Bowen F	73 13 39	86470.58	Galapagos ... H	0 32 19	86264
Hammerfest S	70 40 5	86461.28	St. Thomas ... S	0 24 41	86268
Drontheim S	63 25 54	86438.78	P. Gaunsa Lout G	0 1 49 N	86266
Unst ... K	60 45 28	86435.40	Para ... F	1 27 0 S	86263
Portsoy ... K	57 40 59	86424.70	Maranhã ... SF	2 31 39	86259
Leith Fort K	55 58 41	86418.02	Fernando de N. F	3 49 59	86271
Altona ... S	53 32 45	86408.98	Ascension ... SF	7 55 35	86272
Clifton ... K	53 27 43	86407.48	Bahia ... S	12 59 21	86272
Arbury Hill K	52 12 55	86403.68	St. Helena ... F	15 56 7	86288
London ... SF	51 31 13	86400.00	Rio Janeiro ... H	22 55 22	86294
Shanklin ... K	50 37 24	86396.40	Paramatta ... B	33 48 43	86331
New York S	40 42 43	86358.20	C. of Good Hope F	33 54 37	86331
St. Blas ... H	21 32 24	86288.80	Monte Video F	34 54 26	86334
Jamaica ... S	17 56 7	86284.80	Staten Island F	54 46 23	86415
Madras ... G	13 4 9	86272.36	Cape Horn ... F	55 51 20	86418
Trinidad ... SF	10 38 56 N	86267.15	South Shetland F	62 56 11 S	86444

	° ' "			° ' "	
Kew... ..	51 28 6	86119.19	Bombay* ... ..	18 53 46	86005
Moré ... ..	33 15 39	86024.48	Damargida ... ..	18 3 17	85996
Meean Meer ...	31 31 37	86036.36	Kodangal ... ..	17 7 57	85995
Ismailia ... ..	30 35 55	86036.01	Cocanáda* ... ..	16 56 21	85998
Mussoorie ...	30 27 41	86030.47	Nanithabad... ..	15 5 52	85990
Dehra ... ..	30 19 29	86026.89	Madras* ... ..	13 4 8	85989
Nojli ... ..	29 53 28	86029.87	Bangalore N. ...	13 4 56	85987
Kaliana ... ..	29 30 55	86029.33	Bangalore S. ...	13 0 41	85986
Dataira ... ..	28 44 5	86028.57	Mangalore*... ..	12 51 37	85988
Usira ... ..	26 57 6	86023.50	Aden* ... ..	12 46 53	85991
Pahargarh ...	24 56 7	86015.30	Pachapaliam ...	10 59 40	85984
Kalianpur ...	24 7 11	86014.87	Alleppy* ... ..	9 29 39	85985
Ahmadpur ...	23 36 21	86012.62	Mallapatti ... ..	9 28 45	85983
Calcutta*... ..	22 32 55	86012.73	Minicoy Id. ...	8 17 1	85987
Badgaon ... ..	20 44 23	86005.13	Kudankolam* ...	8 10 21	85982
Somtana ... ..	19 5 0	86000.69	Punnee* ... ..	8 9 28	85982

\* Coast stations.

3.

SAWITSCH.

STATIONS.	LAT.	VIBRA-TIONS.	STATIONS.	LAT.	VIBRA-TIONS.
	° ' "			° ' "	
Tornea ... ..	65 50 43	86590.33	Wilna ... ..	54 41 2	86549.37
Nicolaistadt ...	63 5 33	86578.25	Bélin ... ..	52 2 22	86538.73
St. Petersburg	59 56 30	86568.68	Kremenetz ...	50 6 8	86531.51
Reval ... ..	59 26 37	86567.41	Kamenetz ...	48 4 39	86524.74
Dorpat ... ..	58 22 47	86563.21	Kischinef ...	47 1 30	86519.18
Jacobstadt ...	56 30 3	86554.74	Ismail ... ..	45 20 34	86511.32

FREYCINET.

4.

DUPERREY.

	° ' "			° ' "	
Paris ... ..	48 50 14 N	86406.00	Paris ... ..	48 50 14 N	86406.85
Mowi* ... ..	20 52 7	86315.41	Toulon ... ..	43 7 20	86385.46
Rawak†... ..	0 1 34 S	86279.35			
Isle of France	20 9 56	86315.97	Isle of France	20 9 23 S	86315.87
Port Jackson	33 51 34	86351.96	Port Jackson	33 51 40	86351.21
Falkland Island	51 35 18	86414.64	Falkland Island	51 31 44	86418.12

\* Sandwich Islands.

† Near New Guinea

5.

LUTKE.

	° ' "			° ' "	
Petersburg ...	59 56 31	86273.08	Bonin Island*	27 4 12	86163.14
Sitka ... ..	57 2 58	86261.44	Guam† ... ..	13 26 21	86121.78
Petropaulowski	53 0 53	86249.83	Ualan‡... ..	5 21 16	86116.63
Greenwich ...	51 28 40	86240.18	Valparaiso ...	33 2 30	86169.23

\* Off S.E. Coast of Japan.

† Ladrone Islands.

‡ Caroline Islands.

6.

BIOT & ARAGO.

	° ' "			° ' "	
Dunkirk ... ..	51 2 10	86534.00	Figeac ... ..	44 36 45	86505.91
Clermont ... ..	45 46 48	86510.50	Formentera ...	38 39 56	86485.00
Bordeaux ... ..	44 50 26	86506.63			

The numbers in Table I agree with those of Baily, *M. R. A. S.*, vol. vii, pp. 96, 97, with the exception that the vibration numbers of Foster and Sabine are all (excluding those at Port Bowen and Altona) increased by 0.14 in order that at London the mean may be 86400. At four stations common to these two observers, viz. *London, Ascension, Trinidad, Maranham*, the differences between the vibration numbers are (Foster—Sabine) +0.28, —0.30, +0.46, —0.45, and the mean for the two observers is taken in each case.

The Indian observations are given in the second table and the Russian in the third: the last, taken from *M. R. A. S.*, vol. xliv, page 314, are converted into vibration numbers. The results of Duperrey and Freycinet are contained in the fourth table. These observers have four stations in common: if we take their results as given in Baily's Memoir, pp. 91, 92, and multiply Duperrey's vibration numbers by a factor of which the logarithm is 9.9810785, we have the numbers given in the table. The mean of the results at the four common stations is used in the subsequent calculation. The fifth table contains Lutke's results: the sixth those of Biot and Arago converted into vibration numbers; *Recueil d'observations géodésiques, &c.*, par MM. Biot et Arago, 1821, page 573.

The selection of Kew instead of London as a reference point or base for the Indian series was unfortunate, greatly diminishing the weight of those observations in the determination of the figure of the earth. For Kew is not in connection with any of the earlier pendulum stations. Great advantage would have been gained had the Indian series been extended to include at least two stations of the Sabine and Foster series, and also St. Petersburg. We may, however, though the link is not so strong as might be desired, utilize the observations of Goldingham connecting London and Madras, and thus append the Indian series to the English series<sup>1</sup>.

Again, in order to connect the Indian series with the Russian, the Russian pendulums which had been used by M. Sawitsch were sent out to India and swung at a few stations, and finally at Kew. Heaviside's result at this point being, according to Sawitsch, 440<sup>1</sup>.7170, may be considered

<sup>1</sup> An extension of the Indian Pendulum Series is under consideration.

as one of the series of Table 3. This however is an 'absolute' result, and therefore not strictly one of Sawitsch's series. It may be taken as a connection—but a somewhat weak one.

We may check the two connections just explained in the following manner. In the equation

$$\text{Greenwich} = \text{London} \left( \frac{\text{Madras}}{\text{London}} \right) \left( \frac{\text{Kew}}{\text{Madras}} \right) \left( \frac{\text{St. Petersburg}}{\text{Kew}} \right) \left( \frac{\text{Greenwich}}{\text{St. Petersburg}} \right),$$

taking London as 86400, take the first ratio on the right side from Goldingham, the second from the Indian series, the third from the Russian, the fourth from Lutke; then we get for Greenwich a vibration number within a small fraction of a vibration the same as London. This is fairly satisfactory: unfortunately, however, notwithstanding the observations of Sabine, Foster, and Baily, the exact difference of Greenwich and London is not well determined, some of the results being positive, some negative: the amount is probably not more than half a vibration.

If,  $e$  being the earth's ellipticity, we put  $\eta = \frac{1}{2}m - e$ , and if  $n_0, n$  be the vibration numbers of an invariable pendulum in latitudes  $0, \phi$ , we know that  $n^2 = n_0^2 (1 + \eta \sin^2 \phi)$ . The problem before us is to determine  $\eta$  and thence  $e$ . Let

$$\eta_0 = .0052022$$

be an approximate value of  $\eta$ , and  $m$  being  $\frac{1}{287}$ , put

$$\eta = \eta_0 + \frac{y}{10000},$$

$$e = \frac{1}{290} - \frac{y}{10000} = \frac{1}{290 + 8.4y}.$$

Let  $N_0$  be the approximate vibration number of a pendulum at the equator,  $N_0 + z$  the true number,  $N$  the vibration number of the same at a station in latitude  $\phi$ ,  $N + x$  the same vibration number corrected for local disturbance, then

$$(N + x)^2 = (N_0 + z)^2 \left\{ 1 + \eta_0 \sin^2 \phi + \frac{y}{10000} \sin^2 \phi \right\},$$

which is easily put in the form

$$x = z \frac{N_0}{N} + y \frac{N_0^2 \sin^2 \phi}{20000 N} + \frac{\eta_0 N_0^2 \sin^2 \phi}{2N} + \frac{N_0^2 - N^2}{2N}.$$



the equations (10) become

$$\begin{aligned} Y_1 &= 78.7593y + 2.8664, \\ Y_2 &= 7.8295y - 2.5995, \\ Y_3 &= 2.3138y - 4.9886, \\ Y_4 &= 6.4696y + 14.3964, \\ Y_5 &= 6.9186y + 7.1597, \\ Y_6 &= 0.4307y - 0.3743, \\ 0 &= 102.7215y + 16.4601; \end{aligned}$$

$$\therefore y = -0.160, \quad \eta = .0051862,$$

$$e = \frac{1}{2887}.$$

Secondly; assuming the connection of the English and Indian series:

$$\begin{aligned} Y_{1,2} &= 105.4021y - 48.2878, \\ Y_3 &= 2.3138y - 4.9886, \\ Y_4 &= 6.4696y + 14.3964, \\ Y_5 &= 6.9186y + 7.1597, \\ Y_6 &= 0.4307y - 0.3743, \\ 0 &= 121.5348y - 32.0946; \end{aligned}$$

$$\therefore y = 0.264, \quad \eta = .0052286,$$

$$e = \frac{1}{292.2}.$$

Thirdly; assuming the connection of the Indian and Russian only:

$$\begin{aligned} Y_1 &= 78.7593y + 2.8664, \\ Y_{2,3} &= 55.0711y - 81.1328, \\ Y_4 &= 6.4696y + 14.3964, \\ Y_5 &= 6.9186y + 7.1597, \\ Y_6 &= 0.4307y - 0.3743, \\ 0 &= 147.6493y - 57.0846; \end{aligned}$$

$$\therefore y = 0.387, \quad \eta = .0052409,$$

$$e = \frac{1}{293.3}.$$



Fourthly; assuming the connection of the English, Indian, and Russian :

$$\begin{aligned} Y_{1,2,3} &= 137.7645 y - 92.8100, \\ Y_4 &= 6.4696 y + 14.3964, \\ Y_5 &= 6.9186 y + 7.1597, \\ Y_6 &= 0.4307 y - 0.3743, \\ 0 &= 151.5834 y - 71.6282; \end{aligned}$$

$$\therefore y = 0.472, \quad \eta = .0052494,$$

$$e = \frac{1}{294.0}.$$

We may safely conclude that  $e$  lies between the limits indicated in the first and fourth solutions; and comparing the second and third solutions with the ellipticity shown at page 319 it would appear that as far as can be ascertained from our data, the ellipticity resulting from pendulum observations does not differ sensibly from that obtained from terrestrial measurements.

To each of the above solutions there is a corresponding system of quantities  $x$ , indicating the apparent excess or defect of gravity at each station of observation. If we take the system corresponding to the first solution and compare the  $x$ 's of London and Kew, we find at the former a defect of 0.91 vibrations per diem and at Kew an excess of +5.15, a difference of 6.06 vibrations, in fact between two points only ten miles apart and nearly in the same latitude. This seems inadmissible; and we are compelled to fall back on Goldingham's observations at Madras as connecting the Indian series with London. The table on the opposite page shows the excess vibrations, or excess of gravity, at the different stations according to the second solution

$$e = \frac{1}{292.2}.$$

The points marked with an asterisk were not used in the calculation.

STATIONS.	EXCESS VIBRA- TIONS.	STATIONS.	EXCESS VIBRA- TIONS.	STATIONS.	EXCESS VIBRA- TIONS.
Spitzbergen...	+ 3.09			Tornea... ..	+ 3.31
Greenland ...	- 0.50	Kew ... ..	+ 2.89	Nicolaistadt	- 0.35
Port Bowen...	+ 1.98	Moré* ... ..	- 22.08	St. Petersburg	+ 0.48
Hammerfest	- 1.41	Meean Meer	- 3.97	Reval ... ..	+ 0.91
Drontheim ...	- 3.55	Ismailia ...	- 1.08	Dorpat... ..	+ 0.41
Unst ... ..	+ 1.75	Mussoorie* ...	- 6.06	Jacobstadt ...	- 1.36
Portsoy ...	+ 1.67	Dehra* ... ..	- 9.30	Wilna ... ..	- 0.06
Leith Fort ...	+ 1.13	Nojli ... ..	- 4.82	Bélin ... ..	- 0.74
Altona... ..	+ 1.09	Kaliana ... ..	- 4.09	Kremenetz ...	- 0.50
Clifton... ..	- 0.09	Dataira ... ..	- 2.25	Kamenetz ...	+ 0.81
Arbury Hill...	+ 0.83	Usira ... ..	- 1.54	Kischinef ...	- 0.82
London ... ..	- 0.21	Pahargarh ...	- 3.54	Ismail ... ..	- 2.07
Shanklin ...	- 0.36	Kalianpur ...	- 1.54		
New York ...	+ 0.20	Ahmadpur ...	- 2.33	Paris ... ..	- 3.29
St. Blas ...	- 3.70	Calcutta ...	+ 0.79	Toulon... ..	- 1.83
Jamaica ...	+ 1.31	Badgaon ...	- 1.92	Mowi ... ..	+ 4.80
Trinidad ...	- 2.66	Somtana ...	- 2.21	Rawak... ..	- 2.61
Porte Belle ...	+ 3.85	Bombay ... ..	+ 2.84	Isle of France	+ 7.16
Sierra Leone	+ 0.66	Damargida ...	- 4.43	Port Jackson	- 0.38
Galapagos ...	+ 2.43	Kodangal ...	- 2.46	Falkland ...	- 3.85
St. Thomas ...	+ 6.86	Cocanada ...	+ 0.30		
P. G. Lout ...	+ 4.53	Namthabad...	- 3.41	Petersburg ...	- 0.13
Para ... ..	- 1.50	Madras ... ..	- 1.28	Sitka ... ..	- 1.66
Maranham ...	- 3.45	Bangalore N.	- 3.32	Petropaulows.	+ 1.59
Fernando ...	+ 8.22	Bangalore S.	- 3.82	Greenwich ...	- 2.23
Ascension ...	+ 6.15	Mangalore ...	- 1.12	Bonin Island*	+ 11.79
Bahia ... ..	- 0.98	Aden ... ..	+ 1.81	Guam ... ..	+ 4.88
St. Helena ...	+ 9.32	Pachapaliam	- 2.27	Ualan* ... ..	+ 9.93
Rio Janeiro...	- 1.41	Alleppy ... ..	+ 0.91	Valparaiso ...	- 2.41
Paramatta ...	- 0.44	Mallapatti ...	- 1.65		
C. Good Hope	- 0.80	Minecoy Id.	+ 3.49	Dunkirk ... ..	+ 1.96
Monte Video	- 1.43	Kudankolam	- 0.43	Clermont ... ..	- 1.03
Staten Island	+ 2.90	Punnce... ..	- 0.53	Bordeaux ... ..	- 1.20
Cape Horn ...	+ 1.67			Figeac ... ..	- 1.02
S. Shetland ...	+ 3.90			Formentera...	+ 1.29

The probable error of an equation—or the probable irregularity of gravity—expressed in seconds per diem is

$$\pm .674 \sqrt{\frac{767.97}{94-7}} = \pm 2.00,$$

and that of  $y$  is  $\pm 0.18$ , so that

$$e = \frac{1}{292.2 \pm 1.5}.$$

These probable errors are however too small on account of the stations omitted from the calculation.

During the progress of the pendulum observations in India General Walker called attention—first in his *Yearly Report*, 1866, and again in subsequent Reports up to 1874—to the broad fact which was gradually being brought to light, viz. that there is a very decided diminution of intensity of gravity as approach is made to the Himalayas, and that at coast stations, and especially at the Island of Minicoy, there is an excess of gravity. In the *Report* 1874, pp. 20, 21, we find notice of the crowning result of Captain Basevi's investigations—that with which his life so sadly terminated—that at the summit of the Himalayas there is a singularly great defect of gravity.

These facts are visible in the figures contained in the last table.

Kaliana<sup>1</sup> was fixed on by Sir G. Everest as the nearest approach that should be made to the base of the Himalayas for reliable geodetic observations, and in our table we see that at that station and all north of it there is a large defect of gravity, attaining at Moré an amount of  $-22$  vibrations. It is very remarkable that this is precisely the amount of the correction that had been applied for the attraction of the mountains, so that the apparent vertical attraction of the three miles of earth crust between Moré and the sea level is zero. And in fact at most of the other high stations the residual

<sup>1</sup> *An Account of the Measurement of two Sections of the Meridional Arc of India*, by Lieut.-Colonel Everest; pp. xli, xlii. At Banog the observed azimuth is affected to the extent of  $20''$  by Himalayan attraction.

discrepancy is diminished or removed if we omit the correction for the attraction of the table-land lying between the station and the sea-level.

It would seem then that these pendulum observations have established beyond question the fact—previously indicated by the astronomical observations of latitude in India—that there exists some unknown cause, or distribution of matter, which counteracts the attraction of the visible mountain masses. If it be considered too bold a speculation to surmise that there may be vast cavities under great mountain masses, then the most probable explanation is to be sought in the hypothesis of Archdeacon Pratt—and this view of the matter is favoured by General Walker in his preface to the pendulum volume<sup>1</sup>.

<sup>1</sup> *Account of the Great Trigonometrical Survey of India*, vol. v, pp. xxxii, xxxiii.

---

## NOTES AND ADDITIONS.

### NOTE, page 36.

The recently published second part of the *Mém. du Dép. Gén. de la Guerre* contains an account of the determination of the astronomical amplitude of the Algerian arc. The chain contains some 66 principal triangles, with determinations of latitude and azimuth at the extreme stations—Nemours, towards Morocco, Bone on the frontier of Tunis, and at Alger (Algiers), near the centre of the chain. The three astronomical differences of longitude corresponding to Bone-Alger, Alger-Nemours, Bone-Nemours, were inde-

penderly determined by the electro-telegraphic method, with the results shown in the following table:—

STATIONS.	NO. OF DATS.	BY DIRECT OBSERVATION.	CORRECTED FOR PERSONAL EQUATION.	PROB. ERROR.
		m. s.	m. s.	s.
Bone-Alger ...	7	18 51.222	18 51.392	± 0.011
Alger-Nemours	9	19 35.119	19 34.949	± 0.011
Bone-Nemours	8	38 26.498	38 26.328	± 0.013

The sum of the first two longitude intervals should be equal to the third: the actual discrepancy amounts to only 0<sup>s</sup>.013 which is exceedingly satisfactory.

In 1867, the theodolite displaced finally the repeating circle, and with a theodolite, or 'azimuth circle' as they call it, of the very simplest construction, the western portion of the Algerian chain was completed. The length of the arc of parallel, reduced to the latitude of 36°, is stated to be as follows:—

Bone-Alger .....	425234.7 <sup>m.</sup>
Alger-Nemours .....	441139.8

These results being dependent on an assumed figure of the earth cannot however in their present shape be used in an investigation of the figure of the earth. If we take as resulting from the calculations at page 322, 295826.4 feet as the length of a degree of the parallel of 36°, we get the following contrast:—

STATIONS.	ASTR. AMP.	GEODETIC AMP.	G—A
Bone-Alger ...	4 42 50.79	4 42 57.87	+ 7.08
Alger-Nemours	4 53 44.20	4 53 32.89	- 11.31
Bone-Nemours	9 36 34.99	9 36 30.76	- 4.23

These differences seem to point to a considerable attraction to the west at Algiers.

The trigonometrical stations in the Algerian chain are, with a few exceptions, marked by well-built pillars of stone—generally conical frustra in form—having a vertical axial aperture communicating with the centre-mark of the station.

The bases at Bone and Oran (near Nemours) are about 10 kilometres in length; the length of either of these bases, as calculated (through the intervening 88 triangles) from that of the other, differs about 16 inches from the measured length.

The azimuth circle, or theodolite, constructed by M. Brunner, of Paris, and used at the stations of the grand quadrilateral, Mulhacen, Tetica, Filhaoussen, M'Sabiha, has a diameter of 16 inches, and is read by four micrometers. The telescope is 24 inches in focal length and 2 inches in aperture.

The electric light forming the signals at the stations just named was placed in the focus of a reflector 20 inches in diameter and 24 inches focal length. This reflector is a concavo-convex lens of glass, of which the convex surface is silvered, the radii of the surfaces are so related that spherical aberration is destroyed and the reflector is practically paraboloidal. The emergent cone of white light has an amplitude of 24', which is sufficient to cover any little errors in directing the axis of the lens on the distant station. This direction is of course effected by a telescope and special mechanism, insuring the greatest precision.

In the longitude observations connecting Tetica and M'Sabiha, however, a refracting lens of eight inches diameter was found sufficient for throwing the electric light a distance of 140 miles.

The revision of the French meridian chain of Delambre and Mechain was commenced in 1870, at the base of Perpignan in the south of France, and has been completed as far as the base of Melun near Paris, an extent of 6° 30'. A few only of the old stations have been refound, thus the work is entirely new. M. Perrier has adopted the system of night observations, the light being a petroleum lamp in the focus of a refracting lens of eight inches diameter and two feet focal length. The old system of using church towers as trigonometrical stations has been abandoned, and in the woody and difficult country between Bourges and Melun the work was carried on by scaffoldings eighty and a hundred feet high. In this district the chain of triangles is double. The close of the triangles (or the error of the sum of the observed angles) indicates great precision in the work—the greatest error being 1".20, and the average 0".53.

At the central and important station of Puy de Dôme a local attraction of  $7''.0$  in latitude has been detected.

NOTE, page 59.

With reference to (13), it should be remarked that it is necessary to leave the absolute terms symbolical, only if  $f, g, h \dots$  are liable to have *any* numerical values. Otherwise, for a single set of numerical values of those coefficients,  $A, B, C \dots$  can be obtained by elimination from (12), and then, as appears from line 6, page 59,  $S$  is given by

$$0 = S + fA + gB + hC + \dots$$

NOTE, page 157.

As Kater's value of the metre, viz.  $39^{\text{in}}.37079$ , is still frequently adopted as the real length, the following remarks on the value given at page 157, namely:—

$$\text{metre} = 39^{\text{in}}.37043 \pm 0^{\text{in}}.00002$$

may be useful. Kater obtained his value from comparisons between a certain English scale and two metres brought from Paris. One of these, a platinum metre, is certified to have been compared by Arago with '*a standard metre*'—very slender authority; and about the authority for the second metre nothing is said. With respect to the comparisons, we have no information as to the errors of the thermometers used with the bars, they do not appear to have been investigated; nor is there any reference to any precaution taken for avoiding the bugbear 'constant error,' which is or should be the first and last anxiety of every observer.

The length he obtained is not of course in inches of the present standard yard. The comparisons however made at Southampton in 1864 between the standard yard and this same platinum metre, lead to the result that the '*standard metre*' to which Arago made reference had a length

$$= 39^{\text{in}}.37046.$$

The sufficiency and consistency of the authorities on which is based the value given at page 157, are doubtless beyond question.

## NOTE, page 165.

Suppose that each of the segments of a base line is measured  $n$  times, and let the results of the several measurements of the first segment be

$$s'_1, s''_1, s'''_1 \dots; \text{ the mean} = \sigma_1.$$

For the second segment let the measurements give

$$s'_2, s''_2, s'''_2 \dots; \text{ the mean} = \sigma_2,$$

and so on for each of the segments. Then,  $i$  being the number of segments, the adopted length of the base line is

$$\sigma_1 + \sigma_2 + \sigma_3 + \dots \sigma_i.$$

Put  $S^2$  to represent the sum  $(s' - \sigma)^2 + (s'' - \sigma)^2 + \dots$ , and  $\epsilon$  for 0.674, then the probable error of  $\sigma_1, \sigma_2 \dots$  are respectively

$$\pm \epsilon \left( \frac{S_1^2}{n(n-1)} \right)^{\frac{1}{2}}, \quad \pm \epsilon \left( \frac{S_2^2}{n(n-1)} \right)^{\frac{1}{2}},$$

and the probable error of the adopted length of the base

$$\pm \epsilon \left( \frac{S_1^2 + S_2^2 + S_3^2 + \dots S_i^2}{n(n-1)} \right)^{\frac{1}{2}},$$

If each segment be only twice measured, and  $\delta_1, \delta_2, \delta_3 \dots$  be the differences of the  $i$  pairs of measurements,  $S_1^2 = \frac{1}{2} \delta_1^2$ ,  $S_2^2 = \frac{1}{2} \delta_2^2$ , and so on: then the probable error of the adopted length of the base is

$$\pm \frac{\epsilon}{2} (\delta_1^2 + \delta_2^2 + \delta_3^2 + \dots \delta_i^2)^{\frac{1}{2}},$$

and the probable error of the measure of the unit of length (meaning thereby, one measuring rod, of which the first segment contains  $\sigma_1$ ) is

$$\pm \frac{\epsilon}{2} \left( \frac{\delta_1^2 + \delta_2^2 + \delta_3^2 + \dots \delta_i^2}{\sigma_1 + \sigma_2 + \sigma_3 + \dots \sigma_i} \right)^{\frac{1}{2}}.$$

## NOTE, page 199.

In the annexed figure,  $P, Z$  being the pole of the heavens, and the zenith,  $p$  is the point in which the north end of the transit-axis meets the heavens, and  $n, e, f$  the great circle traced by the collimation centre. The small circle  $da$  is that traced by one of the threads in the first position of the instrument;



on reversal, the same thread traces out the small circle  $cb$ . Let  $a, b, c, d$  be the points in which the path of a star cuts these circles so that  $aPd = I, bPc = I'$ . Then if the great

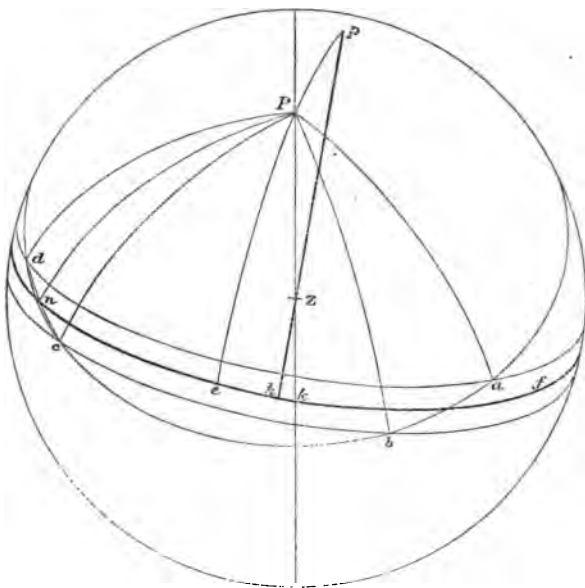

Fig. 64.

circle  $pP$  meet  $n, e, f$  in  $e$ , and if the great circle joining  $c, d$  meet  $n, e, f$  in  $n$ ,

$$nPd = \frac{1}{2}(I - I') = nPc,$$

$$ePn = \frac{1}{2}(I + I'),$$

$$ePk = H.$$

Now  $Zk = b$ : if  $Zk = b'$ ,  $\tan b' \cos a = \tan b$ . Then from the three consecutive right-angled triangles  $dPn, nPe, ePk$

$$\tan Pk = \tan Pd \cos \frac{1}{2}(I' - I) \cos \frac{1}{2}(I' + I) \sec H,$$

and  $Pk = 90^\circ - \phi + b'$ . This agrees with (17) when  $a$  and  $b$  are small.

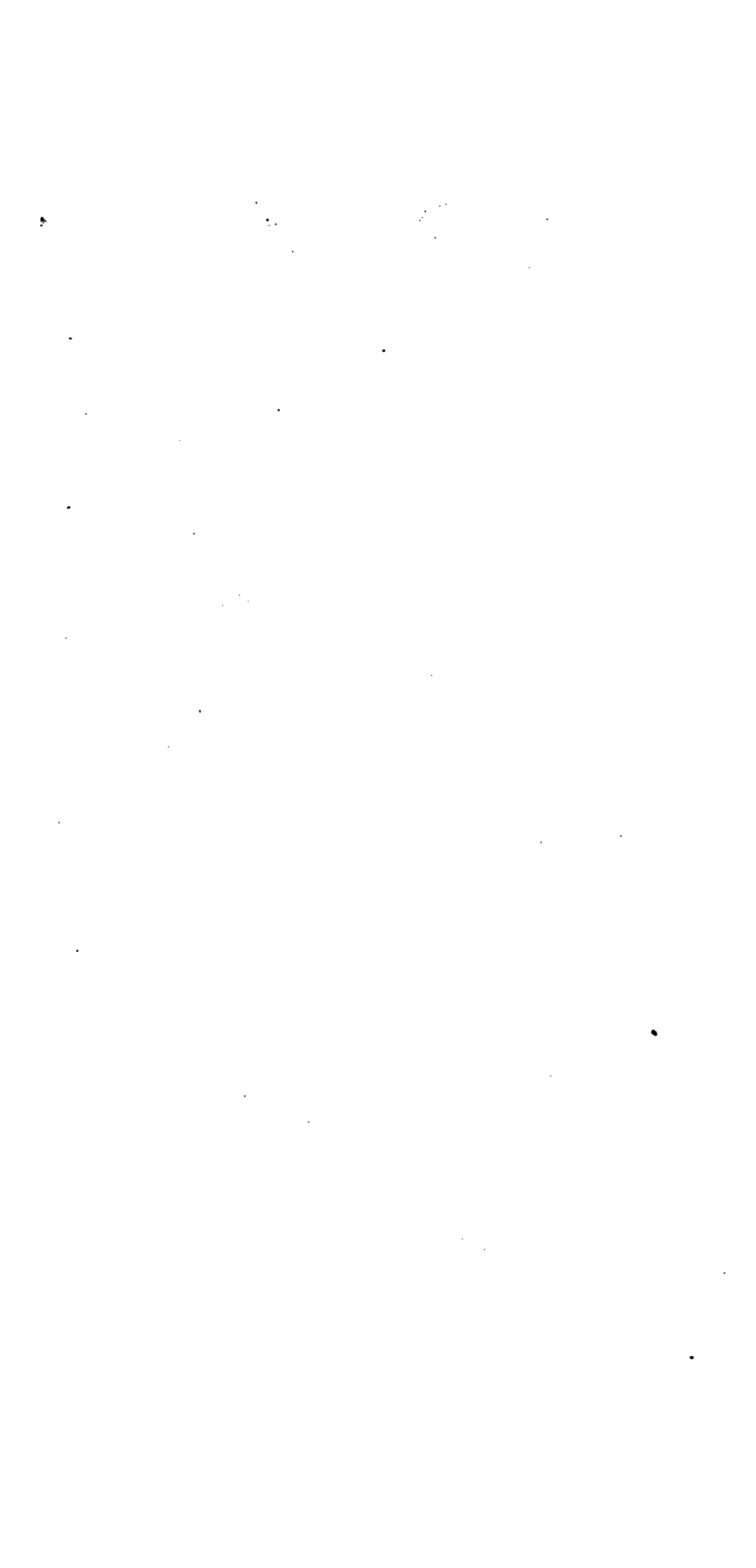

-----

-----





